

WUNDHAKEN, WUNDSPERRER

RETRACTORS

ÉCARTEURS

SEPARADORES

DIVARICATORI

Distributed in New Zealand by:



Cooper Medical Limited
57 Mahunga Drive
Mangere Bridge
Auckland 2022

ZEPF[®]
α
INSTRUMENTS



Wundhaken
 Retractors
 Écarteurs
 Separadores
 Divaricatori

**WUNDHAKEN
 WUNDSPERRER**

RETRACTORS

ÉCARTEURS

SEPARADORES

DIVARICATORI

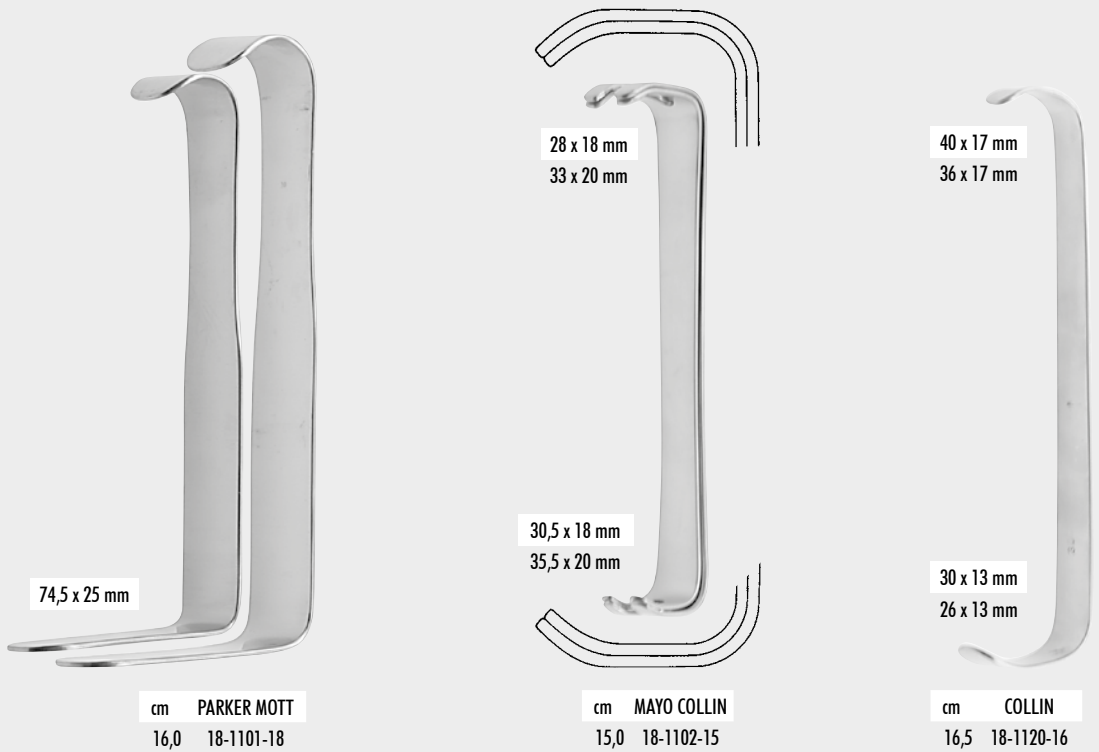
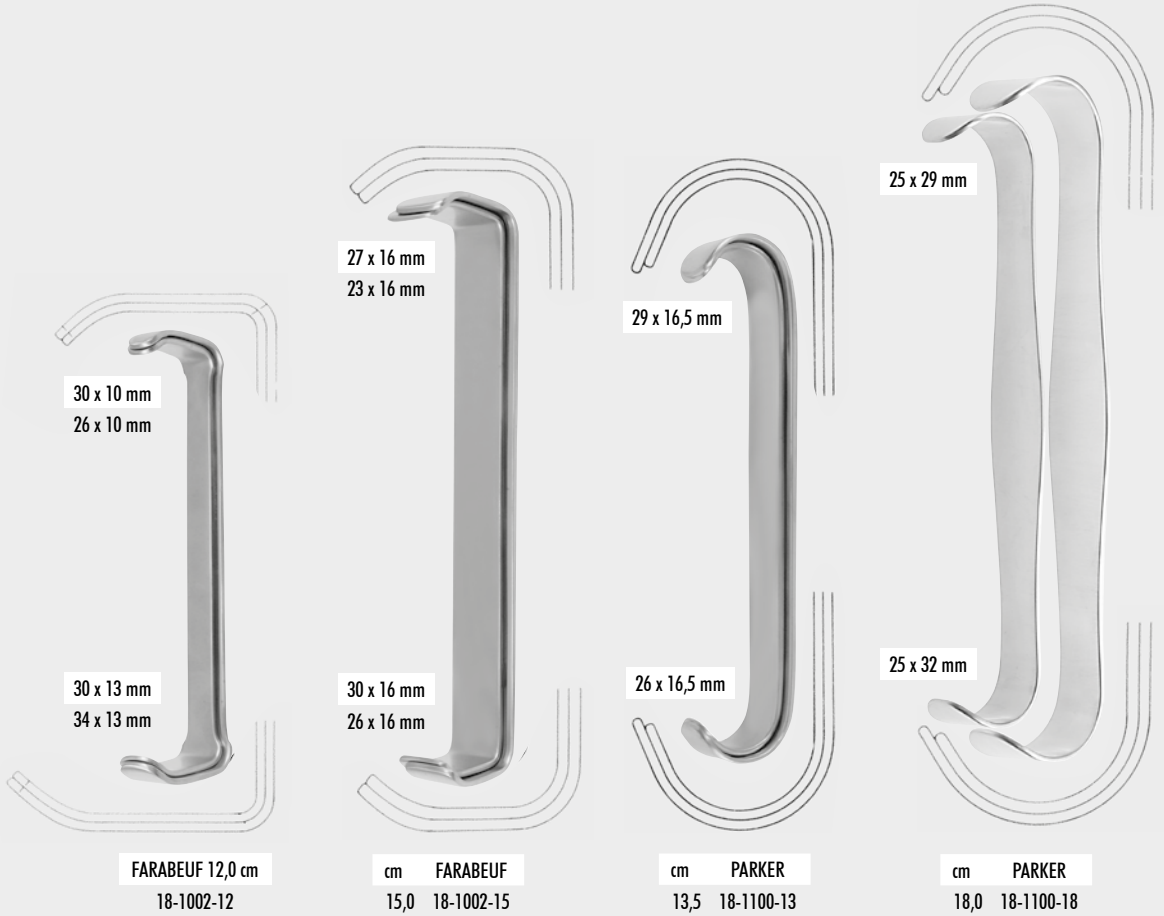

18-1002-12

18.2



ROUX compl.
18-1200-00
Set Fig. 1-3

- Fig. 1 24 x 20 mm
- Fig. 2 29 x 26 mm
- Fig. 3 35 x 29 mm
- Fig. 4 27 x 24 mm
- Fig. 1 30 x 28 mm
- Fig. 2 36 x 36 mm
- Fig. 3 38 x 43 mm
- Fig. 4 42 x 28 mm



cm	ROUX	Fig.
14,0	18-1200-14	1
15,0	18-1200-15	2
17,0	18-1200-17	3
18,0	18-1200-18	4



Fig.	mm	ROUX MAGNUS
1	25 x 28/20 x 22	18-1201-01
2	29 x 38/23 x 26	18-1201-02
3	34 x 44/29 x 29	18-1201-03



cm	ROUX Baby
13,0	18-1202-13

Wundhaken
Retractors
Écarteurs
Separadores
Divaricatori

WUNDHAKEN
WUNDSPERRER

RETRACTORS

ÉCARTEURS

SEPARADORES

DIVARICATORI



cm ROUX mini
15,0 18-1204-15



Fig.	mm	KILNER 15,0 cm
1	30 x 19/33 x 25	18-1206-01
2	35 x 29/40 x 35	18-1206-02



cm CRILE
11,5 18-1207-11
mm 7 x 7 / 4 x 5

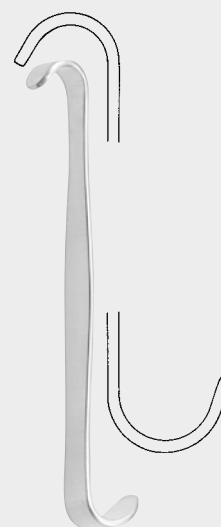

cm LUER
11,5 18-1208-11
mm 8 x 11 / 10 x 12



18-1208-11

18.3



Wundhaken
Retractors
Écarteurs
Separadores
Divaricatori

WUNDHAKEN
WUNDSPERRER

RETRACTORS

ÉCARTEURS

SEPARADORES

DIVARICATORI

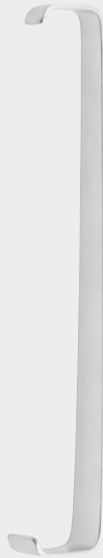

mm	LANE
13 x 19	18-1220-19
25 x 32	18-1220-32
	23,0 cm

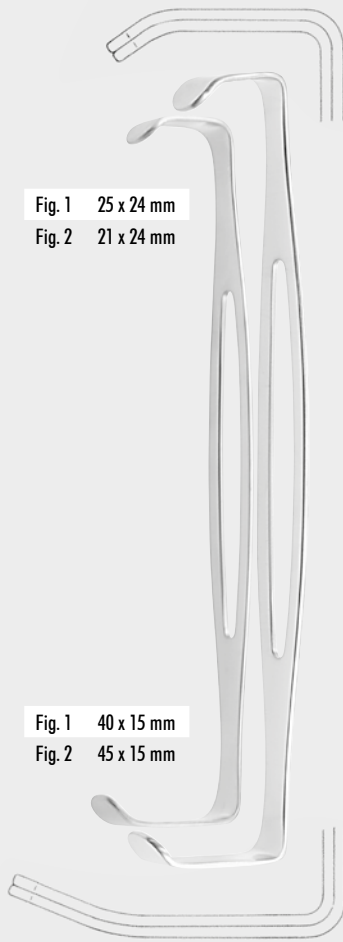

Fig. 1 25 x 24 mm
Fig. 2 21 x 24 mm

Fig. 1 40 x 15 mm
Fig. 2 45 x 15 mm

cm	US Army (PARKER LANGENBECK)
21,0	18-1301-21
	Set

Fig. 1 18-1301-01
Fig. 2 18-1301-02

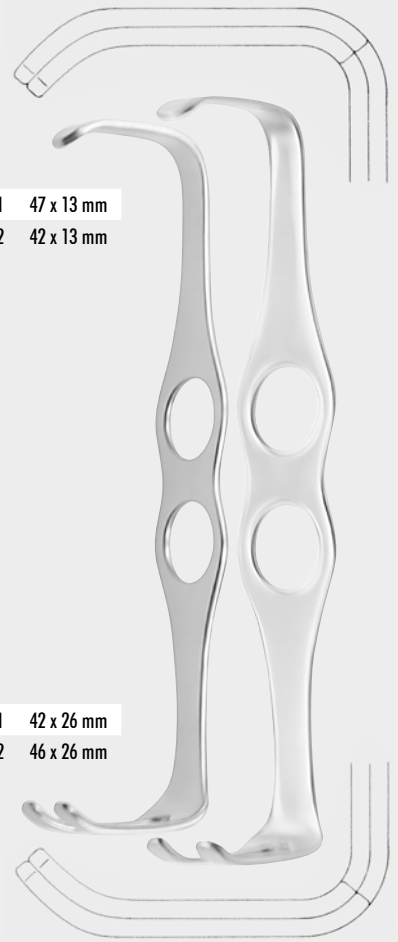

Fig. 1 47 x 13 mm
Fig. 2 42 x 13 mm

Fig. 1 42 x 26 mm
Fig. 2 46 x 26 mm

cm	MATHIEU
20,0	18-1304-20
	Set

Fig. 1 18-1304-01
Fig. 2 18-1304-02



52 x 33 / 30 x 31 mm

37 x 40 / 30 x 31 mm

cm	GOELET
19,0	18-1305-19



14,0 cm 38 x 28 mm
16,0 cm 52 x 33 mm

mm	CZERNY
32 x 22	18-1306-22



14,0 cm 32 x 21 mm
16,0 cm 36 x 27 mm

cm	COLLIN HARTMANN
14,0	18-1307-14
16,0	18-1307-16

20 x 20 mm



20 x 16 mm

cm	
20,0	18-1312-20



18-1220-19

18.4

Wundhaken
Retractors
Écarteurs
Separadores
Divaricatori

WUNDHAKEN
WUNDSPERRER

RETRACTORS

ÉCARTEURS

SEPARADORES

DIVARICATORI



18-1508-82

18.5



49 x 38 mm
28 x 20 mm

36 x 28 mm
63 x 49 mm

RICHARDSON EASTMAN		cm
Set	18-1400-00	
Fig. 1	18-1400-01	26,0
Fig. 2	18-1400-02	28,0



RICHARDSON	
18-1500-01 - 18-1500-03	



18-1500-01
28 x 20 mm



18-1500-02
36 x 28 mm



18-1500-03
44 x 38 mm

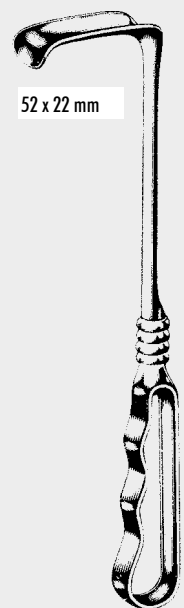

52 x 22 mm

RICHARDSON	
18-1500-04	



RICHARDSON Grip	
18-1502-25	20 x 25 mm
18-1502-31	25 x 31 mm
18-1502-38	38 x 38 mm
18-1502-51	19 x 51 mm
18-1502-64	41 x 64 mm



18-1506-26	65 x 50 mm
18-1506-50	50 x 40 mm
18-1506-65	65 x 75 mm
18-1506-70	70 x 65 mm
18-1506-71	70 x 50 mm
18-1506-90	90 x 76 mm

KELLY 26,0 cm
18-1506-26 - 18-1506-90



18-1508-51	38 x 51 mm
18-1508-64	51 x 64 mm
18-1508-76	64 x 76 mm
18-1508-82	70 x 82 mm

KELLY Grip 26,0 cm
18-1508-51 - 18-1508-82



Wundhaken
 Retractors
 Écarteurs
 Separadores
 Divaricatori

**WUNDHAKEN
 WUNDSPERRER**



mm COPE 18,0 cm
 8 x 11 18-1590-18



mm x mm HOUSE 15,0 cm
 6,5 x 20/9 x 25 18-1592-15



cm RAGNELL DAVIS
 14,0 18-1598-14

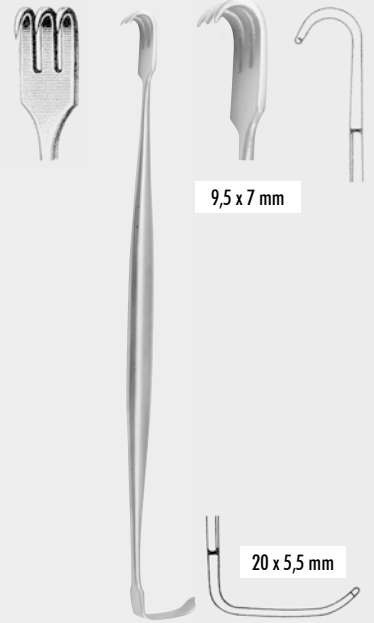

cm SENN MILLER
 17,0 18-1600-17 18-1601-17

RETRACTORS

ÉCARTEURS

SEPARADORES

DIVARICATORI

Wundhaken, Bauchspatel
 Retractors, Abdominal Spatula
 Écarteurs, Spatules abdominales
 Separadores, valvas abdominales
 Divaricatori, Spatole addominali



8 x 7 mm



8 x 7 mm



22 x 7 mm

SENN MILLER Baby



18-1602-15



18-1603-15

15,0 cm



mm CHEVRET

40 18-1604-40

60 18-1604-60

80 18-1604-80

30,0 cm



RIBBON

18-1698-06 6 x 200 mm

18-1698-07 7 x 200 mm

18-1698-09 9 x 200 mm

18-1698-95 9,5 x 200 mm soft

18-1698-12 12 x 200 mm

18-1698-13 13 x 200 mm soft

18-1698-17 17 x 200 mm

18-1698-18 19 x 200 mm soft

18-1698-19 16 x 200 mm soft

18-1698-20 20 x 200 mm

18-1698-24 25 x 200 mm

18-1698-25 25 x 250 mm

18-1698-26 25 x 200 mm soft



18-1590-18

18.6



konkav
concave
concaua
concave
concava



konvex
convex
convexa
convexe
convessa



mm	CUSHING, 18,0 cm
7/ 9	18-1670-07
11/13	18-1670-11
15/18	18-1670-15
18/22	18-1670-18

mm	OLIVECRONA, 18,0 cm
7/ 9	18-1672-07
11/13	18-1672-11
15/18	18-1672-15
18/22	18-1672-18

mm	OLIVECRONA, 18,0 cm
7/ 9	18-1674-07
11/13	18-1674-11
15/18	18-1674-15
18/22	18-1674-18

mm	HEIFETZ
8	18-1680-08
11	18-1680-11
14	18-1680-14
17	18-1680-17
20	18-1680-20

WUNDHAKEN
WUNDSPERRER

Spatel
Spatulas
Spatules
Espátulas
Spatole

RETRACTORS

ÉCARTEURS

SEPARADORES

DIVARICATORI

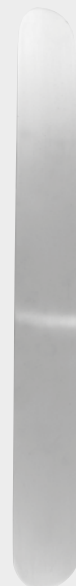
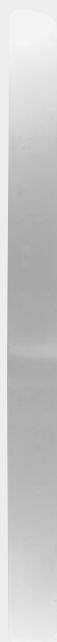

mm	cm	mm	SCOVILLE
9,0	18-1684-20	20,0	10/ 13
12,0	18-1685-20	20,0	16/19
12,0	18-1686-25	25,0	

mm	SCOVILLE
10/ 13	18-1690-10
16/19	18-1690-16

RIBBON	
18-1700-13	13 x 330 mm
18-1700-19	19 x 330 mm
18-1700-25	25 x 330 mm
18-1700-30	30 x 330 mm
18-1700-32	32 x 330 mm
18-1700-40	40 x 330 mm
18-1700-50	50 x 330 mm
18-1700-75	75 x 330 mm

mm	CAIRNS
6	18-1702-06
8	18-1702-08
10	18-1702-10
11	18-1702-11
13	18-1702-13
16	18-1702-16
19	18-1702-19
25	18-1702-25

HABERER	
18-1704-17*	17/25 x 200 mm
18-1704-25	25/30 x 250 mm
18-1704-37	37/45 x 300 mm
18-1704-50	50/40 x 305 mm

* (TUFFIER)

20,0 cm



18-1704-50

18.7

Bauchspatel, Wundhaken
 Abdominal Spatula, Retractors
 Spatule abdominale, Écarteurs
 Espátula abdominal, Separadores
 Spatola addominale, Divaricatori

**WUNDHAKEN
 WUNDSPERRER**

RETRACTORS

ÉCARTEURS

SEPARADORES

DIVARICATORI



cm REVERDIN
 28,0 18-1705-28



DEAVER
 18-1800-19
 19 x 180 mm



DEAVER
 18-1801-22
 22 x 215 mm



DEAVER
 18-1801-25
 25 x 230 mm



DEAVER
 18-1803-25
 25 x 300 mm



DEAVER
 18-1805-25
 25 x 330 mm



DEAVER
 18-1807-25
 25 x 360 mm



DEAVER
 18-1807-38
 38 x 300 mm



DEAVER
 18-1807-50
 50 x 300 mm



DEAVER
 18-1807-75
 75 x 300 mm



DEAVER Grip	
18-1809-25	25 x 310 mm
18-1809-38	38 x 310 mm
18-1809-50	50 x 310 mm
18-1809-75	75 x 310 mm
18-1810-00	100 x 310 mm



THORLAKSON 33,0 cm	
18-1890-40	170 x 45 mm
18-1890-50	170 x 50 mm
18-1890-65	170 x 65 mm



THORLAKSON 25,0 cm	
18-1892-25	125/175 x 25 mm
18-1892-35	125/175 x 35 mm
18-1892-50	125/175 x 50 mm

Wundhaken
Retractors
Écarteurs
Separadores
Divaricatori

**WUNDHAKEN
WUNDSPERRER**

RETRACTORS

ÉCARTEURS

SEPARADORES

DIVARICATORI



26,0 cm	
18-1894-29	205 x 29 mm



HARRINGTON	
18-1901-25	25 x 230 mm
18-1901-40	40 x 320 mm
18-1901-62	62 x 320 mm

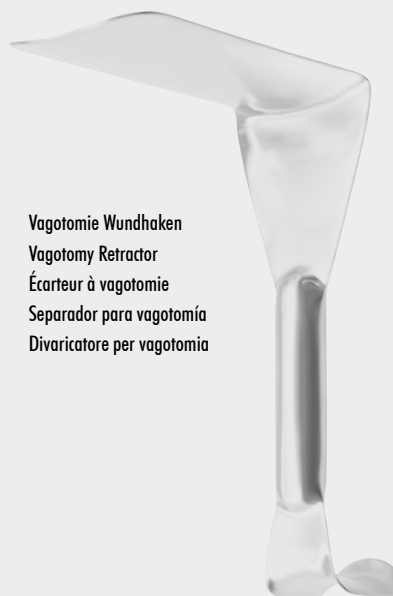

Vagotomie Wundhaken
Vagotomy Retractor
Écarteur à vagotomie
Separador para vagotomia
Divaricatore per vagotomia

cm	WEINBERG
24,0	18-1908-00
	90 x 160 mm

ZEPF®
α
INSTRUMENTS

18-1908-00

18.9

Wundhaken
 Retractors
 Écarteurs
 Separadores
 Divaricatori

**WUNDHAKEN
 WUNDSPERRER**

RETRACTORS

ÉCARTEURS

SEPARADORES

DIVARICATORI



cm GAEFE
 16,0 18-1998-16



cm GAEFE
 16,0 18-1999-16



GAEFE
 18-2100-12



GAEFE
 18-2101-12



GUTHRIE
 18-2102-01



GUTHRIE
 18-2102-02

16,0 cm 18-2100-01 - 18-2102-02



cm FRAZIER
 13,0 18-2104-13
 18,0 18-2104-18



18-2106-01



18-2106-02
 2 mm



18-2106-05
 5 mm



18-2106-07
 7 mm



18-2106-10
 10 mm

cm JOSEPH
 16,0 18-2106-01 - 18-2106-10



mm KLEINERT KUTZ
 3 18-2150-03
 5 18-2150-05
 7 18-2150-07
 13,0 cm

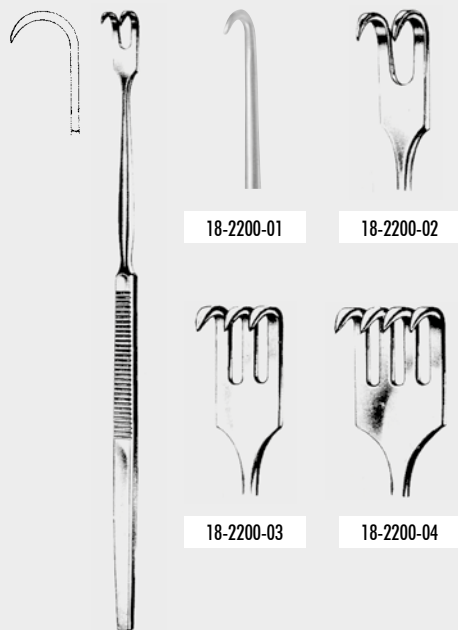

18-2200-01

18-2200-02

18-2200-03

18-2200-04

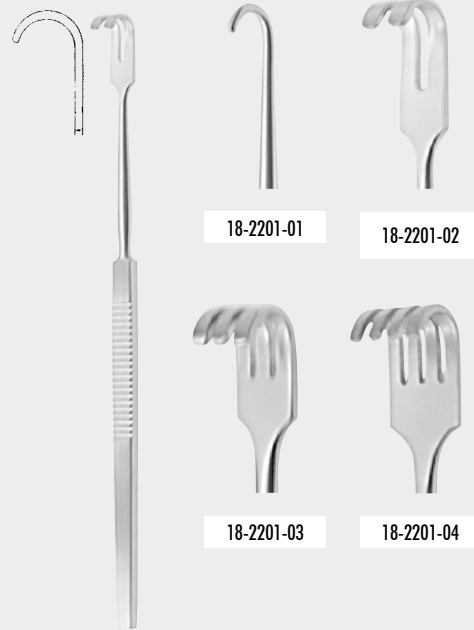

18-2201-01

18-2201-02

18-2201-03

18-2201-04

16,0 cm 18-2200-01 - 18-2200-04

16,0 cm 18-2201-01 - 18-2201-04

Wundhaken
Retractors
Écarteurs
Separadores
Divaricatori

WUNDHAKEN
WUNDSPERRER

RETRACTORS

ÉCARTEURS

SEPARADORES

DIVARICATORI

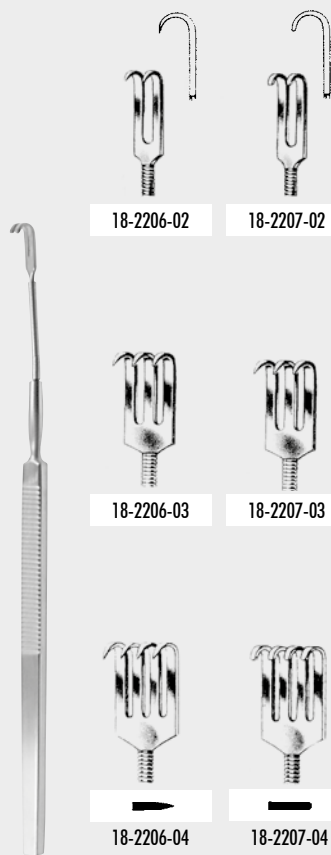

18-2206-02

18-2207-02

18-2206-03

18-2207-03

18-2206-04

18-2207-04

16,0 cm 18-2206-02 - 18-2207-04

flexibel
flexible
flessibile



mm
8 18-2300-08

mm
14 18-2300-14

mm
10 18-2300-10

mm
16 18-2300-16

mm
12 18-2300-12

mm
18 18-2300-18

16,0 cm 18-2210-04 18-2211-04

cm DESMARRES 16,0 18-2300-08 - 18-2300-18

Auch Lidhalter
Also Eyelid Retractors
Aussi écarteurs de paupières
También separadores de párpados
Anche divaricatori di palpebre



18-2300-18

18.11



Wundhaken
Retractors
Écarteurs
Separadores
Divaricatori

WUNDHAKEN
WUNDSPERRER



CUSHING 25,0 cm	
18-2301-11	11 x 14 mm
18-2301-13	13 x 18 mm
18-2301-15	15 x 22 mm



mm	
8	18-2302-08
8	18-2304-08



mm	
14	18-2302-14
14	18-2304-14



mm	
10	18-2302-10
10	18-2304-10

mm	
16	18-2302-16
16	18-2304-16



mm	
12	18-2302-12
12	18-2304-12

mm	
18	18-2302-18
18	18-2304-18



cm	23,5 cm
20,0	18-2306-23

RETRACTORS

ÉCARTEURS

SEPARADORES

DIVARICATORI

cm	CUSHING
20,0	18-2302-08 - 18-2302-18
24,0	18-2304-08 - 18-2304-18

Hilushaken - Hilar Retracto
Écarteurs hilaires - Separadores hilares
Divaricatori ilari



x= mm	16,0 cm
12	18-2308-12
14	18-2308-14
16	18-2308-16
18	18-2308-18



x=mm	KÖNIG 17,0 cm
13	18-2310-13
16	18-2310-16



cm	CUSHING
20,0	18-2314-20



cm	CUSHING
21,5	18-2316-21



mm	KIRKLAND 13,5 cm
5	18-2320-05
7	18-2320-07
10	18-2320-10
12	18-2320-12
15	18-2320-15

biegsam
malleable
malléables
maleables
malleabili



18-2301-11

18.12

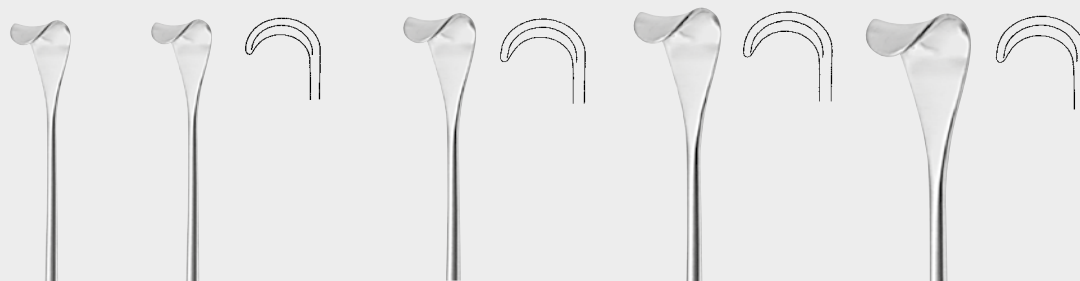

mm
8 18-2322-08

mm
11 18-2322-11

mm
13 18-2322-13

mm
15 18-2322-15

biegsam - malleable - malléables - maleables - malleabili



mm
17 18-2322-17

mm
20 18-2322-20

mm
23 18-2322-23

biegsam - malleable - malléables - maleables - malleabili



cm GIL VERNET
24,0 18-2322-08 - 18-2322-23

Wundhaken
Retractors
Écarteurs
Separadores
Divaricatori

WUNDHAKEN
WUNDSPERRER

RETRACTORS

ÉCARTEURS

SEPARADORES

DIVARICATORI

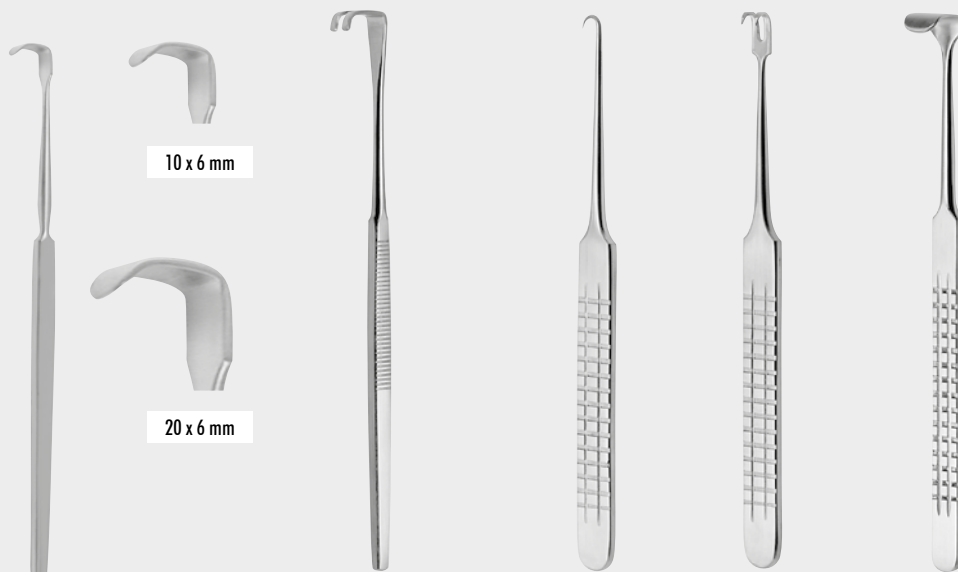

10 x 6 mm

20 x 6 mm

SENN-GREEN 14,0 cm

10 x 6 mm 18-2400-10

20 x 6 mm 18-2400-20

16,0 cm

14 x 8 mm 18-2402-14

16,0 cm

18-2404-01

16,0 cm

18-2404-02

16,0 cm

10 x 13 mm 18-2405-13



18-2405-19

18.13



Wundhaken
 Retractors
 Écarteurs
 Separadores
 Divaricatori

**WUNDHAKEN
 WUNDSPERRER**

RETRACTORS

ÉCARTEURS

SEPARADORES

DIVARICATORI



mm	LANGENBECK GREEN 16,0 cm
16 x 6	18-2406-16
24 x 6	18-2406-24

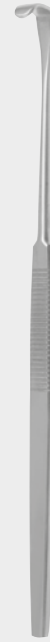

cm	LANGENBECK mini
16,0	18-2407-10 - 18-2407-22



mm	
10 x 6	18-2407-10

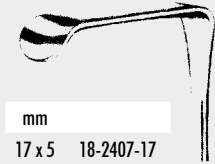

mm	
17 x 5	18-2407-17

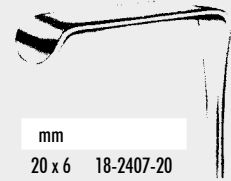

mm	
20 x 6	18-2407-20

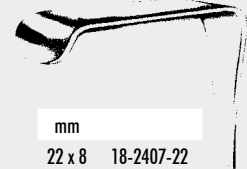

mm	
22 x 8	18-2407-22



mm	MOBERG 17,0 cm
14 x 5	18-2409-14
16 x 5	18-2409-16
25 x 6	18-2409-25



cm	KOENIG
17,0	18-2411-13 - 18-2411-16



18-2411-13
13 x 13 mm



18-2411-16
13 x 16 mm



18-2406-16

18.14

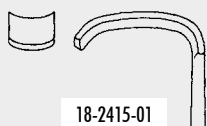

18-2415-01

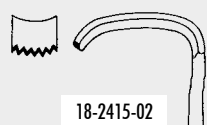

18-2415-02



cm STRANDELL STILLE
19,0 18-2415-01 - 18-2415-02



Fig. BROM 19,5 cm
1 18-2416-01
2 18-2416-02



12,0 cm
18-2418-12



BERGMANN 14,0 cm
18-2420-14

Wundhaken
Retractors
Écarteurs
Separadores
Divaricatori

WUNDHAKEN
WUNDSPERRER

RETRACTORS

ÉCARTEURS

SEPARADORES

DIVARICATORI



18-2700-02



18-2701-02



18-2700-03



18-2701-03



18-2700-04



18-2701-04



18-2700-06



18-2701-06



cm VOLKMANN
11,5 18-2700-02 - 18-2701-06



WUNDHAKEN
WUNDSPERRER



VOLKMANN 21,5 cm
18-2800-01 - 18-2803-06



18-2800-01



18-2800-02



18-2800-03



18-2800-04



18-2800-06

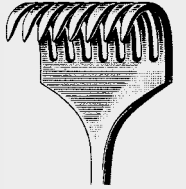

18-2800-08



18-2801-01



18-2801-02



18-2801-03



18-2801-04



18-2801-06

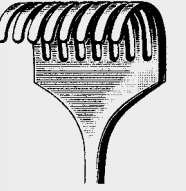

18-2801-08



18-2803-01



18-2803-02



18-2803-03



18-2803-04



18-2803-06

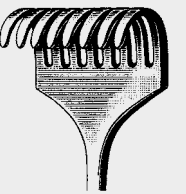

18-2803-08

RETRACTORS

ÉCARTEURS

SEPARADORES

DIVARICATORI



KOCHER 22,0 cm
18-2810-01 - 18-2813-08

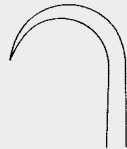

18-2810-01



18-2810-02



18-2810-03



18-2810-04

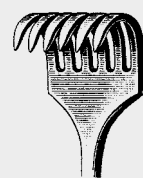

18-2810-06

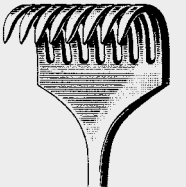

18-2810-08

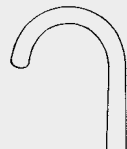

18-2811-01



18-2811-02



18-2811-03



18-2811-04

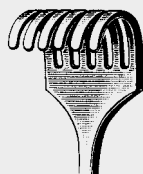

18-2811-06

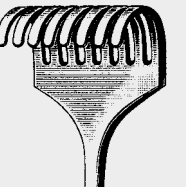

18-2811-08

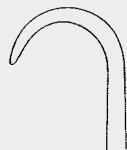

18-2813-01



18-2813-02



18-2813-03



18-2813-04



18-2813-06

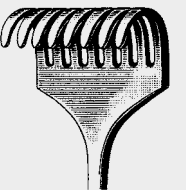

18-2813-08



18-2800-01

18.16

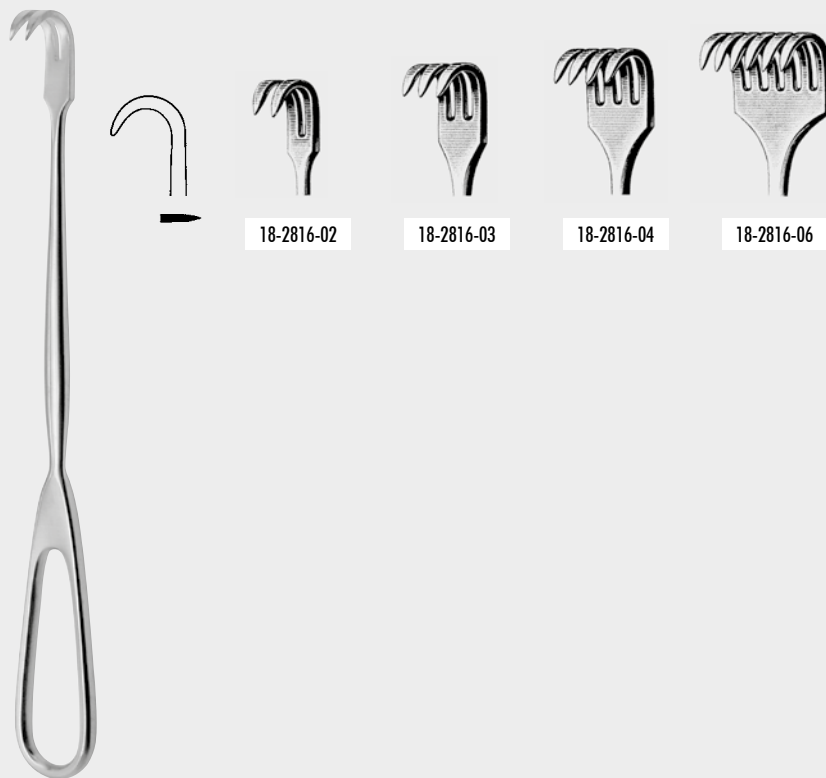

cm VOLKMANN US
22,5 18-2816-02 - 18-2816-06

WUNDHAKEN
WUNDSPERRER

RETRACTORS

ÉCARTEURS

SEPARADORES

DIVARICATORI

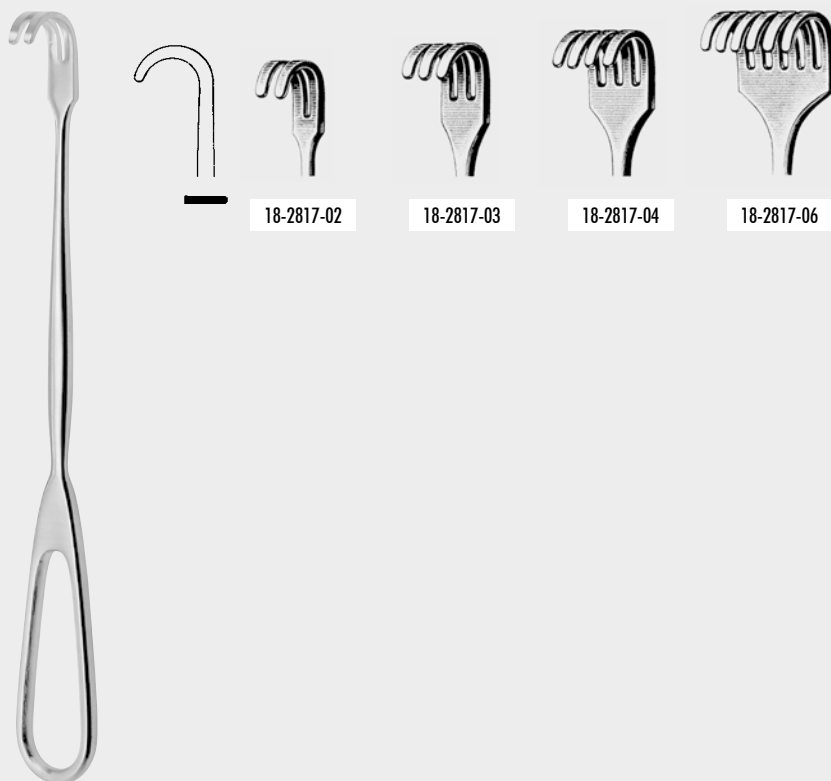

cm VOLKMANN US
22,5 18-2817-02 - 18-2817-06

ZEPF[®]
α
INSTRUMENTS

18-2817-06

18.17

WUNDHAKEN
WUNDSPERRER

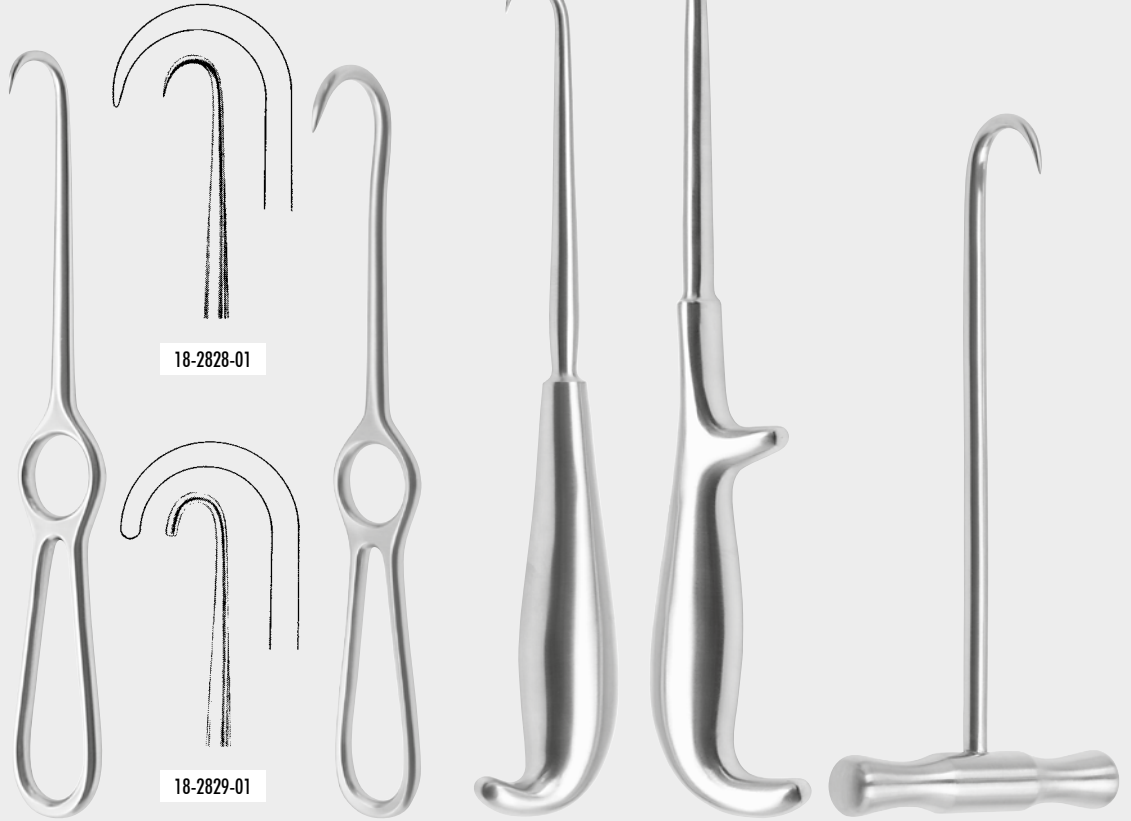

RETRACTORS

cm VOLKMANN
21,5 18-2828-01-18-2829-01

20,0 cm
18-2830-01
18-2831-01

mm 23,0 cm
9,5 18-2832-09
19,0 18-2832-19
25,0 18-2832-25

GINESTET 24,0 cm
18-2833-01

18,0 cm
18-2834-01

ÉCARTEURS

SEPARADORES

DIVARICATORI

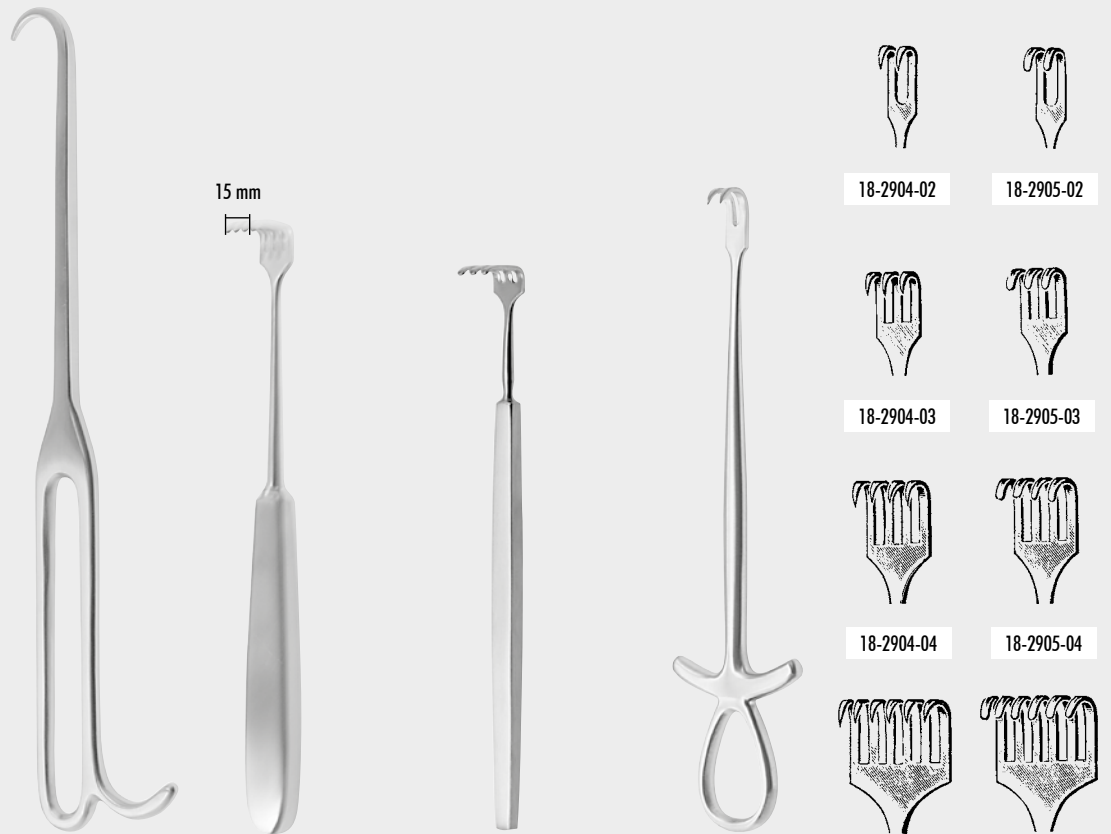

cm LAMBOTTE
22,0 18-2836-22
25,0 18-2836-25
28,0 18-2836-28

cm
15,0 18-2897-04
15 x 12 mm

mm PAUL 12,0 cm
11 x 8 18-2899-04

cm MURPHY
19,5 18-2904-02 - 18-2905-06

18-2904-06

18-2905-06



CAIRNS RAKE 22,0 cm
18-2906-03



CAIRNS RAKE 22,0 cm
18-2906-04



18-2991-02
12 x 6 mm



18-2991-03
12 x 11 mm

KLAPP
18-2991-02 - 18-2991-03



KRASKY 28,0 cm
18-2992-06

WUNDHAKEN
WUNDSPERRER

RETRACTORS

ÉCARTEURS

SEPARADORES

DIVARICATORI



18 x 7 mm 18-3002-01



16 x 5 mm 18-3002-02



7 x 4 mm 18-3002-03



7 x 4 mm 18-3002-04



10 x 3 mm 18-3002-05



10 x 4 mm 18-3002-06



cm MEYERDING
18,0 18-3002-01- 18-3002-06

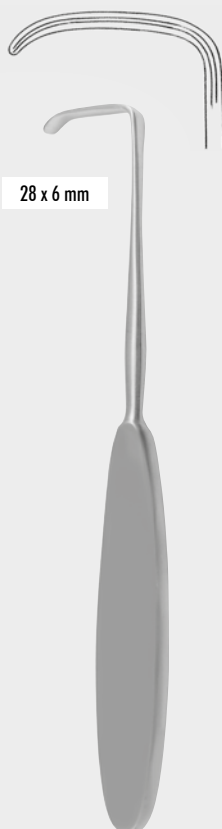

28 x 6 mm

cm LAHEY
19,0 18-3004-19



12 x 14 mm

cm LITTLE
20,0 18-3006-20



cm LANGENBECK
22,0 18-3100-01 - 18-3100-05



cm LANGENBECK
21,0 18-3102-01 - 18-3102-07

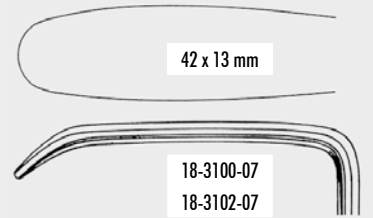
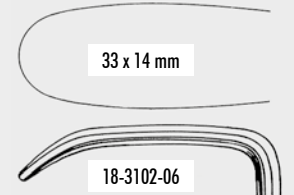
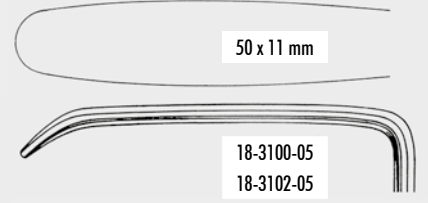
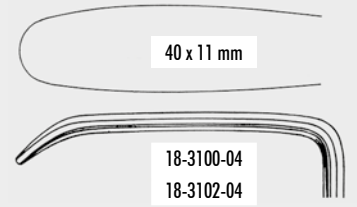
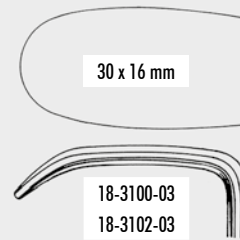
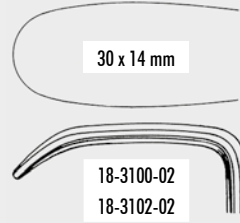
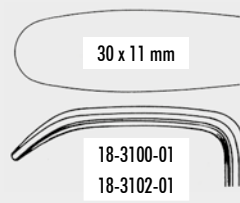

WUNDHAKEN
WUNDSPERRER

RETRACTORS

ÉCARTEURS

SEPARADORES

DIVARICATORI

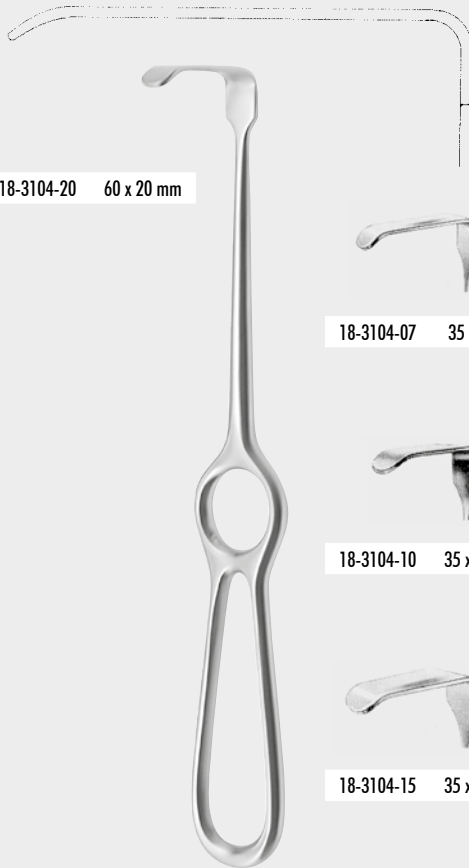

18-3104-20 60 x 20 mm



18-3104-07 35 x 7 mm



18-3104-10 35 x 10 mm



18-3104-15 35 x 15 mm

cm LANGENBECK
21,0 18-3104-07 - 18-3104-20



mm LANGENBECK
60 x 20 18-3105-21
55 x 20 18-3105-22



18-3100-01

18.20



mm LANGE 21,0 cm
40 x 10 18-3106-10



85 x 15 mm

cm LANGENBECK
21,0 18-3107-21

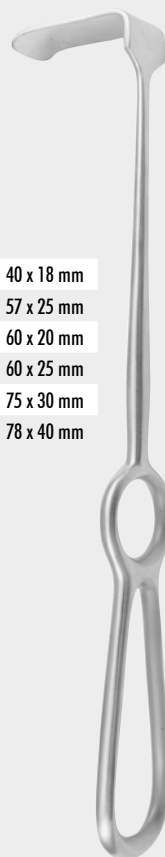

- 18-3108-40 40 x 18 mm
- 18-3108-57 57 x 25 mm
- 18-3108-60 60 x 20 mm
- 18-3108-61 60 x 25 mm
- 18-3108-75 75 x 30 mm
- 18-3108-78 78 x 40 mm

cm KOCHER
23,0 18-3108-40 - 18-3108-78

WUNDHAKEN
WUNDSPERRER

RETRACTORS

ÉCARTEURS

SEPARADORES

DIVARICATORI



mm KOCHER 21,0 cm
23 x 8 18-3110-23



mm KOCHER 23,0 cm
40 x 18 18-3120-18
60 x 20 18-3120-20
60 x 25 18-3120-25
75 x 30 18-3120-30
75 x 40 18-3120-40

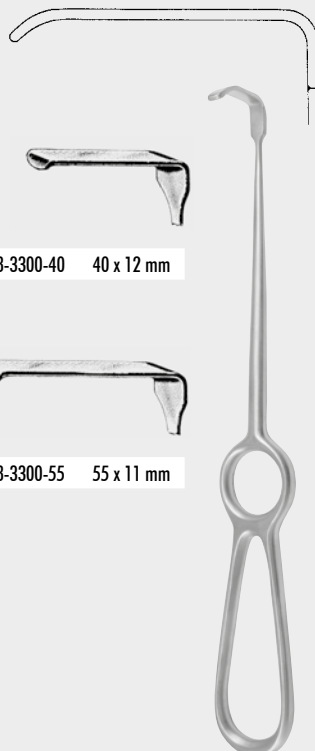

18-3300-40 40 x 12 mm

18-3300-55 55 x 11 mm

cm KOCHER
19,0 18-3300-40 - 18-3300-55

WUNDHAKEN
WUNDSPERRER

RETRACTORS



mm BROMHEAD
70 x 22 18-3301-22



cm KOCHER
19,0 18-3302-19 - 18-3302-21



18-3302-19 19 x 12 mm



18-3302-21 21 x 14 mm

ÉCARTEURS

SEPARADORES

DIVARICATORI



mm KOCHER 22,0 cm
40 x 10 18-3400-10
40 x 15 18-3400-15
40 x 20 18-3400-20

10 x 10 mm



cm CUSHING KOCHER
18,0 18-3401-18



mm LONDON HOSPITAL
32 x 19 18-3401-19
23,0 cm

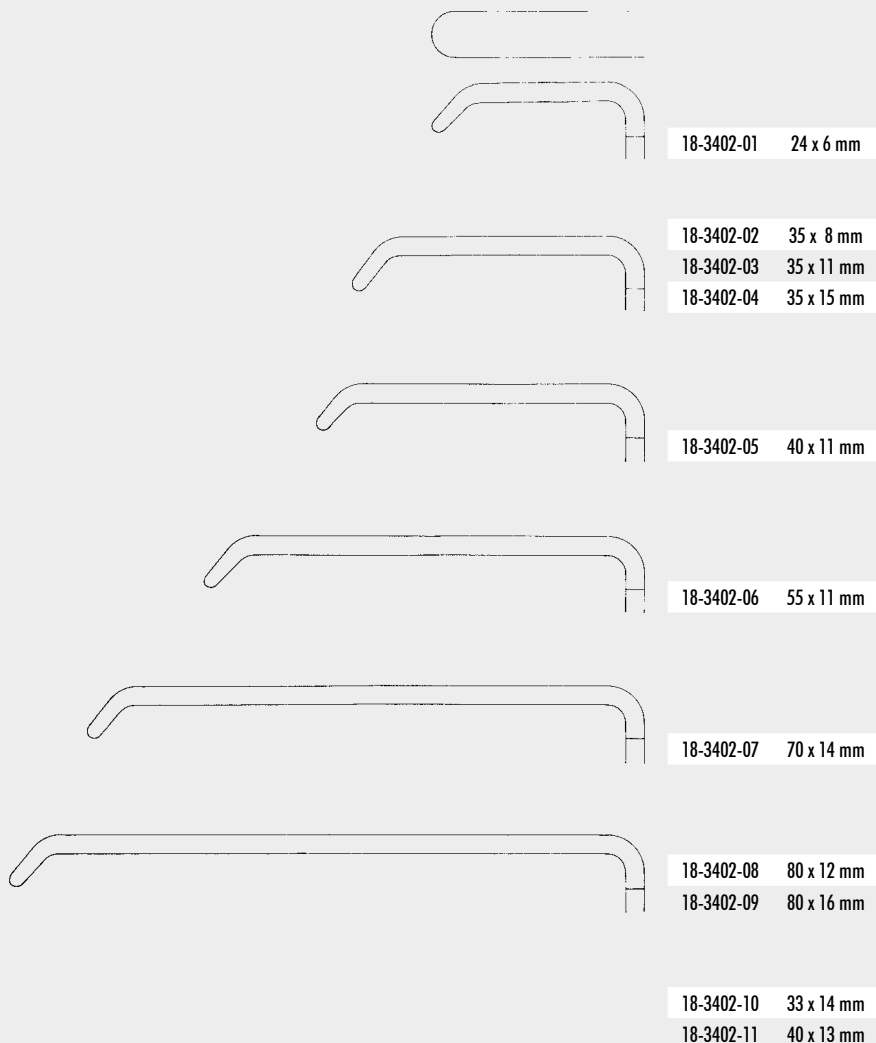

cm KOCHER LANGENBECK
21,5 18-3402-01 - 18-3402-09

WUNDHAKEN
WUNDSPERRER

RETRACTORS

ÉCARTEURS

SEPARADORES

DIVARICATORI



cm 18,0 18-3403-01



cm 18,0 18-3403-02



cm 18,0 18-3403-03



18-3404-14 14 x 17 mm



18-3404-20 20 x 22 mm



18-3404-26 26 x 30 mm



cm GREEN
22,0 18-3408-22



mm OLLIER 22,5 cm
36 x 25 18-3600-02
36 x 30 18-3600-03
36 x 60 18-3600-04

WUNDHAKEN
WUNDSPERRER

RETRACTORS

cm MIDDELDORPF
23,5 18-3404-14 - 18-3404-26

ÉCARTEURS

SEPARADORES

DIVARICATORI

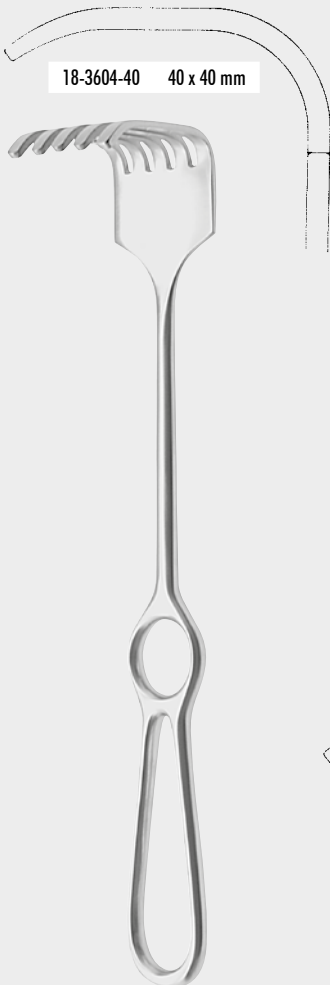

18-3604-40 40 x 40 mm



18-3604-50 45 x 50 mm

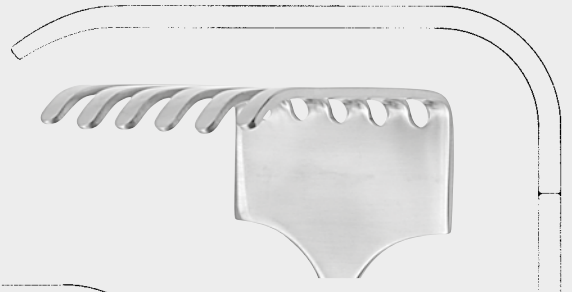

18-3604-70 70 x 70 mm

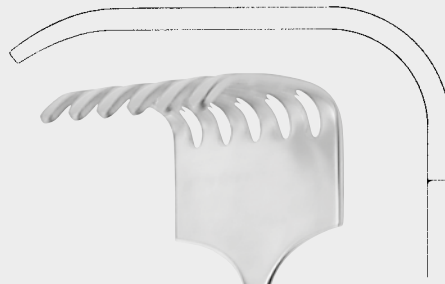

18-3604-60 50 x 60 mm

cm ISRAEL
25,0 18-3604-40 - 18-3604-70



18-3404-14

18.24



cm	mm	KOERTE
23,5	40 x 30	18-3606-08 18-3607-08

cm	mm	KOERTE
23,0	46 x 55	18-3609-04

FRITSCH	mm	cm
18-3700-31	37 x 31	23,5
18-3700-35	35 x 40	24,0
18-3700-40	45 x 40	24,0
18-3700-41	38 x 40	24,0
18-3700-50	45 x 50	24,0
18-3700-51	43 x 51	25,0
18-3700-60	45 x 60	24,0
18-3700-61	49 x 61	25,0
18-3700-75	55 x 75	24,0
18-3700-76	48 x 75	25,5
18-3700-85	65 x 85	26,5

WUNDHAKEN
WUNDSPERRER

RETRACTORS

ÉCARTEURS

SEPARADORES

DIVARICATORI



cm	mm	KOCHER
22,5	70 x 25	18-3702-22

mm	KOCHER 25,0 cm
80 x 45	18-3704-45
80 x 55	18-3704-55
80 x 65	18-3704-65

mm	HOESEL 25,0 cm
60 x 20	18-3706-01
80 x 30	18-3706-02
100 x 30	18-3706-03
120 x 30	18-3706-04
140 x 30	18-3706-05
140 x 40	18-3706-06
220 x 40	18-3706-07

ZEPF®
INSTRUMENTS

18-3706-07

18.25



WUNDHAKEN
WUNDSPERRER

RETRACTORS

ÉCARTEURS

SEPARADORES

DIVARICATORI



18-3800-35
95 x 35 mm

90 x 50 mm 18-3802-50
85 x 55 mm 18-3802-55

120 x 50 mm 18-3800-50
85 x 35 mm 18-3801-35
150 x 50 mm 18-3801-50
180 x 50 mm 18-3801-51

mm	KELLY 27,0 cm
160 x 38	18-3805-38
160 x 57	18-3805-57

cm	mm	DOYEN
25,0	50 x 85	18-3708-25
26,0	78 x 82	18-3709-26

cm	MIKULICZ
26,0	18-3800-35 - 18-3802-55



cm	FOSS
26,0	18-3810-55



cm	FOSS
18,0	18-3810-75



18-3708-25

18.26

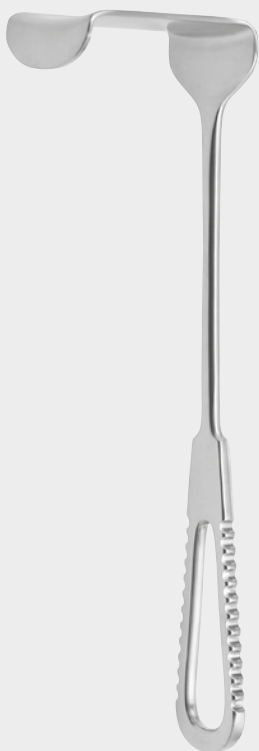

mm x mm	MORRIS 24,5 cm
70 x 40	18-3898-40
70 x 50	18-3898-50
70 x 65	18-3898-65

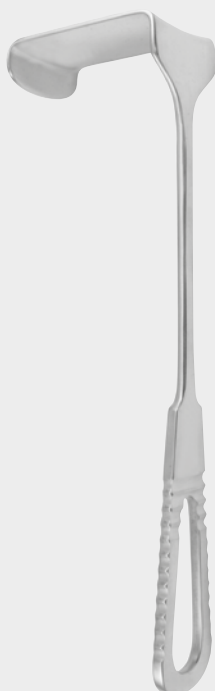

mm	MORRIS 21,0 cm
38 x 51	18-3900-38
51 x 51	18-3900-51
64 x 51	18-3900-64



mm	MORRIS 24,0 cm
32 x 51/38 x 51	18-3902-01
44 x 51/51 x 51	18-3902-02
64 x 51/38 x 51	18-3902-03

WUNDHAKEN
WUNDSPERRER

RETRACTORS

ÉCARTEURS

SEPARADORES

DIVARICATORI



mm x mm	KRÄMER 21,0 cm
60 x 10	18-3904-10



cm	MARTIN
26,0	18-4798-26
110 x 27 mm	

WUNDHAKEN
WUNDSPERRER

RETRACTORS

ÉCARTEURS

SEPARADORES

DIVARICATORI

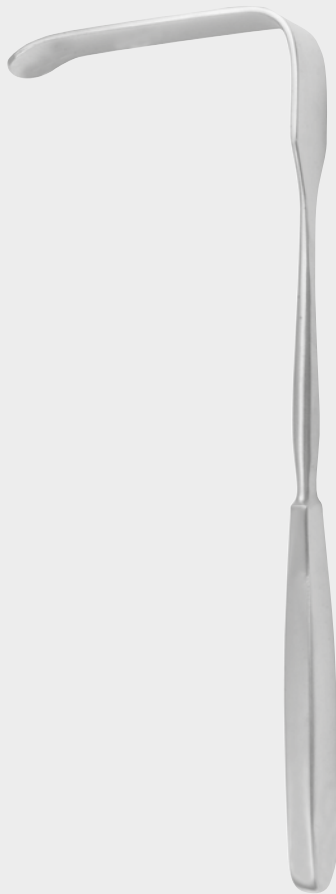

mm	SIMON 28,0 cm
115 x 22	18-4800-22
115 x 27	18-4800-27



mm	HEANEY 28,0 cm
45 x 28	18-4802-45
73 x 28	18-4802-73
82 x 28	18-4802-82



mm	HEANEY 16,0 cm
44 x 25	18-4803-44



mm	HEANEY SIMON 27,5 cm
25 x 115	18-4804-25



cm	ST. MARKS LLOYD-DAVIES	
29,0	18-4810-29	130 x 60 / 35 x 45 mm
32,0	18-4810-32	175 x 60 / 60 x 45 mm
33,0	18-4810-33	180 x 60 / 65 x 45 mm



Kaltlicht Anschluß
Fiber light connection

mm	ST. MARKS LLOYD DAVIES	
180 x 60/60 x 45	18-4811-32	32,0 cm

WUNDHAKEN
WUNDSPERRER

RETRACTORS

ÉCARTEURS

SEPARADORES

DIVARICATORI



mm KOERTE 28,0 cm
120 x 47 18-4815-28

mm	LERICHE	cm
45	18-4817-25	31,0
60	18-4817-27	33,0

mm KUEMMEL 28,0 cm
100 x 45 18-4821-28

ZEPF[®]
α
INSTRUMENTS

18-4821-28

18.29



125 x 37 mm



cm SAUERBRUCH
25,0 18-4898-25

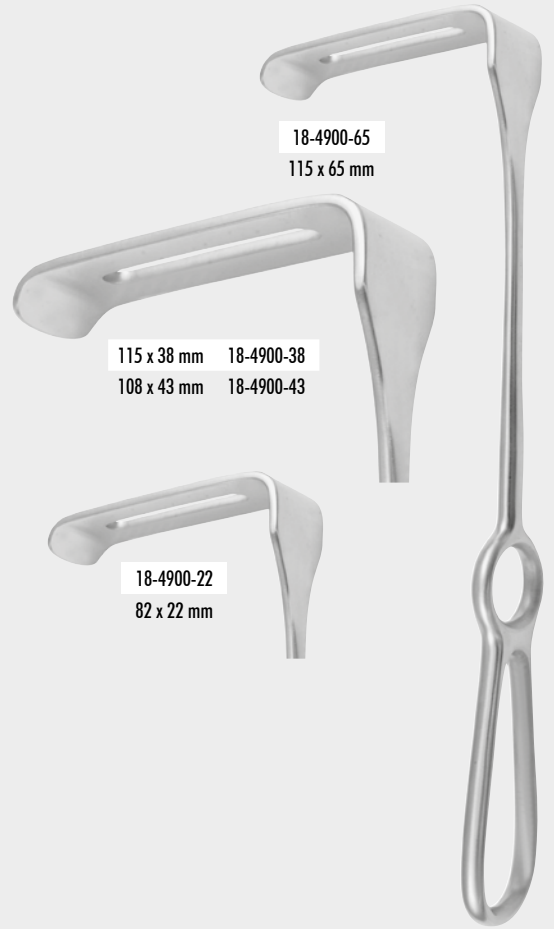

18-4900-65
115 x 65 mm

115 x 38 mm 18-4900-38
108 x 43 mm 18-4900-43

18-4900-22
82 x 22 mm

cm CORYLLOS (Thorax)
24,0 18-4900-22 - 18-4900-65

WUNDHAKEN
WUNDSPERRER

RETRACTORS

mm	KADER 27,0 cm
20	18-4823-20
30	18-4823-30
40	18-4823-40

ÉCARTEURS

SEPARADORES

DIVARICATORI

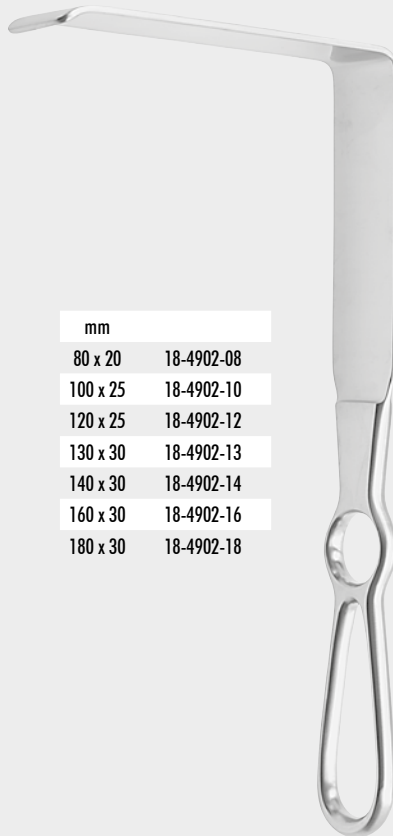

mm	
80 x 20	18-4902-08
100 x 25	18-4902-10
120 x 25	18-4902-12
130 x 30	18-4902-13
140 x 30	18-4902-14
160 x 30	18-4902-16
180 x 30	18-4902-18

cm BRUNNER
25,0 18-4902-08 - 18-4902-18

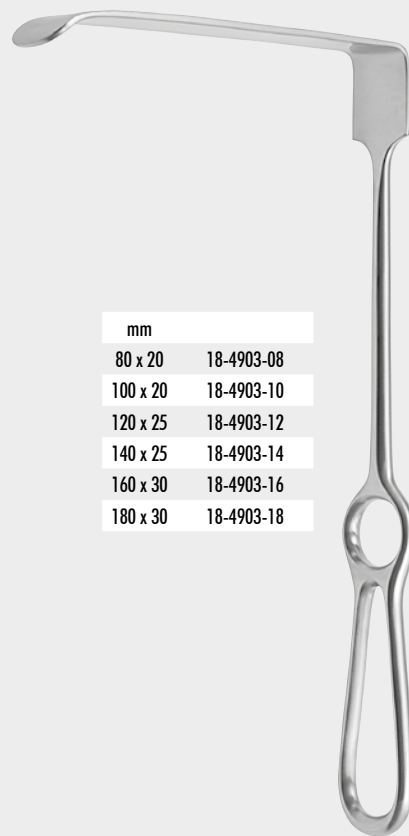

mm	
80 x 20	18-4903-08
100 x 20	18-4903-10
120 x 25	18-4903-12
140 x 25	18-4903-14
160 x 30	18-4903-16
180 x 30	18-4903-18

cm BRUNNER
25,0 18-4903-08 - 18-4903-18



18-4823-20

18.30

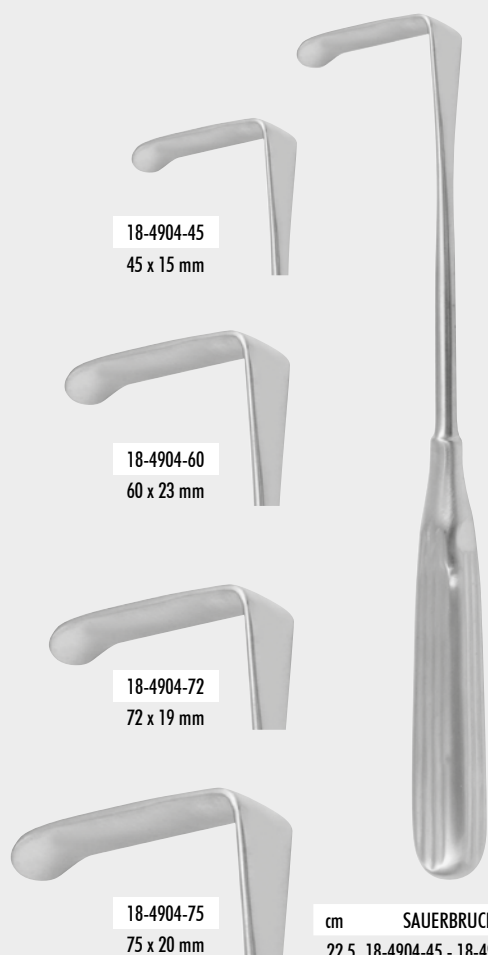

18-4904-45
45 x 15 mm

18-4904-60
60 x 23 mm

18-4904-72
72 x 19 mm

18-4904-75
75 x 20 mm

cm SAUERBRUCH
22,5 18-4904-45 - 18-4904-75

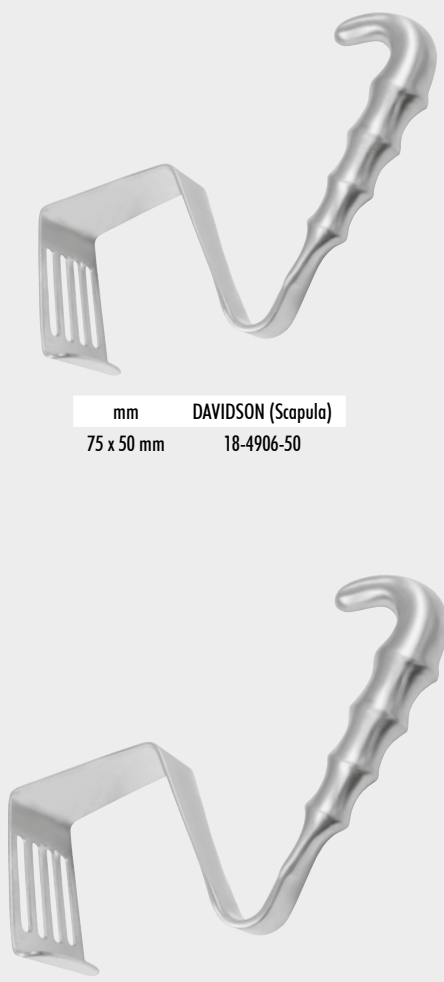

mm DAVIDSON (Scapula)
75 x 50 mm 18-4906-50

mm DAVIDSON (Scapula)
75 x 90 mm 18-4906-90

WUNDHAKEN
WUNDSPERRER

RETRACTORS

ÉCARTEURS

SEPARADORES

DIVARICATORI



cm	mm	MEYERDING
20,0	50 x 16	18-4908-01
22,0	75 x 25	18-4908-02
24,0	90 x 50	18-4908-03



cm	mm	ZENKER
18,0	10 x 3	18-4912-10
25,0	35 x 8	18-4912-35
26,0	60 x 12	18-4912-60
27,5	75 x 12	18-4912-75
26,5	85 x 20	18-4912-85
30,5	100 x 25	18-4913-10



18-4913-20

18.31

WUNDHAKEN
WUNDSPERRER



cm	DOYEN STILLE	mm
24,0	18-4921-20	90 x 28
24,0	18-4921-21	105 x 30
24,0	18-4921-22	120 x 52



mm	TUDOR EDWARDS 20,5 cm
55 x 47	18-4923-20



mm	TUFFIER 23,0 cm
64 x 60	18-4925-23

RETRACTORS

ÉCARTEURS

SEPARADORES

DIVARICATORI



mm	41,0 cm
245 x 30	18-4930-30
245 x 40	18-4930-40
245 x 50	18-4930-50
245 x 60	18-4930-60
245 x 70	18-4930-70



mm	MIDDELDORPF 25,5 cm
45 x 45	18-4933-45
45 x 50	18-4933-50
55 x 70	18-4933-70



mm	DURHAM 21,5 cm
10 x 19	18-4937-19
16 x 25	18-4937-25
22 x 38	18-4937-38



cm	mm	CANNY RYALL
19,0	16 x 25	18-4941-35
19,0	19 x 28	18-4941-60
20,5	25 x 32	18-4941-75



18-4921-20

18.32



cm POLLOSON
27,0 18-4951-25

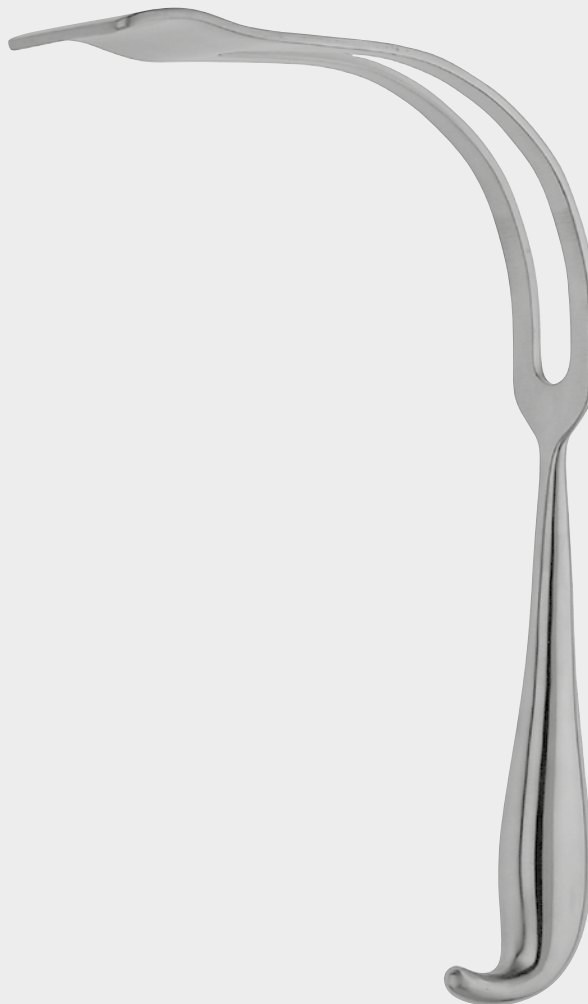

cm POLLOSON
27,0 18-4953-27

WUNDHAKEN
WUNDSPERRER

RETRACTORS

ÉCARTEURS

SEPARADORES

DIVARICATORI



cm BÜCHS
20,5 18-4961-20

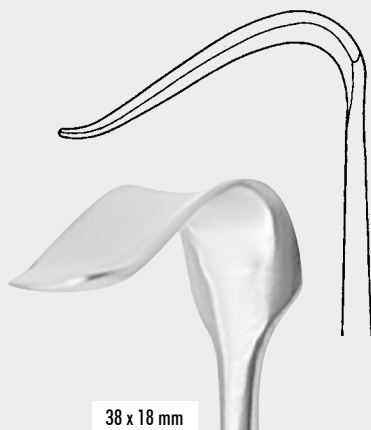

38 x 18 mm



cm WASSMUND
20,0 18-4965-20

ZEPF®
α
INSTRUMENTS

18-4965-20

18.33



Handchirurgie
Hand Surgery
Chirurgie de la main
Cirugía de la mano
Chirurgia della mano

WUNDHAKEN
WUNDSPERRER

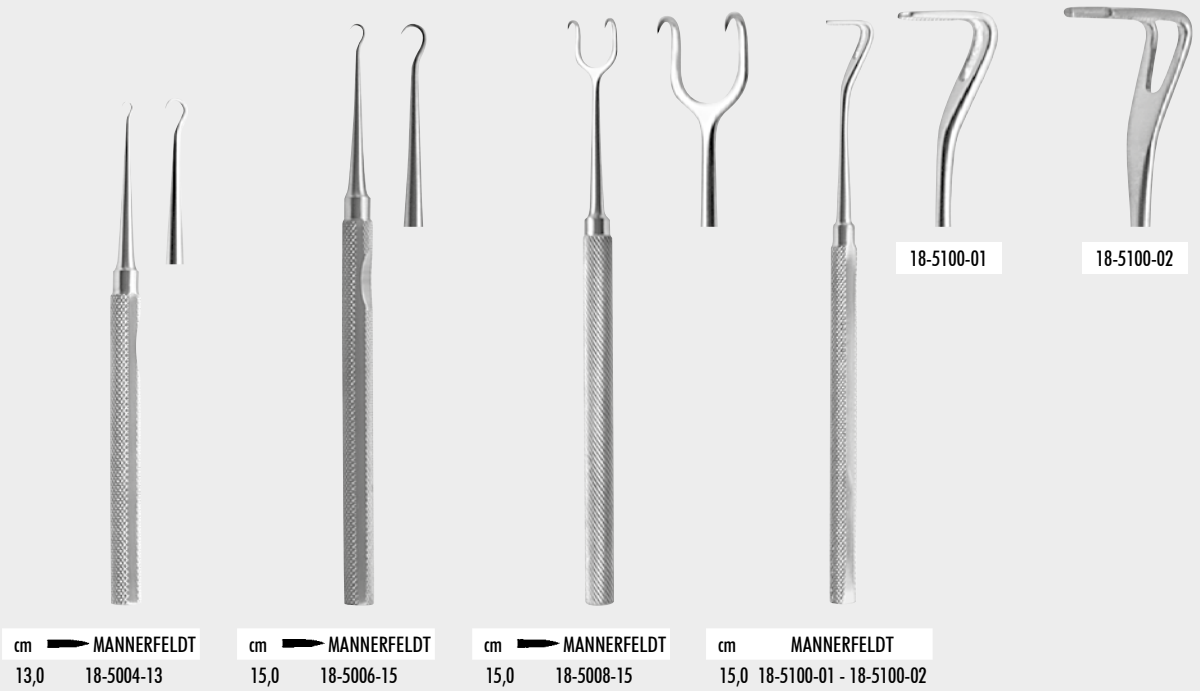

RETRACTORS

ÉCARTEURS

SEPARADORES

DIVARICATORI

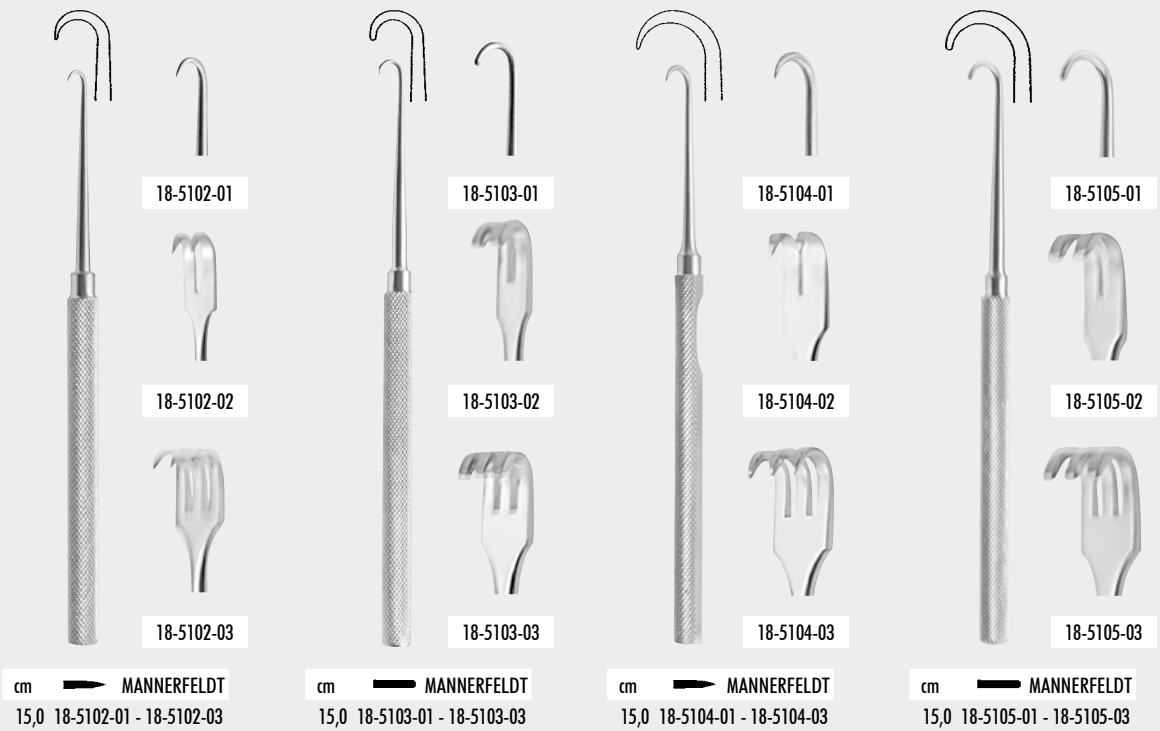

18-5004-13

18.34

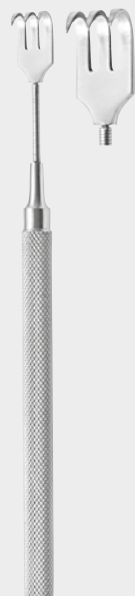

cm  MANNERFELDT
15,0 18-5106-03



cm mm MANNERFELDT
15,0 16 x 6 18-5107-15



cm LANGENBECK MANNERFELDT
15,0 18-5108-15 - 18-5108-30



15 x 6 mm 18-5108-15



20 x 6 mm 18-5108-20



25 x 6 mm 18-5108-25



30 x 6 mm 18-5108-30

Handchirurgie
Hand Surgery
Chirurgie de la main
Cirugía de la mano
Chirurgia della mano

WUNDHAKEN
WUNDSPERRER

RETRACTORS

ÉCARTEURS

SEPARADORES

DIVARICATORI



12 x 12 mm 18-5109-12



cm MANNERFELDT
15,0 18-5109-12 - 18-5109-16



12 x 14 mm 18-5109-14



14 x 16 mm 18-5109-16



cm mm MANNERFELDT
15,0 12 x 12 18-5200-15



cm MANNERFELDT
15,0 18-5201-16



cm MANNERFELDT
15,0 18-5202-16



18-5202-16

18.35

WUNDHAKEN
WUNDSPERRER

RETRACTORS

ÉCARTEURS

SEPARADORES

DIVARICATORI



cm BERGMANN
14,0 18-5220-14



mm
13 x 13 18-5224-13

mm
13 x 16 18-5224-16

cm KÖNIG
17,0 18-5224-13 - 18-5224-16

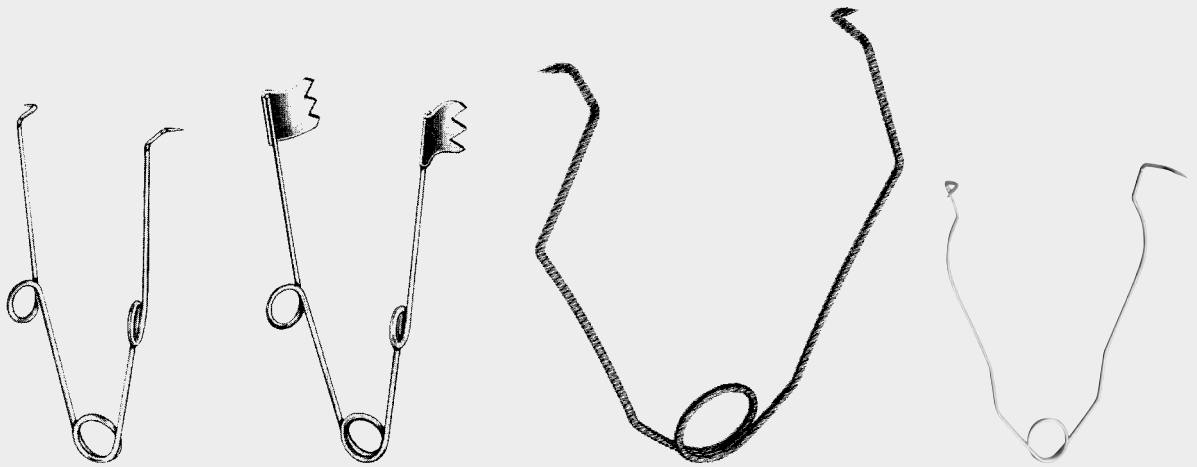

cm
7,5 18-6002-07
11,5 18-6002-11

cm
8,5 18-6003-08
11,5 18-6003-11

cm mm FARR
14,0 19 18-6006-01
14,0 32 18-6006-02
23,0 33 18-6006-03

mm FARR
38 18-6008-38
50 18-6008-50
57 18-6008-57
64 18-6008-64
75 18-6008-75



18-5220-14

18.36



cm	FINSEN
5,0	18-6090-05 18-6091-05



cm	FINSEN modif.
7,0	18-6094-07 18-6095-07

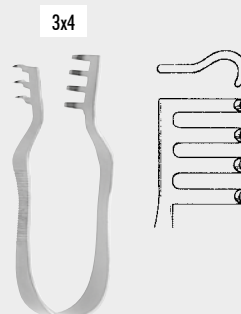

cm	FINSEN
5,0	18-6100-05 18-6101-05
7,0	18-6100-07 18-6101-07

WUNDHAKEN
WUNDSPERRER

RETRACTORS

ÉCARTEURS

SEPARADORES

DIVARICATORI

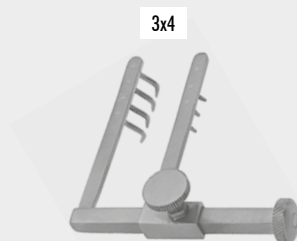

cm	LOGAN
4,0	18-6102-04

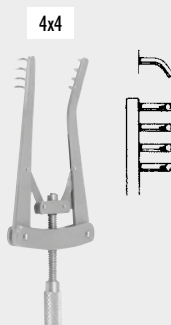

cm	ALM
7,0	18-6200-07 18-6201-07
10,0	18-6200-10 18-6201-10 *18-6203-10

* halb scharf
semi sharp
demi mousse
semi agudo
semi acuto



18-6203-10

18.37

WUNDHAKEN
WUNDSPERRER



cm ALLPORT
10,0 18-6204-10



cm JANSEN GIFFORD
10,0 18-6208-10 18-6209-10

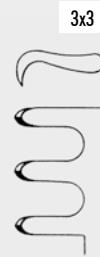

cm JANSEN
10,0 18-6300-10

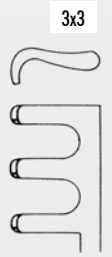

cm JANSEN
10,0 18-6301-10

RETRACTORS

ÉCARTEURS

SEPARADORES

DIVARICATORI



cm WAGNER-JANSEN
10,0 18-6302-11

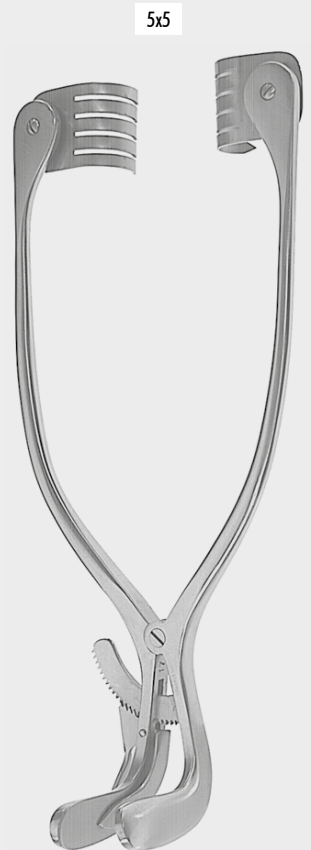

cm JACKSON
19,0 18-6324-19
Kropf
Goitre
Bocio
Gozzo



cm HEISS
10,0 18-6304-10 18-6305-10



cm SNITMAN
10,5 18-6310-10 18-6311-10



cm KOCHER
16,0 18-6400-16

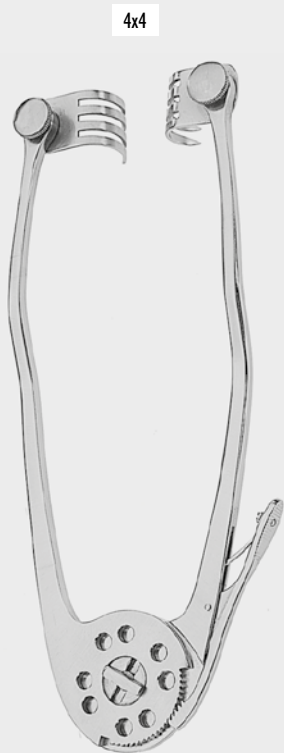

cm CROTTI
18,0 18-6402-18

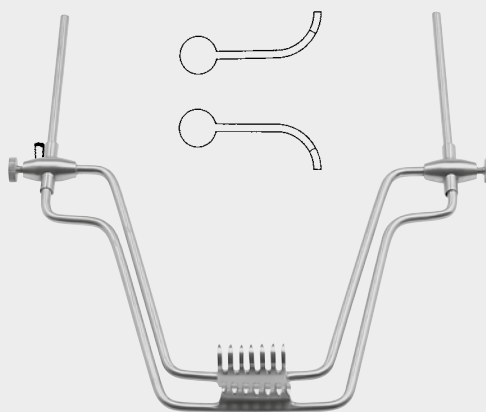

STRUMA
18-6407-00

Kropfsperrer
Goitre Retractors
Écarteurs à goitre
Separadores para bocio
Divaricatori per gozzo

WUNDHAKEN
WUNDSPERRER

RETRACTORS

ÉCARTEURS

SEPARADORES

DIVARICATORI

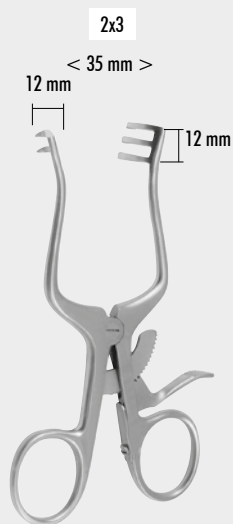

cm WEITLANER
11,5 18-6500-10 18-6501-10

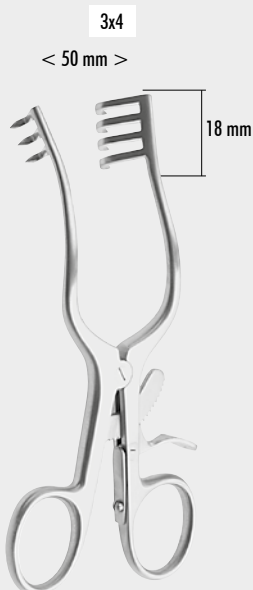

cm WEITLANER-WULLSTEIN
13,0 *18-6503-10 18-6504-13 18-6505-13

* halb scharf
semi sharp
demi mousse
semi agudo
semi acuto



cm « PLESTER
11,0 18-6507-11



cm » PLESTER
11,0 18-6509-11

ZEPF®
INSTRUMENTS

18-6509-11

18.39

2x2



cm PLESTER
13,0 18-6510-13 18-6511-13

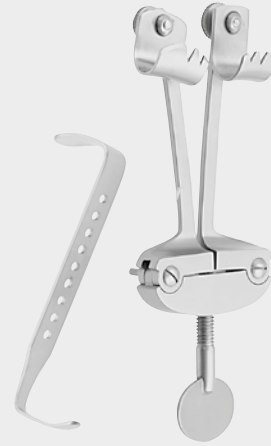

cm HENNER (LEMPERT)
12,0 18-6512-12

WUNDHAKEN
WUNDSPERRER

RETRACTORS

ÉCARTEURS

SEPARADORES

DIVARICATORI

2x2

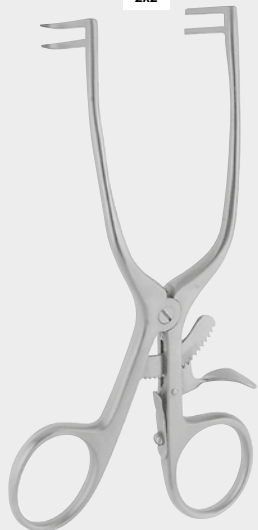

cm MOLLISON
13,0 18-6518-13

2x2



cm SCHUKNECHT
14,0 18-6600-14

3x3



cm MILLIGAN
13,0 18-6680-13

ZEPF[®]
α
INSTRUMENTS

18-6510-13

18.40



cm **WEITLANER**
13,0 18-6690-13 18-6691-13

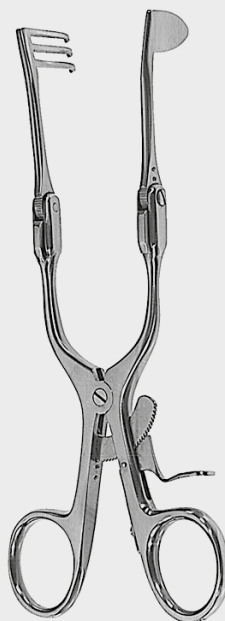

cm « **BECKMANN FISH** »
16,5 18-6602-16 18-6603-16

WUNDHAKEN
WUNDSPERRER

RETRACTORS

ÉCARTEURS

SEPARADORES



cm **WEITLANER BABY**
13,0 18-6686-13

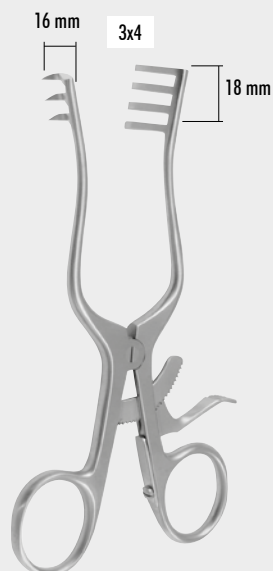

* halb scharf
semi sharp
demi mousse
semi agudo
semi acuto

cm	WEITLANER	
13,0	*18-6698-13	
14,0	18-6700-14	18-6701-14
16,5	*18-6698-16	18-6700-16 18-6701-16
20,0	18-6700-20	18-6701-20
24,0	18-6700-24	18-6701-24

DIVARICATORI

ZEPF[®]
α
INSTRUMENTS

18-6701-24

18.41



WUNDHAKEN
WUNDSPERRER

RETRACTORS

ÉCARTEURS

SEPARADORES

DIVARICATORI



18-6700-25

18.42

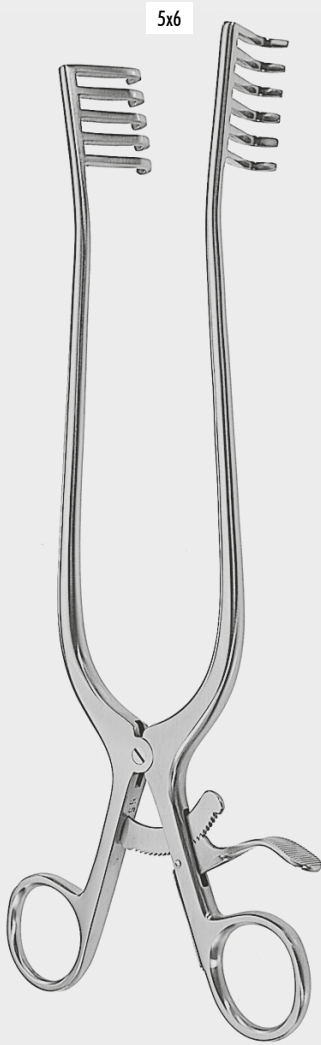

5x6

cm	WEITLANER	
25,0	18-6700-25	18-6701-25
26,0	18-6700-26	18-6701-26

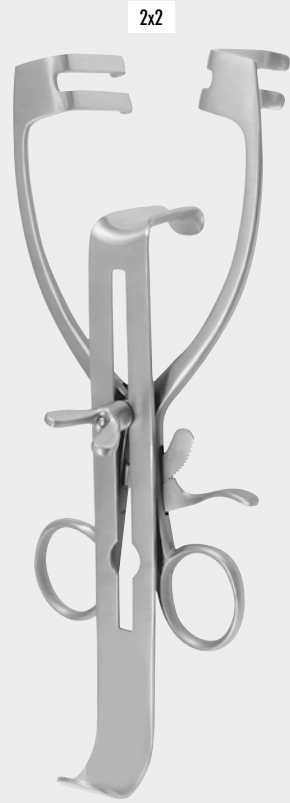

2x2

cm	MAYO ADAMS
17,0	18-6702-17
17,0	18-6702-18

mit Mittelblatt
with central blade
avec valve centrale
con valva central
con valva centrale



3x4

cm	CONTOUR SCALP	
14,0	18-6702-14	18-6703-14



cm	TÜBINGEN
16,5	18-6705-16



7x7

cm	MISKIMON CEREBELLUM
22,0	18-6706-22



cm ANDERSON ADSON
20,0 18-6708-20 18-6709-20

Für Laminektomie - for Laminectomy - pour laminectomie
para laminectomía - per laminectomia



cm WANE
25,5 18-6709-25

WUNDHAKEN
WUNDSPERRER

RETRACTORS

ÉCARTEURS

SEPARADORES

DIVARICATORI

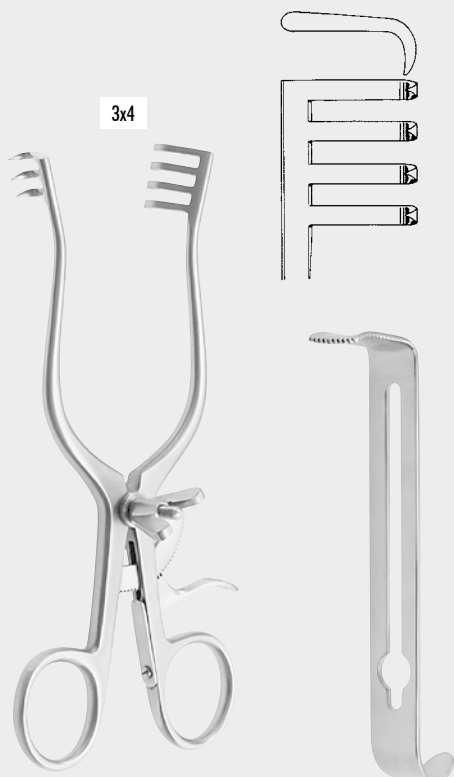

cm HENLY
16,5 18-6712-16 18-6713-16

mm
16 x 19 18-6714-19

mm
16 x 25 18-6714-25

mm
16 x 32 18-6714-32

Sperrer allein ohne Mittelblatt
Spreader only, without Centre Blade
Écarteur seul, sans valve centrale
Separador suelto, sin valva central
Divaricatore solo, senza valva centrale

Mittelblatt allein - Centre Blade only - Valve centrale seule -
Valva central suelta - Valva centrale sola



18-6714-32

18.43

WUNDHAKEN
WUNDSPERRER



cm JACKSON BURROWS
18,5 18-6717-18



cm RNTNE HOSPITAL
16,5 18-6790-16

Für Knieweichteile - for Knee Soft Parts - pour parties molles du genou
- para partes blandos de la rodilla - per parti molli del ginocchio

RETRACTORS

ÉCARTEURS

SEPARADORES

DIVARICATORI



cm HENDERSON
17,0 18-6792-17



cm IRWIN
17,0 18-6794-17



cm ADSON
19,0 18-6800-19 18-6801-19

Für Laminektomie - For Laminectomy - pour laminectomie -
para laminectomía - per laminectomia



cm	ADSON
26,5	18-6802-26 18-6803-26 3 x 4
27,0	18-6802-27 18-6803-27 5 x 6

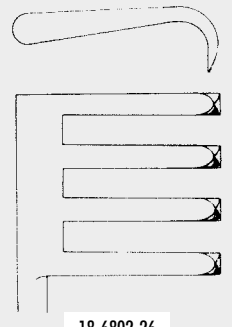

18-6802-26

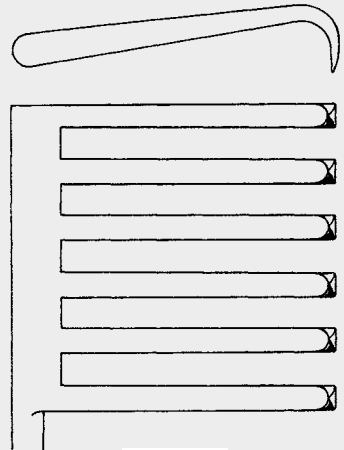

18-6802-27

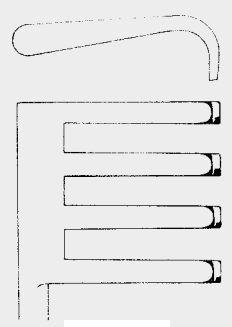

18-6803-26

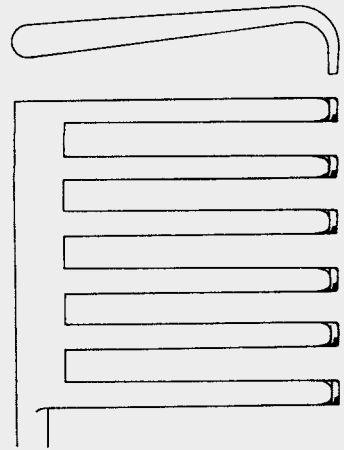

18-6803-27

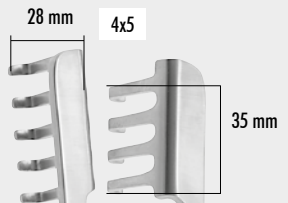

< 150 mm >

6x6



4x5

cm	TRAVERS
21,5	18-6804-21



cm	BECKMANN-ADSON
32,0	18-6805-32



cm	ADSON
27,0	18-6806-27 18-6807-27

Für Hemilaminectomie
 Hemilaminectomy
 Pour hémi laminectomie
 Para hemilaminectomía
 Per emilaminectomia

Laminectomie-Wundspreizer
 Laminectomy Spreaders
 Écarteurs pour laminectomie
 Separadores para laminectomía
 Divaricatori per laminectomia

WUNDHAKEN
 WUNDSPERRER

RETRACTORS

ÉCARTEURS

SEPARADORES

DIVARICATORI



18-6807-27

18.45



Hemilaminectomie-Wundspreizer
 Hemilaminectomy Spreaders
 Écarteurs pour hémilaminectomie
 Separadores para hemilaminectomía
 Divaricatori per emilaminectomia

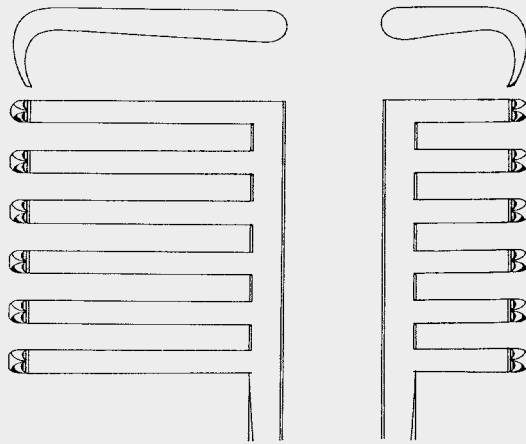

» 18-6808-27
 Kurzer Zahn 13 mm rechts
 Short tooth 13 mm right hand side
 Dent courte 13 mm à droite
 Diente corto 13 mm a la derecha
 Dente corto 13 mm a destra

WUNDHAKEN
 WUNDSPERRER

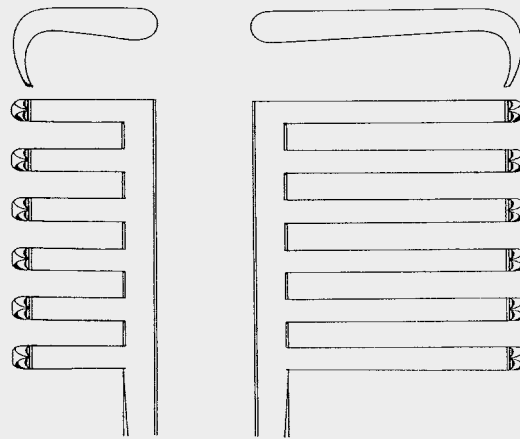

« 18-6809-27
 Kurzer Zahn 13 mm links
 Short tooth 13 mm left hand side
 Dent courte 13 mm à gauche
 Diente corto 13 mm a la izquierda
 Dente corto 13 mm a sinistra

RETRACTORS

ÉCARTEURS

SEPARADORES

DIVARICATORI



cm » «
 27,0 18-6808-27 18-6809-27



18-6808-27

18.46



4x1

cm	CONE
16,5	18-6880-16
25,5	18-6880-25



1x4

cm	CONE
16,5	18-6882-16
25,5	18-6882-25



3x3

cm	HARVEY JACKSON
28,0	18-6884-28

Laminektomie-Wundspreizer
Laminectomy Spreaders
Écarteurs pour laminectomie
Separadores para laminectomía
Divaricatori per laminectomia

WUNDHAKEN
WUNDSPERRER

RETRACTORS

ÉCARTEURS

SEPARADORES

DIVARICATORI



4x4

cm	BECKMANN ADSON
30,5	18-6886-01 - 18-6887-01 25 x 25 mm
30,5	18-6886-02 - 18-6887-02 45 x 25 mm



17 mm < 150 mm >

4x4

26 mm

cm	BECKMANN
31,0	18-6900-31 - 18-6901-31



47 mm

7x7

< 140 mm >

51 mm

cm	BECKMANN-EATON
32,0	18-6902-32



4x4

cm MOLLISON
15,0 18-6903-15

halb scharf
semi sharp
demi-mousse
semi agudo
semi acuto



3x4

cm ADSON BABY
14,0 18-6904-14



WUNDHAKEN
WUNDSPERRER

RETRACTORS

ÉCARTEURS

SEPARADORES

3x4	cm	▶	■	
18 x 13 mm	18 x 18 mm	13,0	18-6904-13	18-6905-13 CONE
18 x 13 mm	18 x 18 mm	16,0	18-6904-16	18-6905-16 CONE (ADSON Baby)
22 x 16 mm	21 x 22 mm	20,0	18-6904-20	18-6905-20 CONE (BECKMANN)
28 x 16 mm	28 x 22 mm	25,0	18-6904-25	18-6905-25 CONE

DIVARICATORI

Poplitea-Spreizer
Spreaders popliteal
Écarteurs poplités
Separadores para poplitea
Divaricatori popliteali

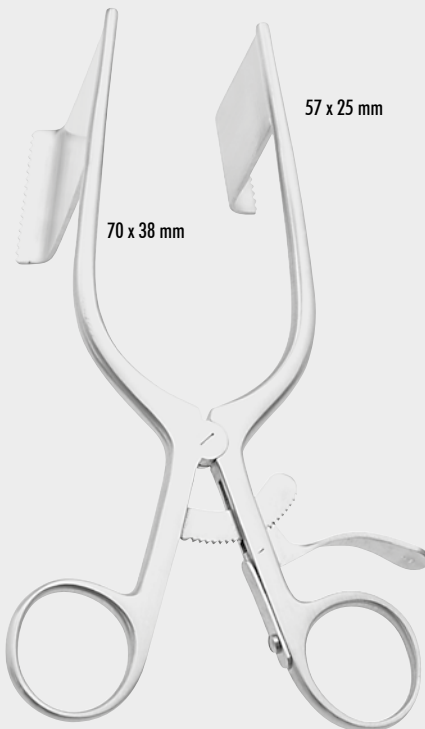

70 x 38 mm

57 x 25 mm

cm DARLING
18,0 18-6906-18

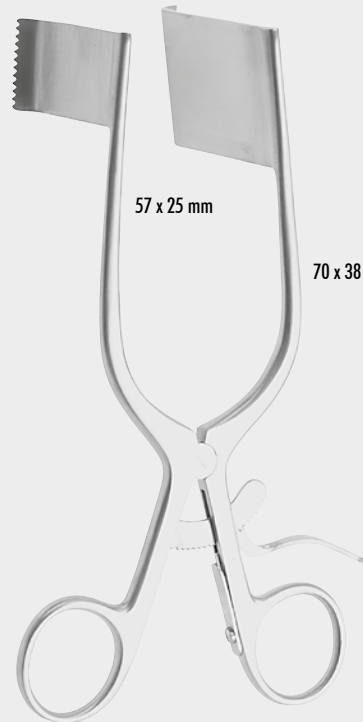

57 x 25 mm

70 x 38 mm

cm DARLING
18,0 18-6908-18



18-6903-15

18.48



5x5

cm NORTHFIELD
29,0 18-7002-29



cm CHARNLEY
28,0 18-7003-28

Horizontal-Spreizer
Horizontal Spreader
Écarteur horizontal
Separador horizontal
Divaricatore orizzontale

WUNDHAKEN
WUNDSPERRER

RETRACTORS

ÉCARTEURS

SEPARADORES

DIVARICATORI



7x1

cm » WALTON «
18,0 18-7007-01 18-7007-02

Für Hemilaminektomie - for Hemilaminectomy - pour hénilaminectomie
- para hemilaminectomía - per emilaminectomia



6x1

cm » KNIGHTON «
18,0 18-7008-01 18-7008-02

Für Laminektomie - for Laminectomy - pour laminectomie
para laminectomía - per laminectomia

Sperrer für die cervicale Wirbelsäule
 Retractor for Cervical Spine
 Écarteur pour la colonne cervicale
 Separador para la columna cervica
 Divaricatore per la colonna cervicale

WUNDHAKEN
 WUNDSPERRER

RETRACTORS

ÉCARTEURS

SEPARADORES

DIVARICATORI

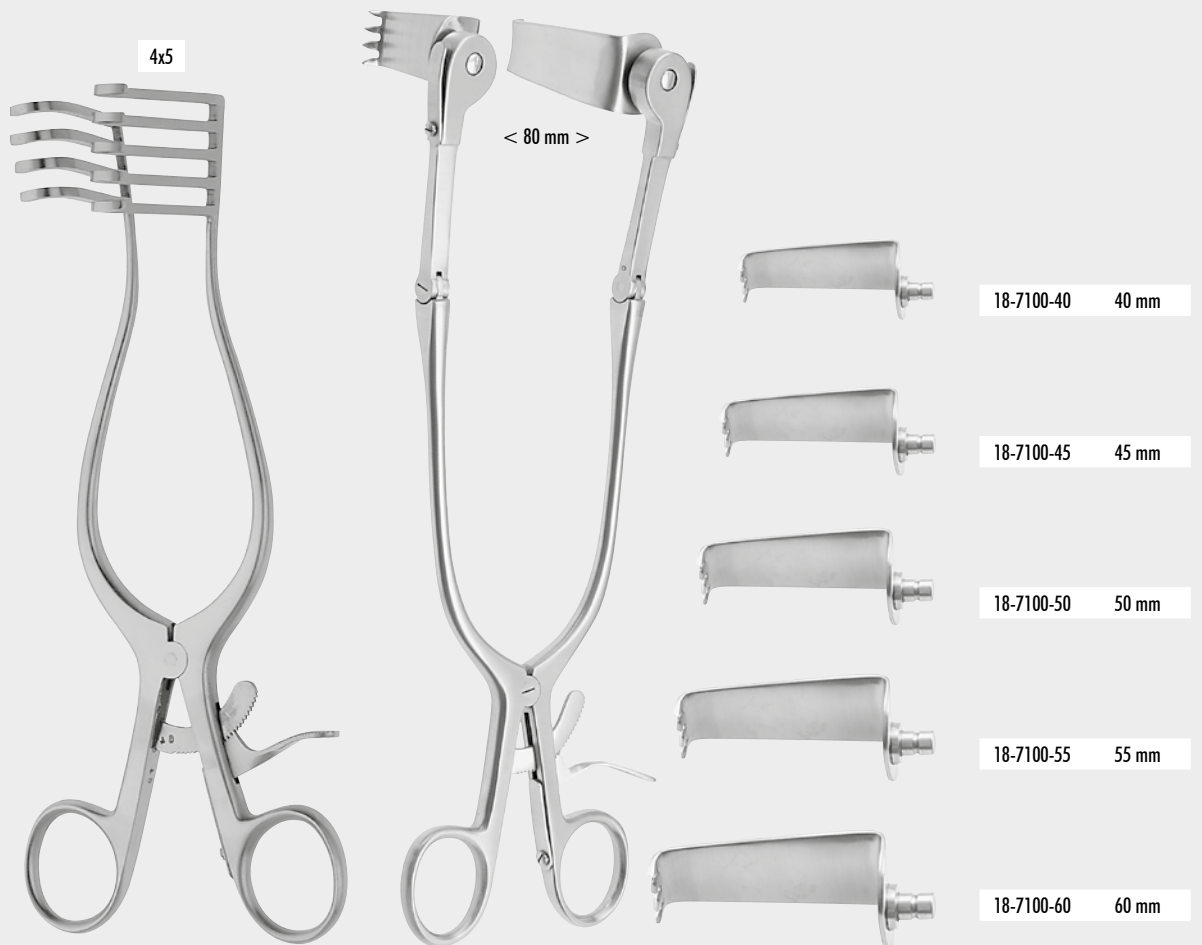

cm NORFOLK AND NORWICH
 22,0 18-7020-21

CLOWARD
 18-7100-00

komplett mit 5 Valven (18-7100-40, 18-7100-45 18-7100-50, 18-7100-55, 18-7100-60)
 Complete with 5 Blades (18-7100-40, 18-7100-45 18-7100-50, 18-7100-55, 18-7100-60)
 Complet avec 5 valves (18-7100-40, 18-7100-45 18-7100-50, 18-7100-55, 18-7100-60)
 Completo con 5 valvas (18-7100-40, 18-7100-45 18-7100-50, 18-7100-55, 18-7100-60)
 Completo di 5 valve (18-7100-40, 18-7100-45 18-7100-50, 18-7100-55, 18-7100-60)

CLOWARD
 18-7100-01

Sperrer allein ohne Valven
 Spreader only without blades
 Écarteur seul sans valves
 Separador suelto sin valvas
 Divaricatore solo senza valve

ZEPF[®]

 INSTRUMENTS

18-7020-21

18.50

Sperrer für die cervicale Wirbelsäule
 Retractor for Cervical Spine
 Écarteur pour la colonne cervicale
 Separador para la columna cervical
 Divaricatore per la colonna cervicale

WUNDHAKEN
 WUNDSPERRER

RETRACTORS

ÉCARTEURS

SEPARADORES

DIVARICATORI



CLOWARD
 18-7101-00

komplett mit 5 Valven (18-7101-40, 18-7101-45 18-7101-50, 18-7101-55, 18-7101-60)
 Complete with 5 Blades (18-7101-40, 18-7101-45 18-7101-50, 18-7101-55, 18-7101-60)
 Complet avec 5 valves (18-7101-40, 18-7101-45 18-7101-50, 18-7101-55, 18-7101-60)
 Completo con 5 valvas (18-7101-40, 18-7101-45 18-7101-50, 18-7101-55, 18-7101-60)
 Completo di 5 valve (18-7101-40, 18-7101-45 18-7101-50, 18-7101-55, 18-7101-60)

CLOWARD
 18-7101-01

Sperrer allein ohne Valven
 Spreader only without blades
 Écarteur seul sans valves
 Separador suelto sin valvas
 Divaricatore solo senza valve



18-7101-40 40 mm



18-7101-45 45 mm



18-7101-50 50 mm



18-7101-55 55 mm



18-7101-60 60 mm



18-7101-60

18.51



Titan
Titanium
Titane
Titanio

Hemilaminectomie-Sperrer
Hemilaminectomy Retractors
Écarteurs à hémilaminectomie
Separadores para hemilaminectomía
Divaricatori per emilaminectomia

WUNDHAKEN
WUNDSPERRER

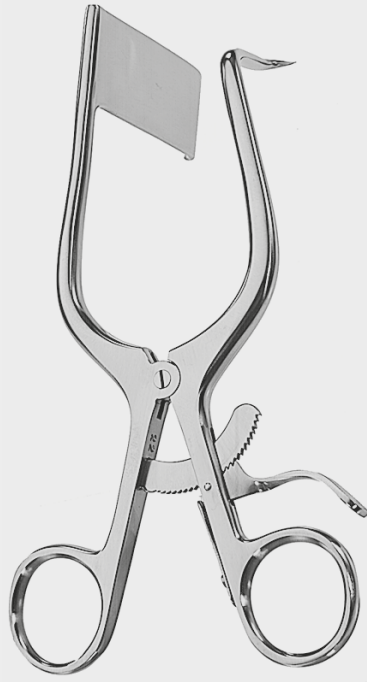

cm » MARKHAM MEYERDING «
18,0 18-7102-18 18-7103-18

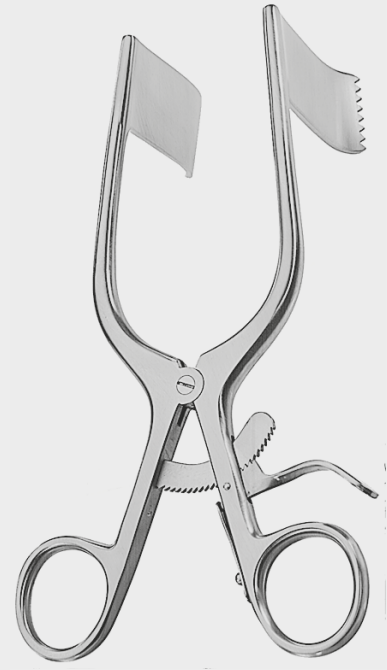

mm MEYERDING 18,0 cm
32 x 25 18-7104-32
54 x 25 18-7104-54
60 x 25 18-7104-60
60 x 19 18-7104-61

RETRACTORS

ÉCARTEURS

SEPARADORES

DIVARICATORI



CASPAR

18-7191-00 compl. 18-7191-15 / 18-7200-45 / 18-7200-50 / 18-7200-55 / 18-7200-60 / 18-7200-65
mit 5 Valven - with 5 blades - avec 5 valves - con 5 valvas - con 5 valve

18-7191-15 Gegensperrer allein - Counter-Retractor only - Contre-écarteur seul - Contra-separador suelto - Contra-divaricatore solo



	CASPAR
18-7200-40	40 x 23 mm
18-7200-45	45 x 23 mm
18-7200-50	50 x 23 mm
18-7200-55	55 x 23 mm
18-7200-60	60 x 23 mm
18-7200-65	65 x 23 mm
18-7200-75	72 x 23 mm

	CASPAR
18-7203-45	45 x 25 mm
18-7203-50	50 x 25 mm
18-7203-55	55 x 25 mm
18-7203-60	60 x 25 mm
18-7203-65	65 x 25 mm

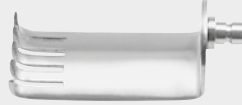

	CASPAR medial
18-7204-40	40 x 23 mm
18-7204-45	45 x 23 mm
18-7204-50	50 x 23 mm
18-7204-55	55 x 23 mm
18-7204-60	60 x 23 mm

	CASPAR medial
18-7207-40	40 x 25 mm
18-7207-45	45 x 25 mm
18-7207-50	50 x 25 mm
18-7207-55	55 x 25 mm
18-7207-60	60 x 25 mm



	CASPAR lateral
18-7205-40	40 x 23 mm
18-7205-45	45 x 23 mm
18-7205-50	50 x 23 mm
18-7205-55	55 x 23 mm
18-7205-60	60 x 23 mm

	CASPAR lateral
18-7208-40	40 x 25 mm
18-7208-45	45 x 25 mm
18-7208-50	50 x 25 mm
18-7208-55	55 x 25 mm
18-7208-60	60 x 25 mm



	CASPAR
18-7206-50	50 x 25 mm
18-7206-60	60 x 25 mm

	CASPAR
18-7209-50	50 x 25 mm
18-7209-60	60 x 25 mm



18-7102-18

18.52



CASPAR medial	
18-7204-40	40 x 23 mm
18-7204-45	45 x 23 mm
18-7204-50	50 x 23 mm
18-7204-55	55 x 23 mm
18-7204-60	60 x 23 mm



CASPAR lateral	
18-7205-40	40 x 23 mm
18-7205-45	45 x 23 mm
18-7205-50	50 x 23 mm
18-7205-55	55 x 23 mm
18-7205-60	60 x 23 mm

CASPAR medial	
18-7207-40	40 x 25 mm
18-7207-45	45 x 25 mm
18-7207-50	50 x 25 mm
18-7207-55	55 x 25 mm
18-7207-60	60 x 25 mm

CASPAR lateral	
18-7208-40	40 x 25 mm
18-7208-45	45 x 25 mm
18-7208-50	50 x 25 mm
18-7208-55	55 x 25 mm
18-7208-60	60 x 25 mm

Wundspreizer für die cervicale Wirbelsäule
Retractors for Cervical Spine
Écarteurs pour la colonne cervicale
Separadores para la columna cervical
Divaricatori per la colonna cervicale

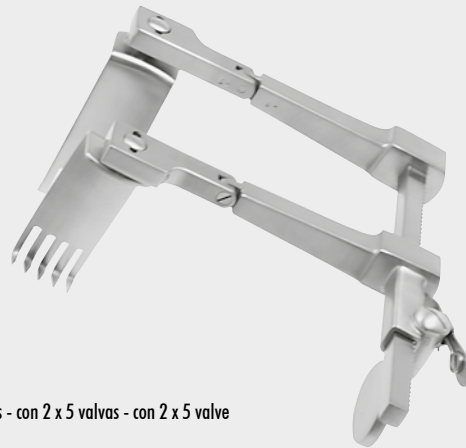

CASPAR		
18-7193-00	compl.	mit 2 x 5 Valven - with 2 x 5 blades - avec 2 x 5 valves - con 2 x 5 valvas - con 2 x 5 valve
18-7193-12	allein	- only - seul - suelto - solo

WUNDHAKEN
WUNDSPERRER

RETRACTORS

ÉCARTEURS

SEPARADORES

DIVARICATORI

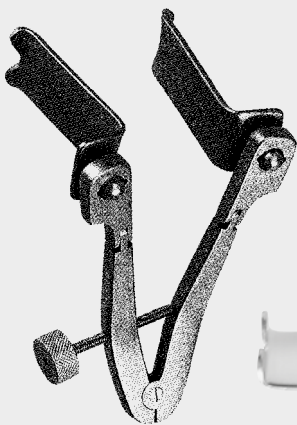

CASPAR	
18-7200-45	45 x 23 mm
18-7200-50	50 x 23 mm
18-7200-55	55 x 23 mm
18-7200-60	60 x 23 mm
18-7200-65	65 x 23 mm

CASPAR	
18-7203-45	45 x 25 mm
18-7203-50	50 x 25 mm
18-7203-55	55 x 25 mm
18-7203-60	60 x 25 mm
18-7203-65	65 x 25 mm



CASPAR		
18-7195-00	compl.	mit 5 Valven - compl. with 5 blades - complet avec 5 valves - completo con 5 valvas - completo di 5 valve
18-7195-11	allein	Sperrer (Spekulumausführung) allein - Retractor (Speculum pattern) only - Écarteur (modèle spéculum) seul Separador (modelo espéculo) suelto - Divaricatore (modello specolo) solo

cm	
11,0	18-7198-11

Pinzette zum Blattwechsel
Forceps to exchange blades
Pince pour changer les valves
Pinza para cambiar valvas
Pinza per cambiare valve

ZEPF®
INSTRUMENTS

18-7198-11

18.53

Sperrer für die Laminectomie
 Spreaders for Laminectomy
 Écarteurs par la laminectomie
 Separadores para laminectomía
 Divaricatori per laminectomia

WUNDHAKEN WUNDSPERRER

RETRACTORS

ÉCARTEURS

SEPARADORES

DIVARICATORI

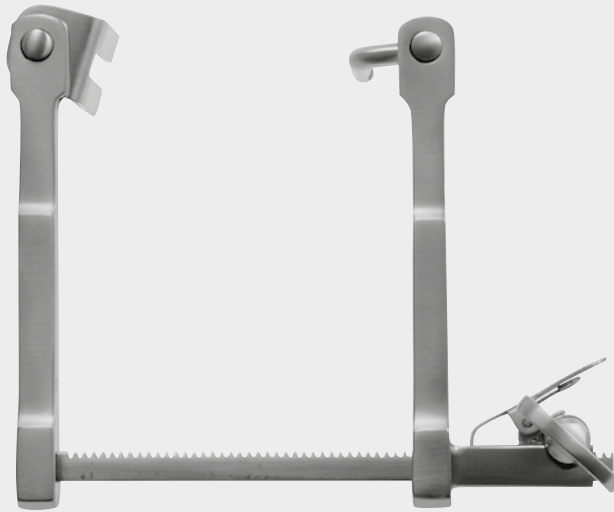

CASPAR

18-7300-00 compl.

mit je 1 - with 1 ea. - avec 1 chacun - con 1 c/u - con 1 ciascuno:
 18-7301-50, 18-7302-40, 18-7302-45, 18-7302-50, 18-7302-55, 18-7302-60



CASPAR

18-7301-50 50 mm



CASPAR

18-7301-70 70 mm



CASPAR

18-7302-35 35 x 22 mm

18-7302-40 40 x 22 mm

18-7302-45 45 x 22 mm

18-7302-50 50 x 22 mm

18-7302-55 55 x 22 mm

18-7302-60 60 x 22 mm

18-7302-65 65 x 22 mm

18-7302-70 70 x 22 mm



CASPAR

18-7300-15

Sperrer allein - Spreader only - Écarteur seul
 Separador suelto - Divaricatore solo

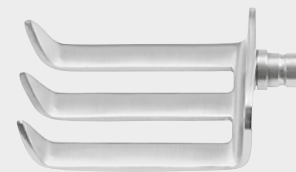

CASPAR

18-7303-35 35 x 37 mm

18-7303-40 40 x 37 mm

18-7303-45 45 x 37 mm

18-7303-50 50 x 37 mm

18-7303-55 55 x 37 mm

18-7303-60 60 x 37 mm

18-7303-65 65 x 37 mm

18-7303-70 70 x 37 mm



CASPAR

18-7304-35 35 x 52 mm

18-7304-40 40 x 52 mm

18-7304-45 45 x 52 mm

18-7304-50 50 x 52 mm

18-7304-55 55 x 52 mm

18-7304-60 60 x 52 mm

18-7304-65 65 x 52 mm

18-7304-70 70 x 52 mm

ZEPF[®]
α
 INSTRUMENTS

18-7300-00

18.54

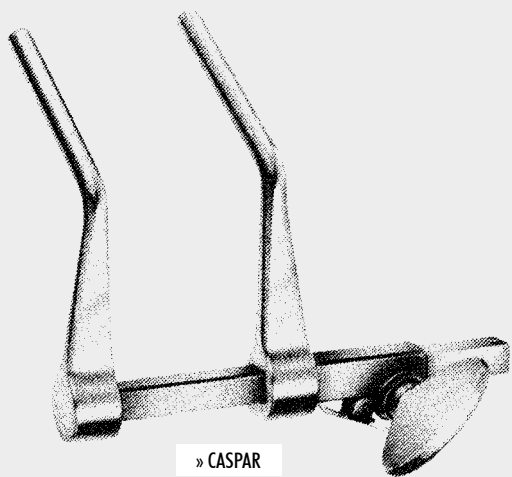

» CASPAR
18-7306-01

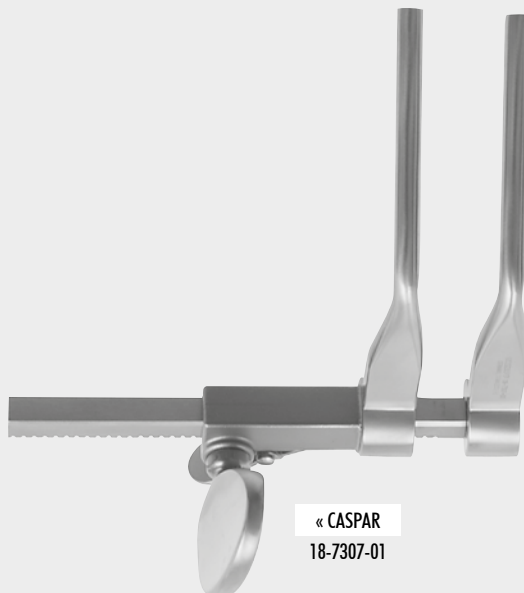

« CASPAR
18-7307-01

18-7306-00 CASPAR Wirbelkörperdistraktor für Op an unterer und mittlerer Halswirbelsäule von rechts, bestehend aus:
 CASPAR vertebral body distractor for use in surgical procedures of the cervical spine from the right, consisting of:
 CASPAR distracteur des corps vertébraux pour la chirurgie de la colonne cervicale, accès du côté droit, composé de:
 CASPAR distractor de los cuerpos vertebrales para la cirugía de la columna cervical, acceso del lado derecho, compuesto de:
 CASPAR distrattore dei corpi vertebrali per la chirurgia della colonna cervicale, acceso del lato destro, composto da:
 18-7306-01, 18-7306-02, 18-7306-10, 18-7306-16 (2x), 18-7306-20

18-7307-00 dito, von links - idem, from the left - idem, du côté gauche - idem, del lado izquierdo - detto, del lato sinistro:
 18-7307-01, 18-7307-02, 18-7306-10, 18-7306-16 (2x), 18-7306-20

CASPAR Distraktoren
 CASPAR Distactors
 CASPAR Distracteurs
 CASPAR Distractors
 CASPAR Distrattori

WUNDHAKEN
 WUNDSPERRER

RETRACTORS

ÉCARTEURS

SEPARADORES

DIVARICATORI

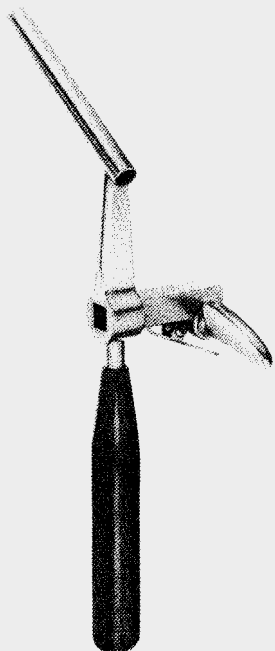

» CASPAR
18-7306-02

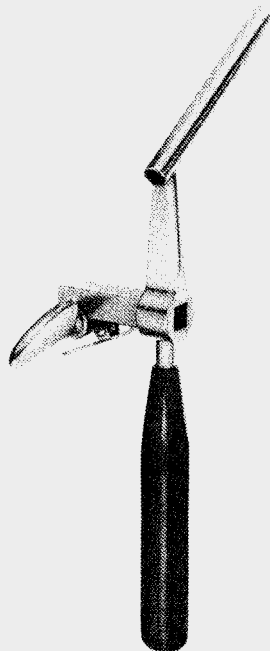

« CASPAR
18-7307-02



cm CASPAR
14,5 18-7306-10



mm CASPAR
14,0 18-7306-14
16,0 18-7306-16
18,0 18-7306-18



cm CASPAR
20,0 18-7306-20

Bohrerführungen allein, rechts - links
 Drill Guides only, right - left side
 Guides de forets, à droite - à gauche
 Guías de perforadores, a la derecha - a la izquierda
 Guide di perforatori, destra - sinistra

Spiralbohrer
 Twist Drill
 Foret
 Perforador
 Perforatore

Distraktions-Schrauben
 Distraction Screws
 Vis de distraction
 Tornillos de distracción
 Viti di distrazione

Schraubendreher
 ScrewDriver
 Tournevis
 Destornillador
 Giravite



18-7306-20

18.55

Wundspreizer zur Mikrodiskektomie
 Retractors for Micro-Lumbar Discectomy
 Écarteurs pour la micro-disquectomie lombaire
 Separadores para la microdiscectomía lumbar
 Divaricatori per la micro discectomia lombare

WUNDHAKEN WUNDSPERRER

RETRACTORS

ÉCARTEURS

SEPARADORES

DIVARICATORI

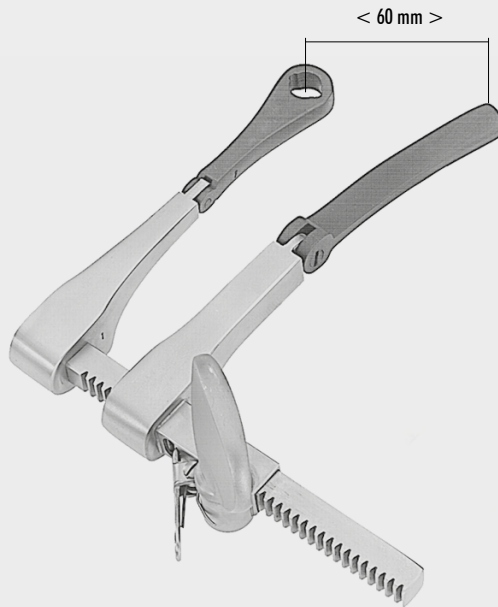

18-7308-35*	35 mm
18-7308-40*	40 mm
18-7308-45*	45 mm
18-7308-50*	50 mm
18-7308-55*	55 mm
18-7308-60*	60 mm
18-7308-65	65 mm
18-7308-75	75 mm
18-7308-85	85 mm

CASPAR

18-7308-00 compl.* mit 6 Valven - with 6 blades - avec 6 valves - con 6 valvas - con 6 valve

18-7308-01 Gegensperrerr allein

Counter-Retractor only

Contre-écarteur seul

Contra-separador suelto

Contra-divaricatore solo

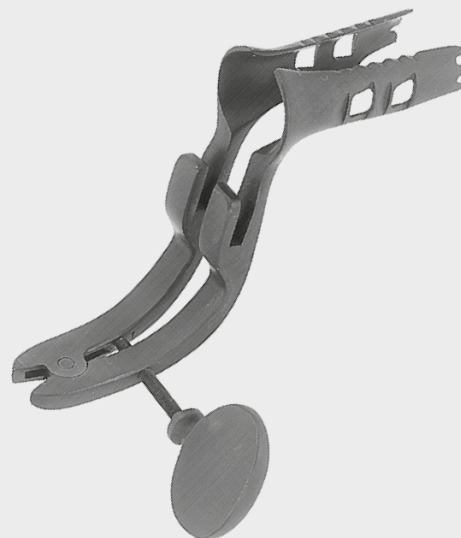

Blattlänge
 Length of Blade
 Longueur de la valve
 Largo de la valva
 Lunghezza della valva

18-7310-40	40 mm
18-7310-45	45 mm
18-7310-50	50 mm
18-7310-55	55 mm
18-7310-60	60 mm
18-7310-65	65 mm
18-7310-75	75 mm
18-7310-85	85 mm

CASPAR

18-7310-40 - 18-7310-85

ZEPF[®]

 INSTRUMENTS

18-7308-00

18.56

3x3



cm CAIRNS
14,5 18-7490-14

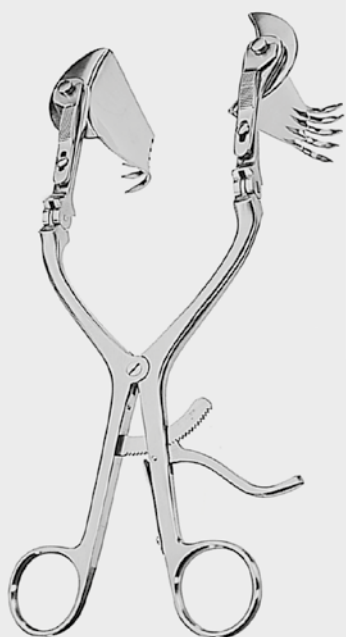

cm CLOWARD HOEN
31,0 18-7501-25



2x2



cm HOEN
27,0 18-7503-27

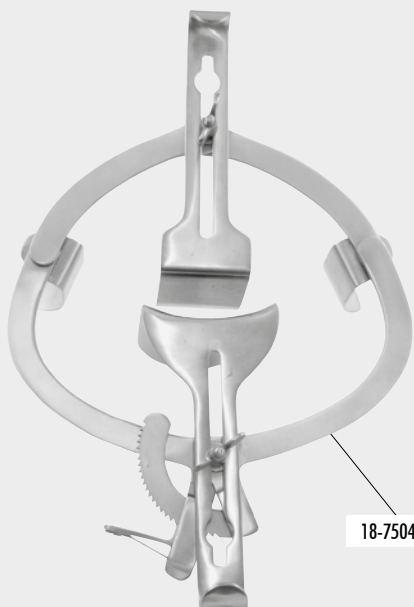

O'SULLIVAN-O'CONNOR
18-7504-00 - 18-7504-10

18-7504-10



1 18-7504-01 110 x 70 mm

2 18-7504-02 80 x 45 mm

3 18-7504-03 80 x 45 mm

Cervical-Sperrer
Cervical Spreaders
Écarteurs cervicaux
Separadores cervicales
Divaricatori cervicali

WUNDHAKEN
WUNDSPERRER

RETRACTORS

ÉCARTEURS

SEPARADORES

DIVARICATORI

Bauchdeckenhalter
Abdominal Retractors
Écarteurs abdominaux
Separadores abdominales
Divaricatori addominali

ZEPF®
INSTRUMENTS

18-7504-03

18.57

Bauchdeckenhalter
 Abdominal Retractor
 Écarteur abdominal
 Separador abdominal
 Divaricatore addominale

WUNDHAKEN
 WUNDSPERRER

RETRACTORS

ÉCARTEURS

SEPARADORES

DIVARICATORI

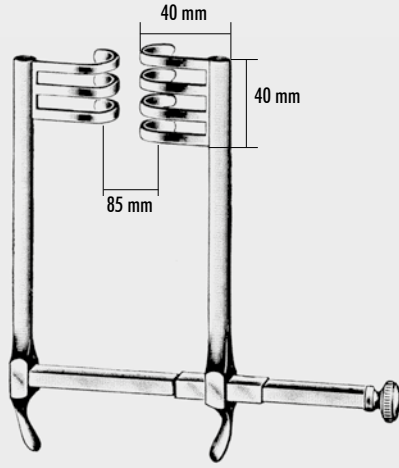

cm FRAZIER
 8,5 18-7508-85

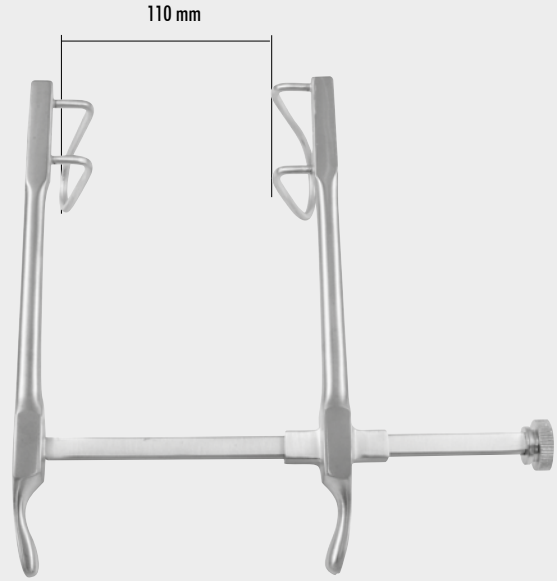

cm GOSSET
 11,0 18-7600-10

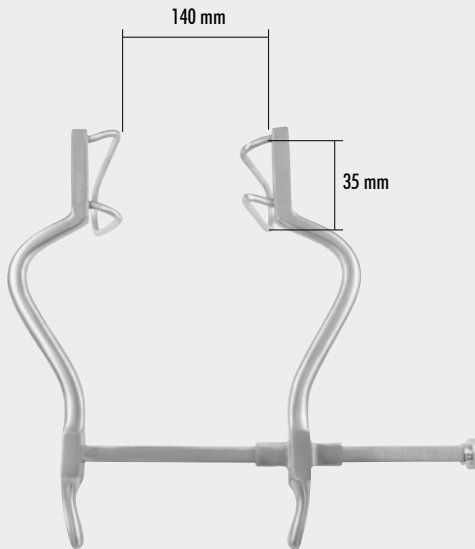

GOSSET
 18-7600-14

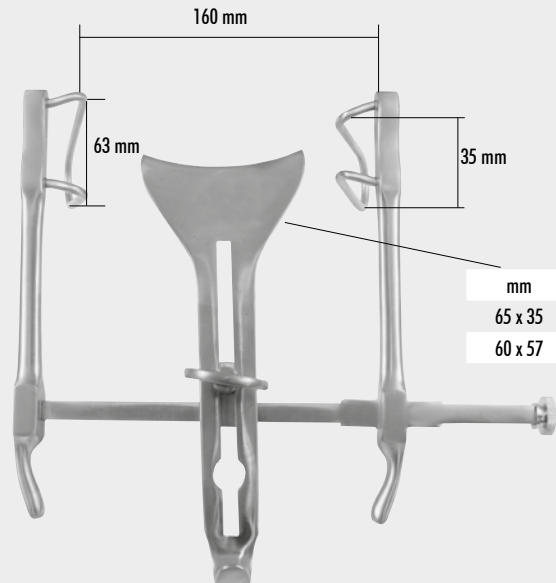

cm GOSSET
 16,0 18-7602-16

mm	
65 x 35	18-7602-21
60 x 57	18-7602-22



18-7508-85

18.58

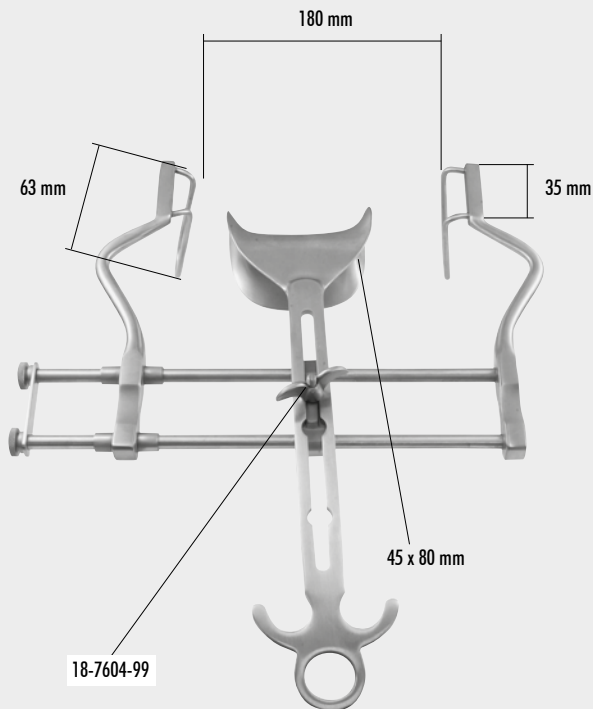

cm BALFOUR
18,0 18-7604-18

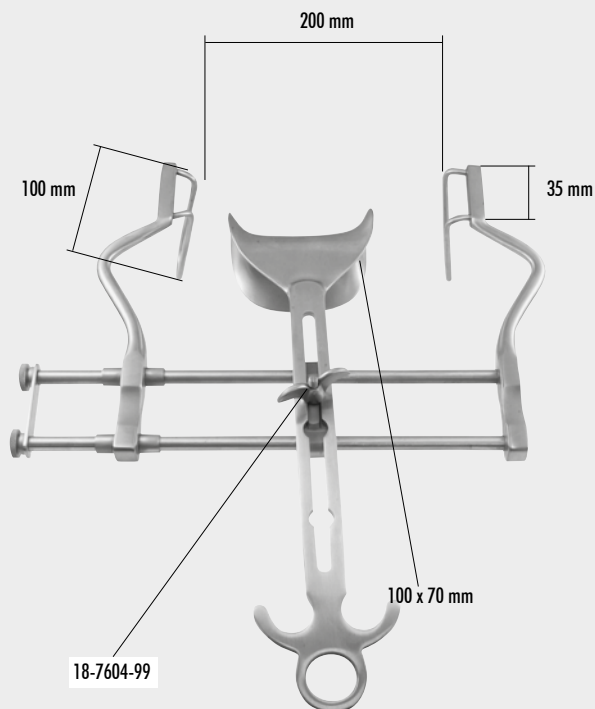

cm BALFOUR
20,0 18-7604-20

Bauchdeckenhalter
Abdominal Retractors
Écarteurs abdominaux
Separadores abdominales
Divaricatori addominali

WUNDHAKEN
WUNDSPERRER

RETRACTORS

ÉCARTEURS

SEPARADORES

DIVARICATORI

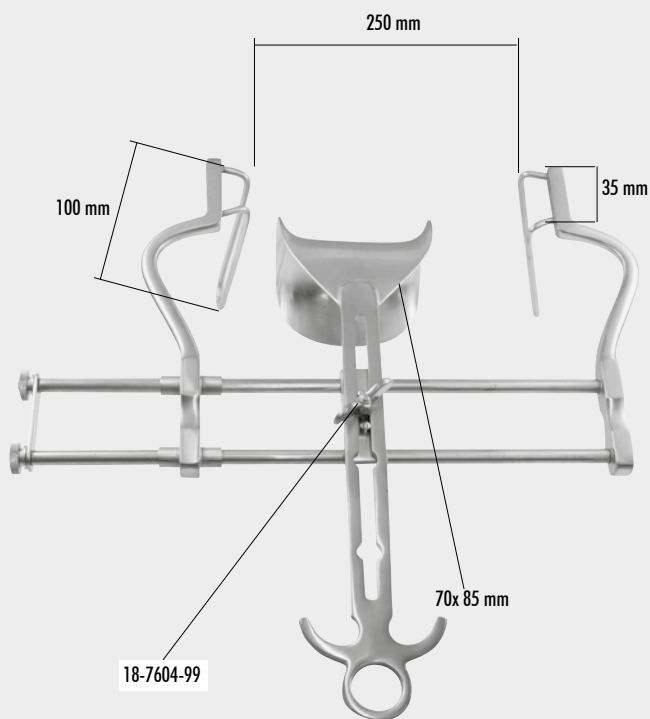

cm BALFOUR
25,0 18-7604-25



mm HORGAN
125 x 54 18-7607-12

mm	BALFOUR
40 x 68	18-7605-40
45 x 80	18-7605-45
68 x 85	18-7605-68
70 x 85	18-7605-70
80 x 90	18-7605-80
100 x 70	18-7605-90

ZEPF®
INSTRUMENTS

18-7607-12

18.59

Bauchdeckenhalter
Abdominal Retractors
Écarteurs abdominaux
Separadores abdominales
Divaricatori addominali

**WUNDHAKEN
WUNDSPERRER**

RETRACTORS

ÉCARTEURS

SEPARADORES

DIVARICATORI

Bauchdeckenhalter, Draht-Valven
Abdominal Retractors, Wire Blades
Écarteurs abdominaux, Valves en fil métallique
Separadores abdominales, vlvavas de hilo metálico
Divaricatori addominali, Valve in filo metalico

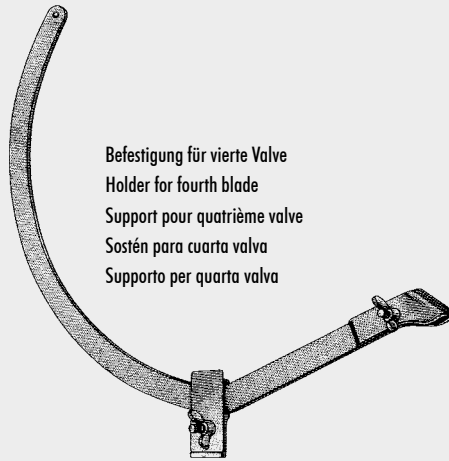

Befestigung für vierte Valve
Holder for fourth blade
Support pour quatrième valve
Sostén para cuarta valva
Supporto per quarta valva

» BALFOUR «
18-7608-02 18-7608-03



cm BALFOUR
18,0 18-7610-18

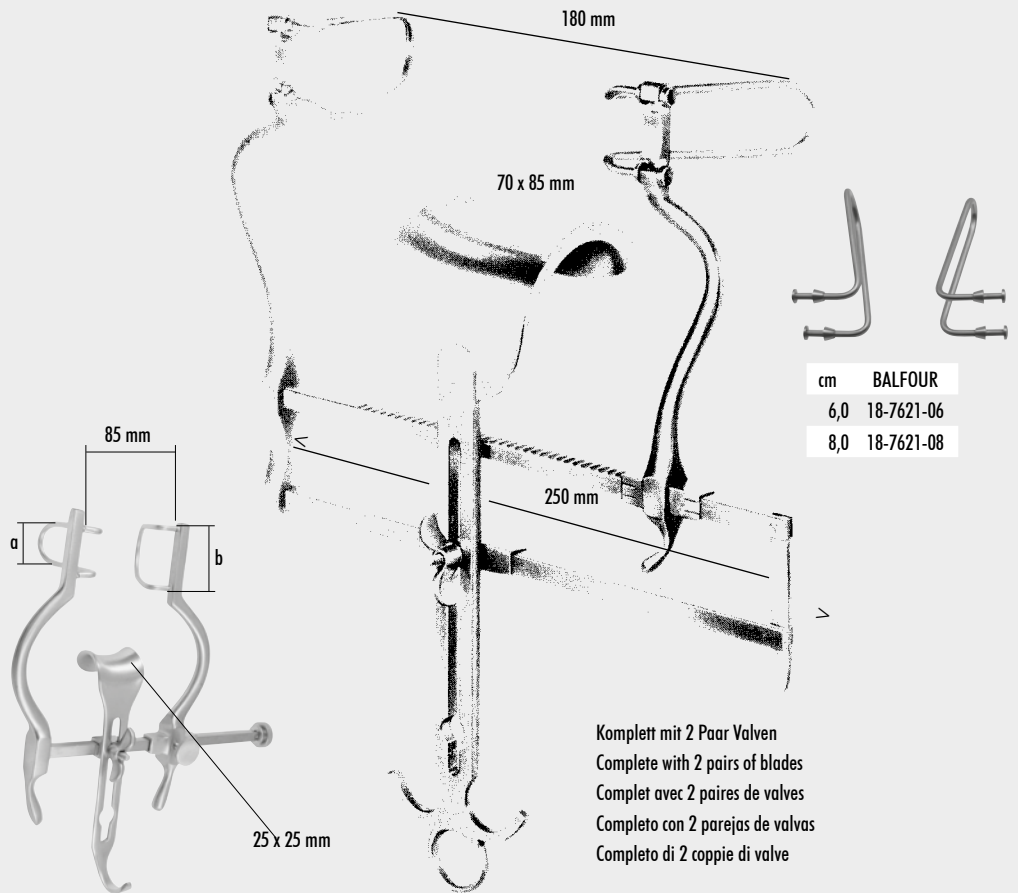

cm BALFOUR
6,0 18-7621-06
8,0 18-7621-08

Komplett mit 2 Paar Valven
Complete with 2 pairs of blades
Complet avec 2 paires de valves
Completo con 2 parejas de valvas
Completo di 2 coppie di valve

cm BALFOUR Baby
9,0 18-7610-90

cm BALFOUR US
25,0 18-7620-25

a 27 x 28
b 20 x 28



18-7608-02

18.60

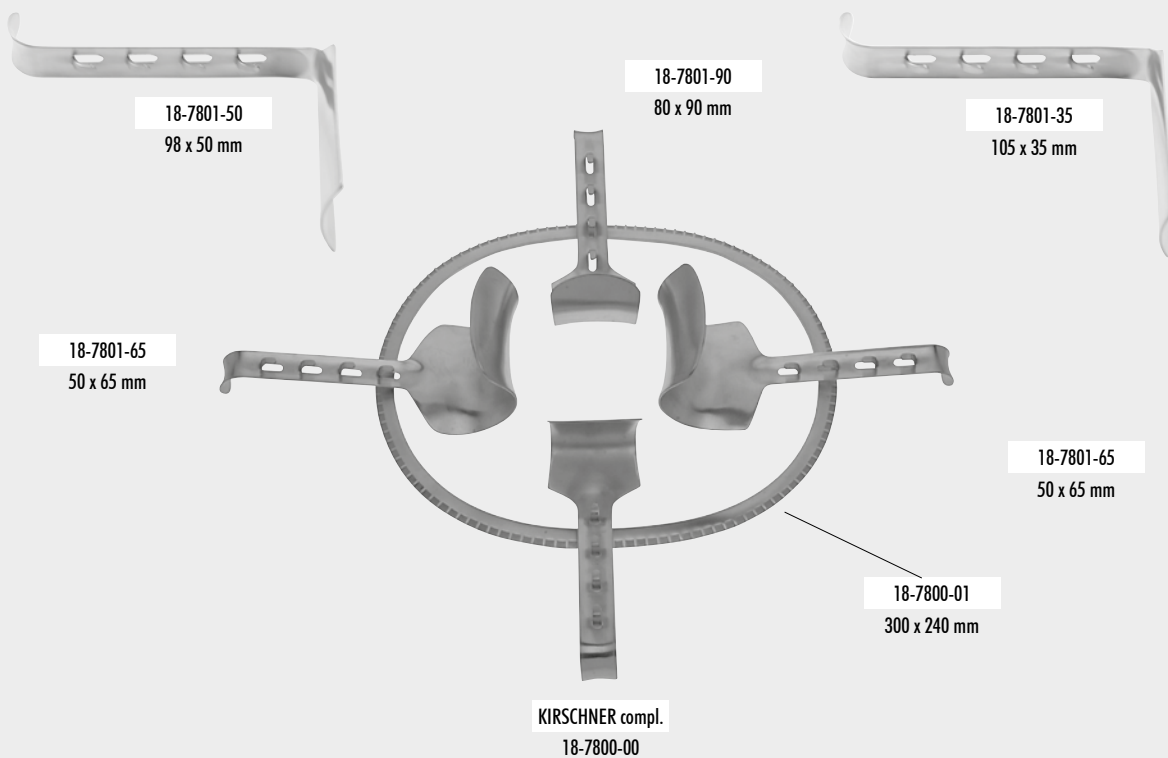

Bauchdeckenhalter
Abdominal Retractors
Écarteurs abdominaux
Separadores abdominales
Divaricatori addominali

WUNDHAKEN
WUNDSPERRER

RETRACTORS

ÉCARTEURS

SEPARADORES

DIVARICATORI

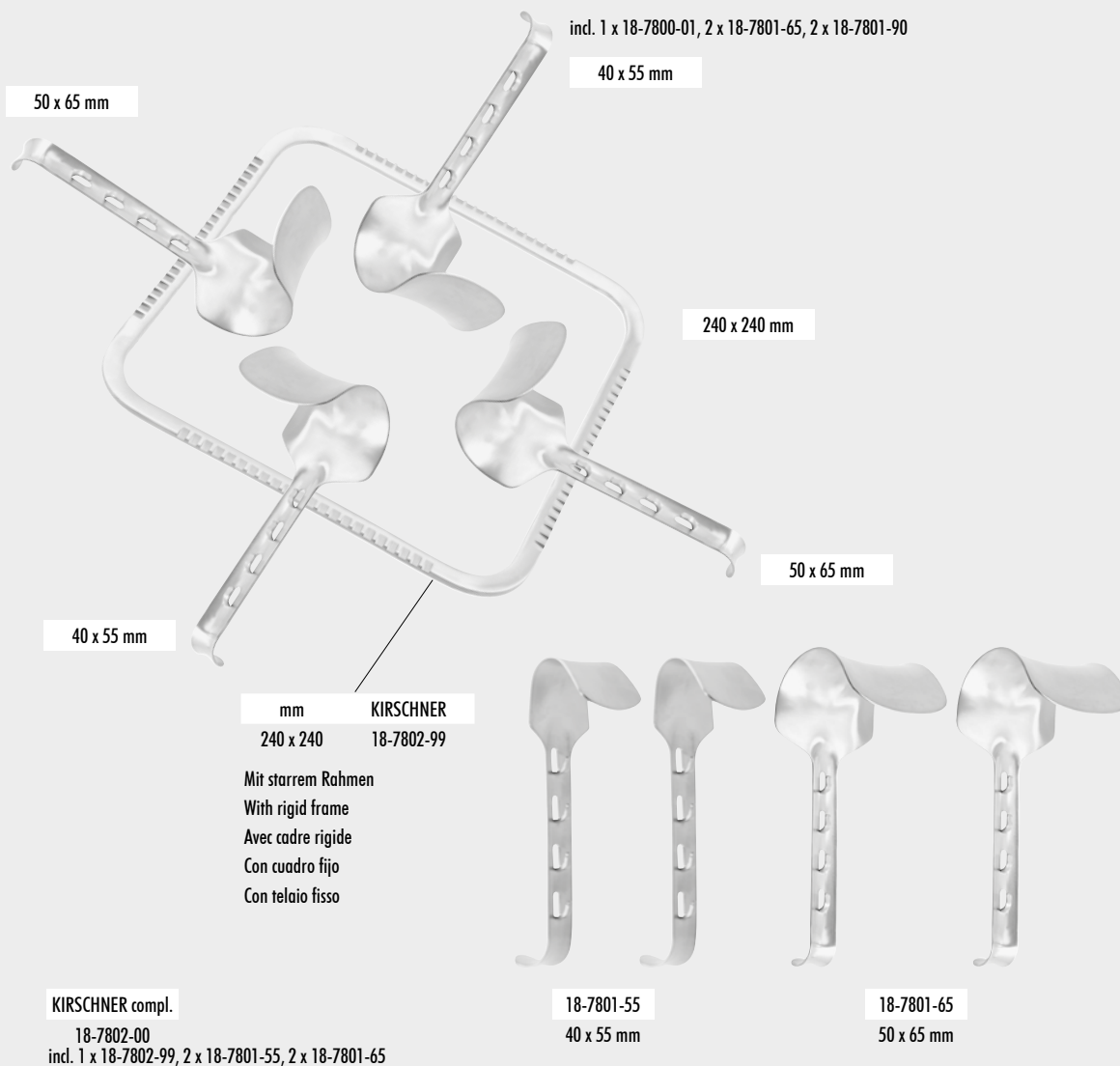

18-7801-65

18.61



Bauchdeckenhalter
Abdominal Retractors
Écarteurs abdominaux
Separadores abdominales
Divaricatori addominali

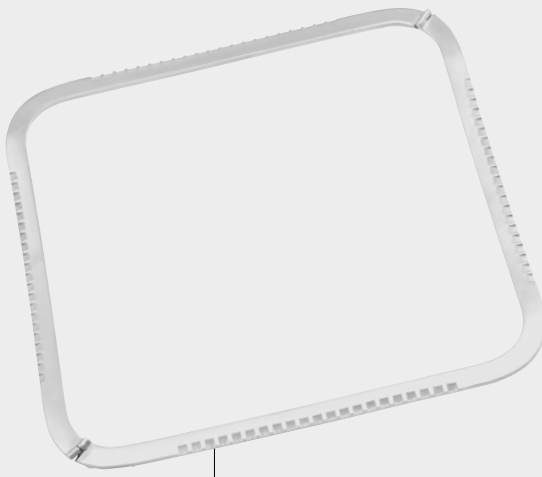

mm	KIRSCHNER
250 x 250	18-7804-01

Mit zusammenlegbarem Rahmen
With folding frame
Avec cadre pliant
Con cuadro plegable
Con telaio pieghevole



18-7801-55
40 x 55 mm

18-7801-65
50 x 65 mm

KIRSCHNER compl.
18-7804-00
incl. 1 x 18-7804-01, 2 x 18-7801-55, 2 x 18-7801-65

**WUNDHAKEN
WUNDSPERRER**

RETRACTORS

ÉCARTEURS

SEPARADORES

DIVARICATORI

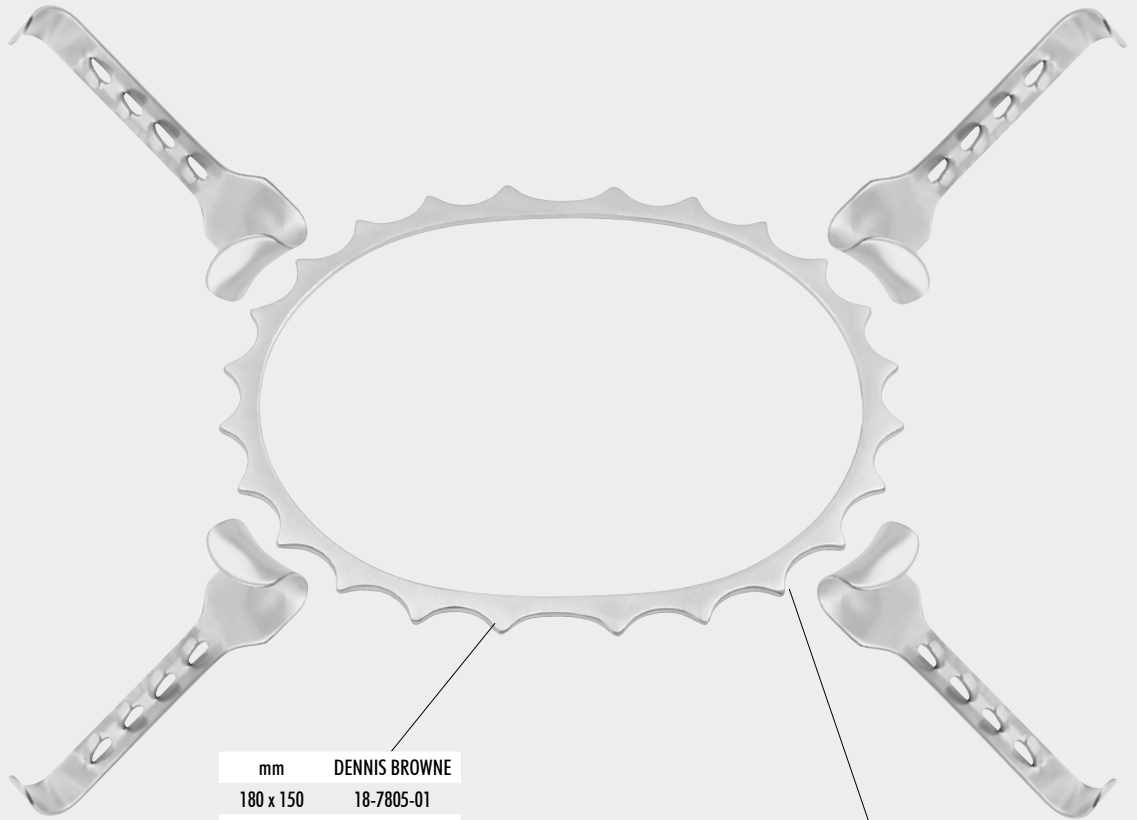

mm	DENNIS BROWNE
180 x 150	18-7805-01
255 x 180	18-7805-02

mm	
13 x 13	18-7805-13
40 x 30	18-7805-30
20 x 30	18-7805-31
38 x 38	18-7805-38
40 x 40	18-7805-40
20 x 40	18-7805-41
64 x 19	18-7805-64

DENNIS BROWNE compl.
18-7805-00
incl. 1 x 18-7805-01, 2 x 18-7805-30, 2 x 18-7805-40



18-7804-01

18.62

Bauchdeckenhalter, Rahmen allein
 Abdominal Retractors, Frames only
 Écarteurs abdominaux, cadres seuls
 Separadores abdominales cuadros sueltos
 Divaricatori addominali, telai soli

**WUNDHAKEN
 WUNDSPERRER**

RETRACTORS

ÉCARTEURS

SEPARADORES

DIVARICATORI



18-7808-05

18.63

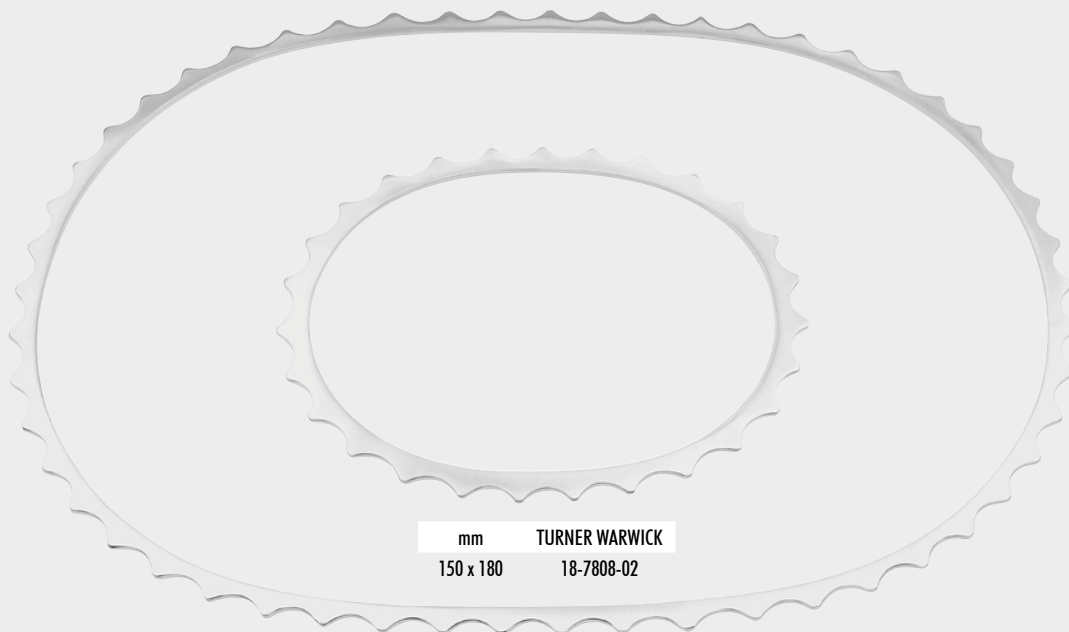

mm	TURNER WARWICK
150 x 180	18-7808-02

mm	TURNER WARWICK
300 x 400	18-7808-01

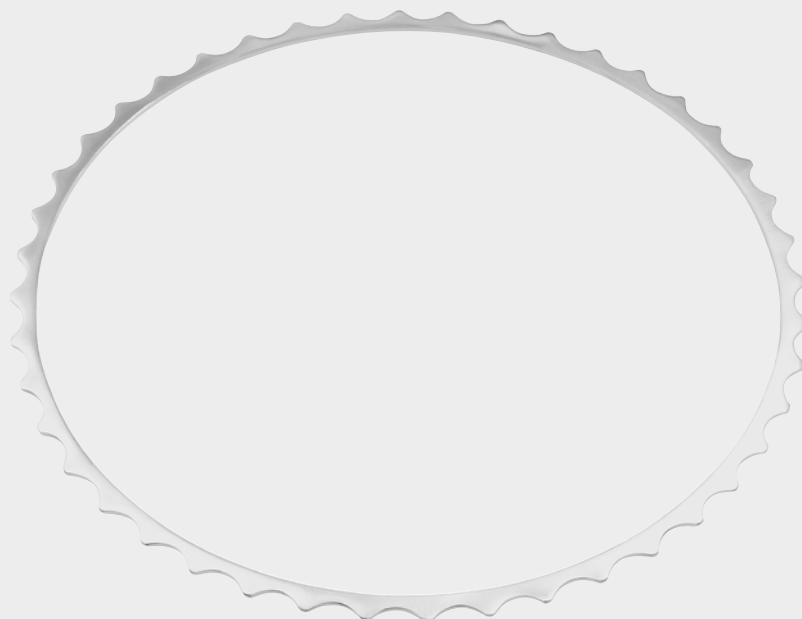

mm	TURNER WARWICK
300	18-7808-03
100	18-7808-04
250	18-7808-05



Bauchdeckenhalter, Valven allein
 Abdominal Retractors, Blades only
 Écarteurs abdominaux, valves seules
 Separadores abdominales valvas sueltas
 Divaricatori addominali, valve sole

**WUNDHAKEN
 WUNDSPERRER**



Hochglanz
 Mirror Finish
 Polie brillante
 Pulida brillante
 Pulita brillante

Biegsam
 Malleable
 Malléable
 Maleable
 Malleabile

mm TURNER WARWICK
 20 x 60 18-7808-10

mm TURNER WARWICK
 55 x 105 18-7808-11

mm TURNER WARWICK
 30 x 32 18-7808-12

mm TURNER WARWICK
 40 x 47 18-7808-13

RETRACTORS

ÉCARTEURS

SEPARADORES

DIVARICATORI



mm TURNER WARWICK
 60 x 75 18-7808-14



mm TURNER WARWICK
 70 x 120 18-7808-15



18-7808-10

18.64



mm TURNER WARWICK
70 x 90 18-7808-16



mm TURNER WARWICK
20 x 90 18-7808-22



mm TURNER WARWICK
13 x 13 18-7808-33

Hochglanz
Mirror Finish
Polie brillante
Pulida brillante
Pulita brillante

Biegsam
Malleable
Malléable
Maleable
Malleabile

Bauchdeckenhalter, Valven allein
Abdominal Retractors, Blades only
Écarteurs abdominaux, valves seules
Separadores abdominales valvas sueltas
Divaricatori addominali, valve sole

WUNDHAKEN
WUNDSPERRER

RETRACTORS

ÉCARTEURS

SEPARADORES

DIVARICATORI



mm TURNER WARWICK
13 x 13 18-7808-34



mm TURNER WARWICK
13 x 13 18-7808-35

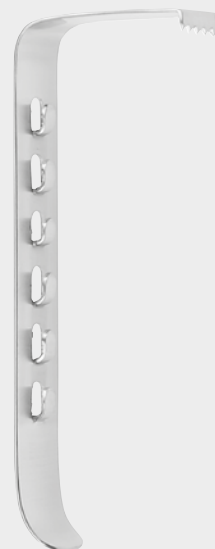

mm TURNER WARWICK
64 x 19 18-7808-36

Bauchdeckenhalter, komplette Sets
Abdominal Retractors, complete Sets
Écarteurs abdominaux, jeux complets
Separadores abdominales, juegos completos
Divaricatori addominali, set completi

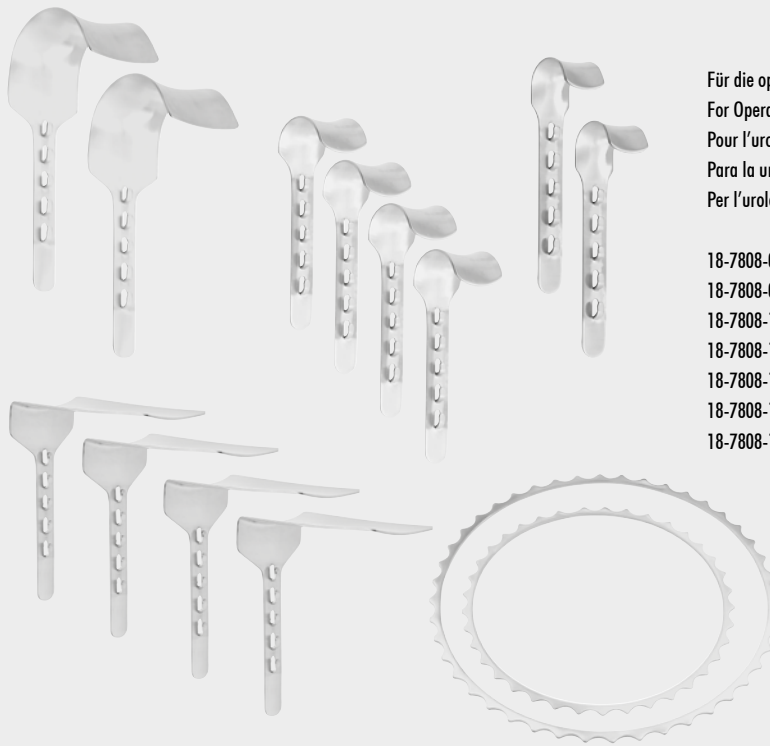

TURNER WARWICK compl.
18-7808-90

Für die operative Urologie, für Erwachsene, bestehend aus:
For Operative Urology, for Adults, Consisting of:
Pour l'urologie opérative, pour adultes, composé de:
Para la urología operativa en adultos, compuesto de:
Per l'urologia operativa di adulti, composto da:

18-7808-03	1 Stück
18-7808-05	1 Stück
18-7808-12	2 Stück
18-7808-13	4 Stück
18-7808-14	2 Stück
18-7808-16	2 Stück
18-7808-15	2 Stück

WUNDHAKEN WUNDSPERRER

RETRACTORS

ÉCARTEURS

SEPARADORES

DIVARICATORI



Für die operative Urologie, für Kinder, bestehend aus:
For Operative Urology, for Children, Consisting of:
Pour l'urologie opérative, pour enfants, composé de:
Para la urología operativa en niños, compuesto de:
Per l'urologia operativa di bambini, composto da:

18-7808-02	1 Stück
18-7808-33	6 Stück
18-7808-12	2 Stück
18-7808-10	1 Stück



TURNER WARWICK compl.
18-7808-91

Für Urethroplastik, bestehend aus:
For Urethroplasties, consisting of:
Pour l'urétéroplastie, composé de:
Para ureteroplastia, compuesto de:
Per ureteroplastia, composto da:

18-7808-02	1 Stück
18-7808-33	4 Stück



TURNER WARWICK compl.
18-7808-92

Bauchdeckenhalter, Rahmen allein
 Abdominal Retractors, Frames only
 Écarteurs abdominaux, cadres seuls
 Separadores abdominales cuadros sueltos
 Divaricatori addominali, telai soli

**WUNDHAKEN
 WUNDSPERRER**

RETRACTORS

ÉCARTEURS

SEPARADORES

DIVARICATORI

Bauchdeckenhalter, Valven allein
 Abdominal Retractors, Blades only
 Écarteurs abdominaux, valves seules
 Separadores abdominales valvas sueltas
 Divaricatori addominali, valve sole



18-7815-01

18.67



ø mm	TURNER WARWICK
180	18-7812-18
230	18-7812-23
305	18-7812-30

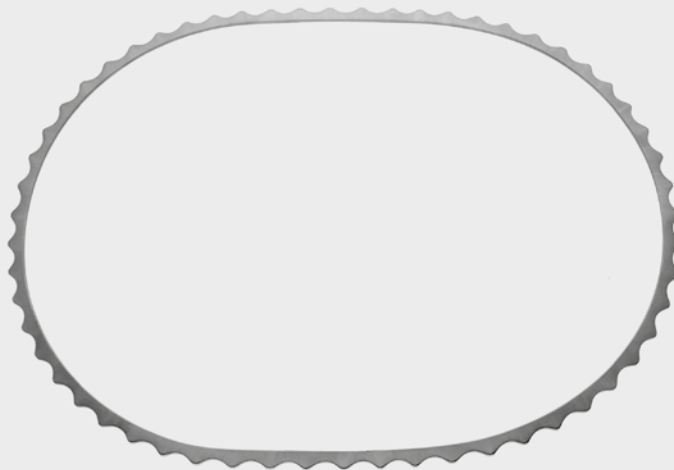

mm	TURNER WARWICK
457 x 330	18-7812-45

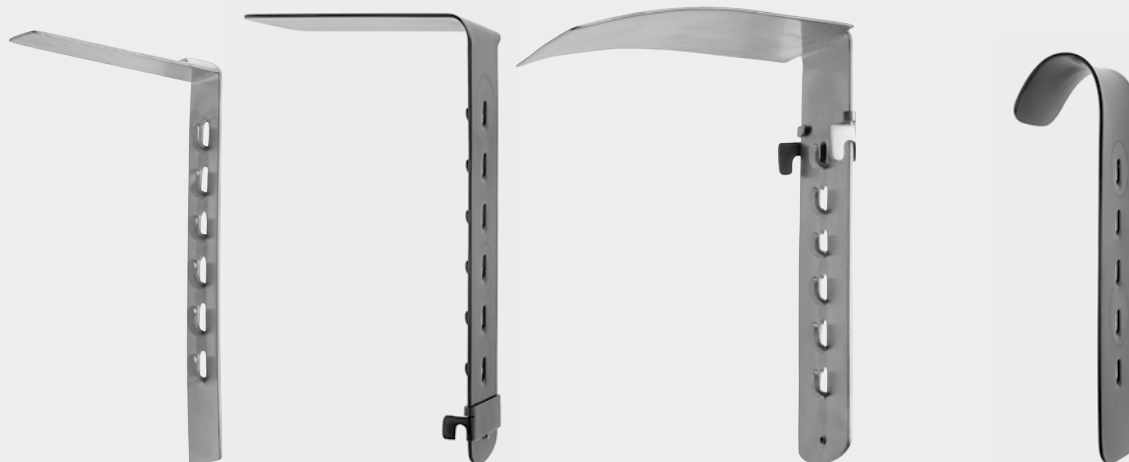

mm	TURNER WARWICK
76 x 19	18-7813-01

mm	TURNER WARWICK
102 x 38	18-7813-02
89 x 57	18-7813-03

mm	TURNER WARWICK
114 x 57	18-7813-04

mm	TURNER WARWICK
51 x 38	18-7815-01

Bauchdeckenhalter, Valven allein
 Abdominal Retractors, Blades only
 Écarteurs abdominaux, valves seules
 Separadores abdominales, valvas sueltas
 Divaricatori addominali, valve sole

WUNDHAKEN WUNDSPERRER

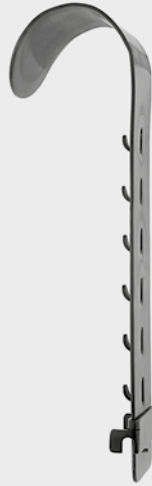

mm TURNER WARWICK
 76 x 60 18-7815-02



mm TURNER WARWICK
 89 x 60 18-7815-03
 114 x 60 18-7815-04



mm TURNER WARWICK
 13 18-7815-05

RETRACTORS

ÉCARTEURS

SEPARADORES

DIVARICATORI

Bauchdeckenhalter, komplett
 Abdominal Retractor, Complete
 Écarteur abdominal, complet
 Separador abdominal, completo
 Divaricatore addominale, completo

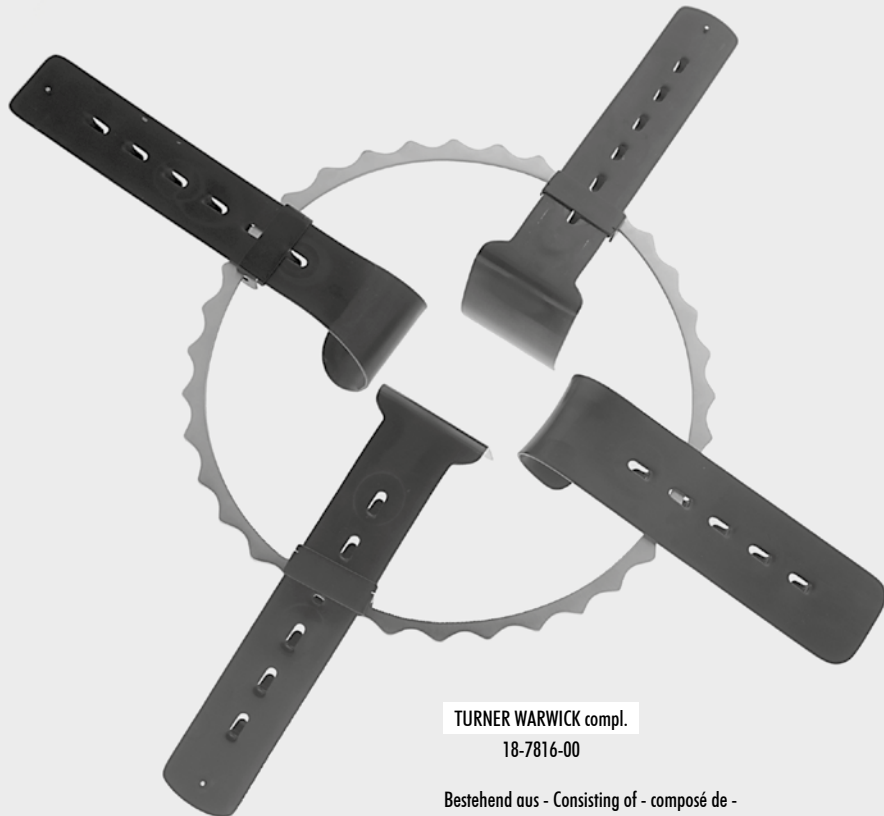

TURNER WARWICK compl.
 18-7816-00

Bestehend aus - Consisting of - composé de -
 compuesto de - composto da:

18-7812-18	1	18-7813-04	2
18-7812-23	1	18-7815-01	2
18-7812-30	1	18-7815-02	2
18-7813-01	2	18-7815-03	2
18-7813-02	2	18-7815-04	2
18-7813-03	2	18-7815-05	2

ZEPF®

 INSTRUMENTS

18-7815-02

18.68



cm HUSTINX
23,0 18-8001-23



1x1

cm GELPI
9,0 18-8002-09
11,0 18-8002-11
14,0 18-8002-14
16,0 18-8002-16
18,0 18-8002-18



1x1

cm GELPI
18,0 18-8004-18

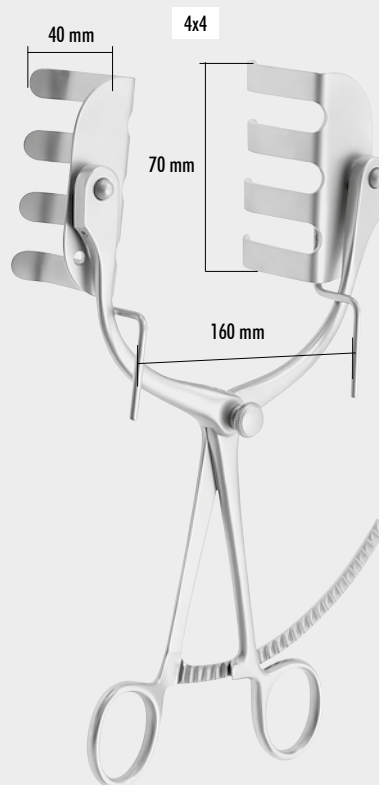

cm Sr. MARKS
22,0 18-8005-22

WUNDHAKEN
WUNDSPERRER

RETRACTORS

ÉCARTEURS

SEPARADORES

DIVARICATORI



mm RIGBY 18,0 cm
35 x 20 18-8006-35
60 x 20 18-8006-60



1x1

cm DE BAKEY Femur
10,0 18-8007-10
für Kinder - child size - pour enfants - para niños - per bambini



cm RICHTER
16,0 18-8008-16

cm DE BAKEY Femur
14,0 18-8007-14
für Erwachsene - adult size - pour adultes - para adultos - per adulti

Bauchdeckenhalter
 Abdominal Retractors
 Écarteurs abdominaux
 Separadores abdominales
 Divaricatori addominali

WUNDHAKEN
 WUNDSPERRER

RETRACTORS

ÉCARTEURS

SEPARADORES

DIVARICATORI

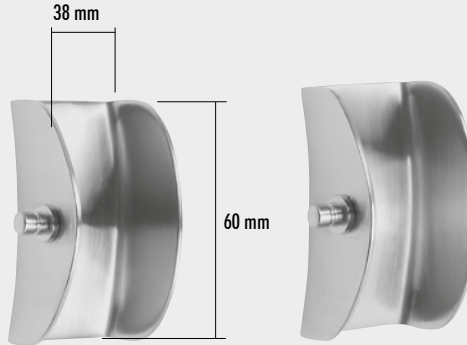

COLLIN
 18-8100-22

Bestehend aus: Sperrer, 1 Paar Valven
 Consisting of: Spreader, 1 pair of blades
 Consistant de: Écarteur, 1 paire de valves
 Compuesto de: Separador, 1 pareja de valvas
 Composto da: Divaricatore, 1 paia di valve



Central / mm	COLLIN	Lateral a x b mm
38 x 55	18-8102-60	60 x 38
50 x 75	18-8102-80	80 x 38

Bestehend aus: Sperrer, 1 Paar Valven, 1 Mittelvalve
 Consisting of: Spreader, 1 pair of blades, 1 central blade
 Consistant de: Écarteur, 1 paire de valves, 1 valva centrale
 Compuesto de: Separador, 1 pareja de valvas, 1 valva central
 Composto da: Divaricatore, 1 paia di valve, 1 valva centrale



18-8100-22

18.70

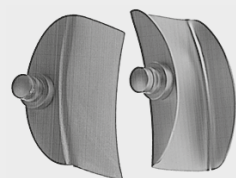

18-8104-11

18 x 42 mm

18-8104-12

28 x 42 mm



cm COLLIN Baby

18,0 18-8104-18

- Bestehend aus: Sperrer und 2 Paar Valven
- Consisting of: Spreader and 2 pairs of blades
- Consistant de: Écarteur et 2 paires de valves
- Compuesto de: Separador y 2 pares de valvas
- Composto da: Divaricatore e 2 paia di valve

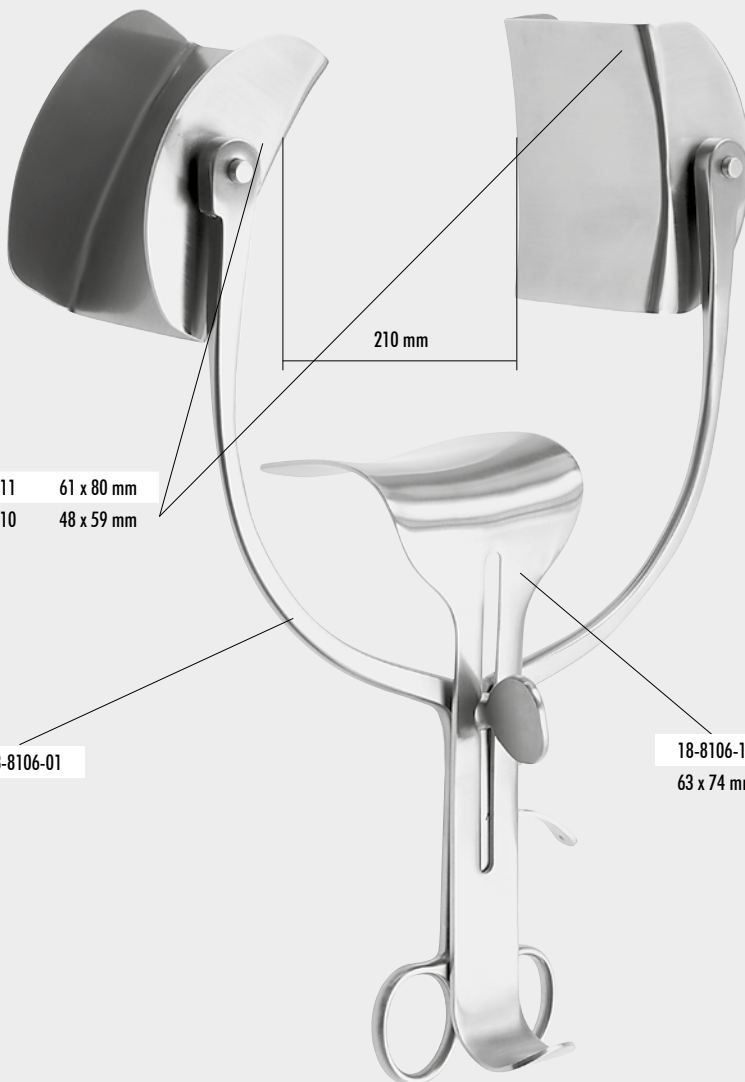

18-8106-11 61 x 80 mm

18-8106-10 48 x 59 mm

18-8106-01

18-8106-12

63 x 74 mm

COLLIN Loktite compl.

18-8106-00 (+ 18-8106-01 / 2x 18-8106-11 / 18-8106-12)

18-8106-02 (+ 18-8106-01 / 2x 18-8106-10 / 18-8106-12)

- Bestehend aus: Sperrer, 1 Paar Valven, 1 Mittelvalve
- Consisting of: Spreader, 1 pair of blades, 1 central blade
- Consistant de: Écarteur, 1 paire de valves, 1 valve centrale
- Compuesto de: Separador, 1 pareja de valvas, 1 valva central
- Composto da: Divaricatore, 1 paia di valve, 1 valva centrale

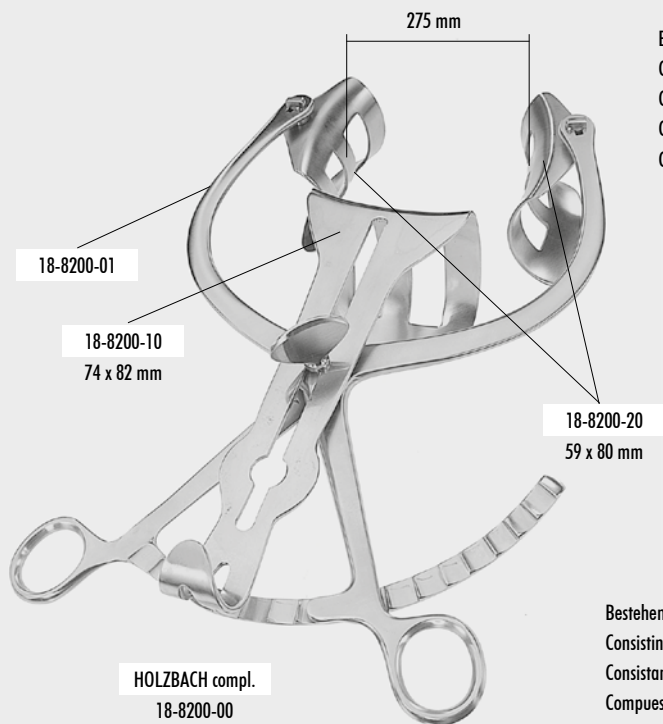

18-8200-01

18-8200-10

74 x 82 mm

18-8200-20

59 x 80 mm

HOLZBACH compl.

18-8200-00

- Bestehend aus: Sperrer, 1 Paar Valven, 1 Mittelvalve
- Consisting of: Spreader, 1 pair of blades, 1 central blade
- Consistant de: Écarteur, 1 paire de valves, 1 valve centrale
- Compuesto de: Separador, 1 pareja de valvas, 1 valva central
- Composto da: Divaricatore, 1 paia di valve, 1 valva centrale

Bauchdeckenhalter
Abdominal Retractors
Écarteurs abdominaux
Separadores abdominales
Divaricatori addominali

WUNDHAKEN
WUNDSPERRER

RETRACTORS

ÉCARTEURS

SEPARADORES

DIVARICATORI

ZEPF®
INSTRUMENTS

18-8200-20

18.71

Bauchdeckenhalter
Abdominal Retractors
Écarteurs abdominaux
Separadores abdominales
Divaricatori addominali

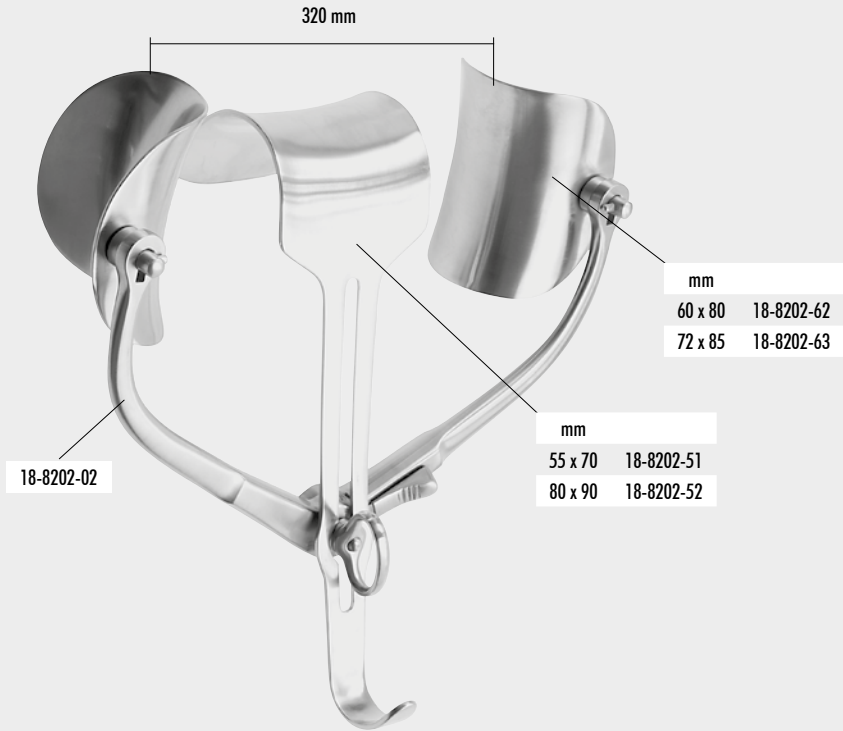

WUNDHAKEN
WUNDSPERRER

RETRACTORS

ÉCARTEURS

SEPARADORES

DIVARICATORI

cm	RICARD
28,0	18-8202-28 (+ 18-8202-02 / 18-8202-51 / 2x 18-8202-62)
30,0	18-8202-30 (+ 18-8202-02 / 18-8202-52 / 2x 18-8202-63)

Bestehend aus: Sperrer, 1 Paar Valven, 1 Mittelvalve
 Consisting of: Spreader, 1 pair of blades, 1 central blade
 Consistant de: Écarteur, 1 paire de valves, 1 valve centrale
 Compuesto de: Separador, 1 pareja de valvas, 1 valva central
 Composto da: Divaricatore, 1 paia di valve, 1 valva centrale



mm	DOYEN
55 x 95	18-8220-95
55 x 105	18-8221-05
55 x 115	18-8221-12
55 x 125	18-8221-25



DOYEN CHILD
18-8222-00



*Gewicht allein weight only poids seule pesa sola peso solo	g
	*250 18-8224-25
	*400 18-8224-40
	645 18-8224-64

ZEPF®
α
INSTRUMENTS

18-8202-02

18.72



OETTINGEN compl.
18-8254-00

Bestehend aus: Sperrer, 1 Paar Valven, 1 Mittelvalve
 Consisting of: Spreader, 1 pair of blades, 1 central blade
 Consistant de: Écarteur, 1 paire de valves, 1 valve centrale
 Compuesto de: Separador, 1 pareja de valvas, 1 valva central
 Composto da: Divaricatore, 1 paia di valve, 1 valva centrale

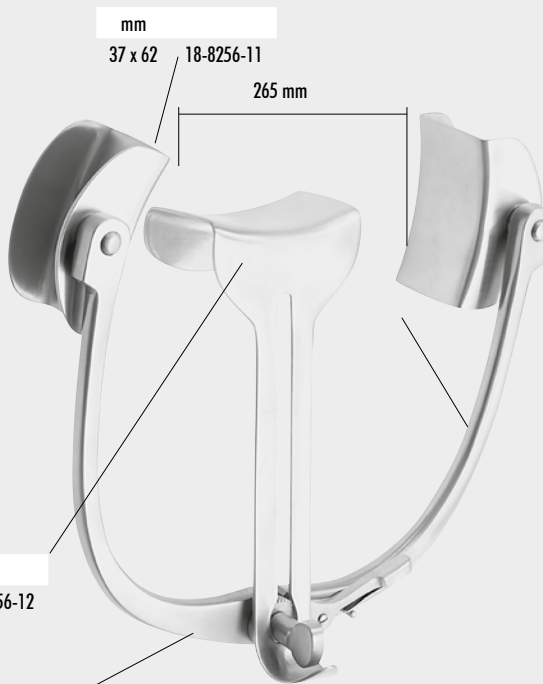

ROBIN MASSE
18-8256-00

Bestehend aus: Sperrer, 1 Paar Valven, 1 Mittelvalve
 Consisting of: Spreader, 1 pair of blades, 1 central blade
 Consistant de: Écarteur, 1 paire de valves, 1 valve centrale
 Compuesto de: Separador, 1 pareja de valvas, 1 valva central
 Composto da: Divaricatore, 1 paia di valve, 1 valva centrale

Bauchdeckenhalter
 Abdominal Retractors
 Écarteurs abdominaux
 Separadores abdominales
 Divaricatori addominali

WUNDHAKEN
WUNDSPERRER

RETRACTORS

ÉCARTEURS

SEPARADORES

DIVARICATORI



18-8256-12

18.73



Wundhakensystem, selbsthaltend
 Retractor System, Self Retaining
 Système d'écarteurs, autostatique
 Sistema de separadores autorretentivo
 Sistema di divaricatori automatico

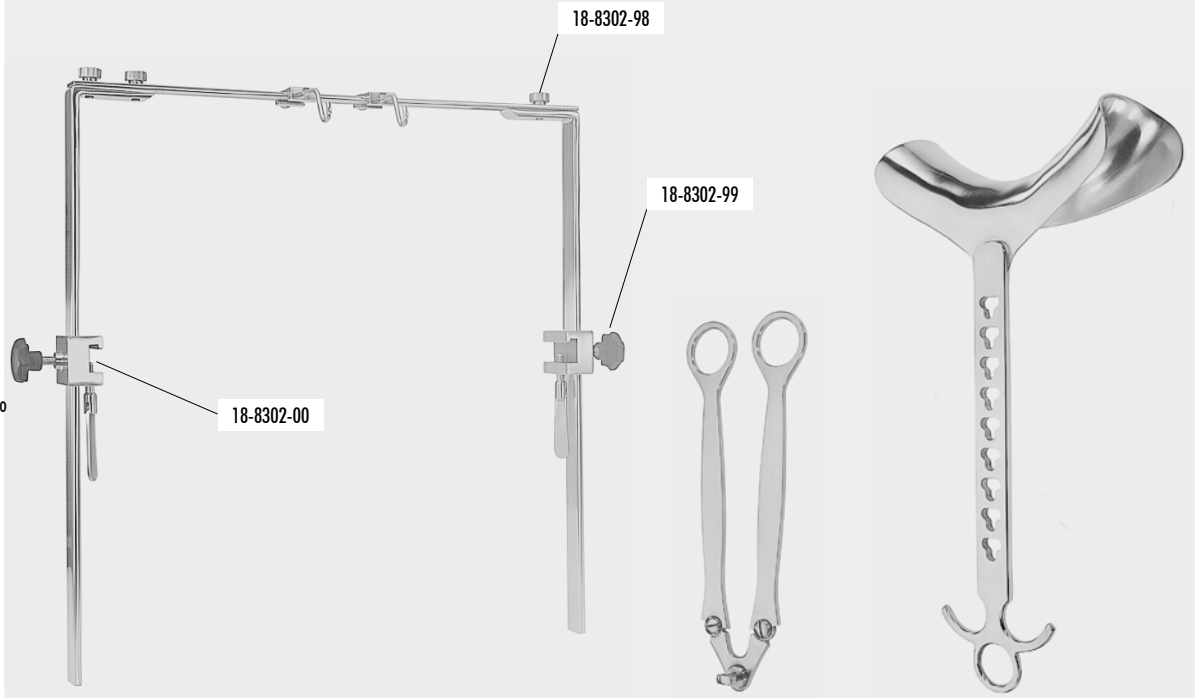

**WUNDHAKEN
 WUNDSPERRER**

RETRACTORS

ÉCARTEURS

SEPARADORES

DIVARICATORI

ROCHARD
 18-8300-01
 18-8300-02

18-8300-01 **ROCHARD**
 Rahmen einseitig
 Frame, one-sided
 Cadre un côté
 Cuadro un lado
 Telaio un lato

18-8300-02 **ROCHARD**
 Rahmen doppelt
 Frame, double
 Cadre double
 Cuadro doble
 Telaio doppio

18-8301-19

mm	
50 x 95	18-8305-09
50 x 105	18-8305-10
60 x 120	18-8306-12
60 x 135	18-8306-13
60 x 155	18-8306-15

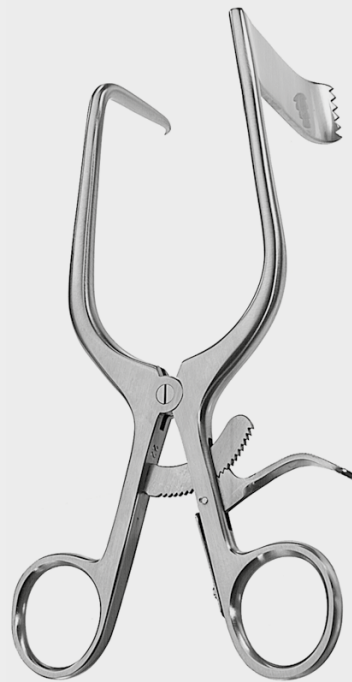

mm	» WILLIAMS «	
10 x 50	18-8801-50	18-8803-50
10 x 70	18-8801-70	18-8803-70
20 x 50	18-8802-50	18-8804-50
20 x 70	18-8802-70	18-8804-70



18-8804-70

18.74

Mikro-Bandscheibensperrer
 Microlumbar Discectomy Retractor
 Écarteur microlombaire
 Separador, discectomía lumbar
 Divaricatore, asportazione disco



cm SCOVILLE
 15,0 18-9004-00

WUNDHAKEN
 WUNDSPERRER

RETRACTORS

ÉCARTEURS

SEPARADORES

DIVARICATORI

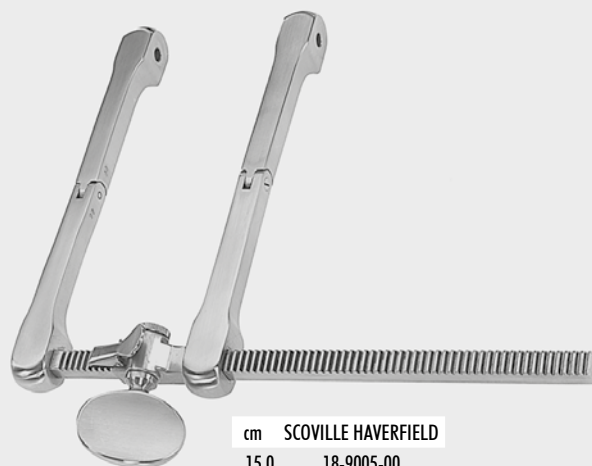

cm SCOVILLE HAVERFIELD
 15,0 18-9005-00

Hemilaminectomie-Retraktoren
 Hemilaminectomy Retractors
 Écarteurs pour hémi laminectomie
 Separadores para hemilaminectomía
 Divaricatori per emilaminectomia

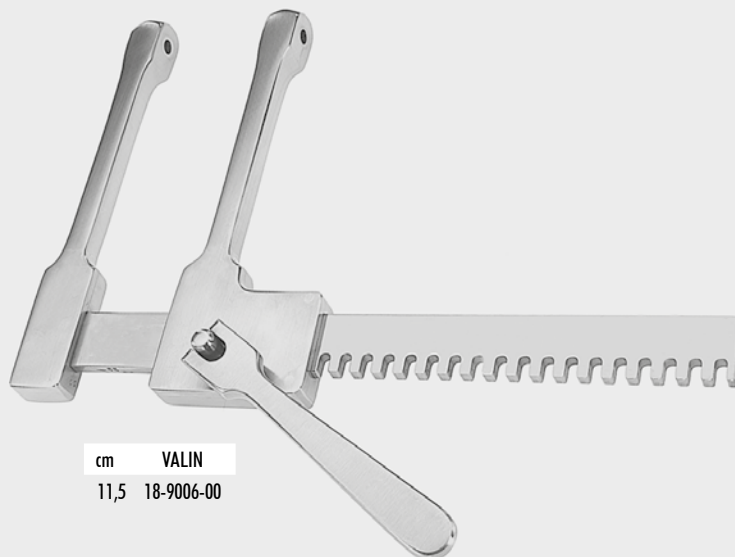

cm VALIN
 11,5 18-9006-00

ZEPF[®]

 INSTRUMENTS

18-9004-00

18.75

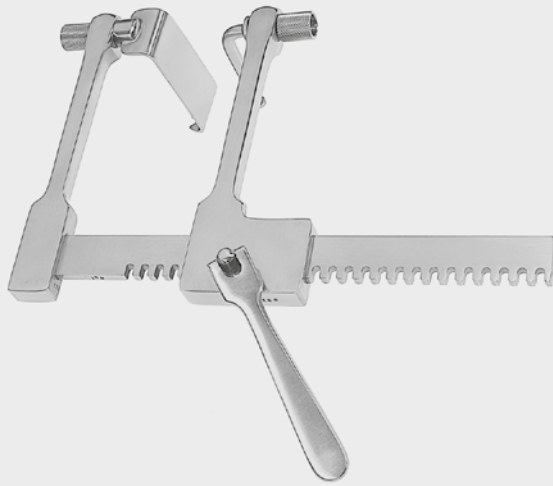

Montage-Beispiel
 Example of Assembly
 Exemple de montage
 Ejemplo de un conjunto
 Esempio di combinazione

Haken und Valven, einzeln
 Hooks and Blades, single
 Crochets et valves, seuls
 Ganchos y valvas, sueltos
 Uncini e valve, soli

**WUNDHAKEN
 WUNDSPIERRER**



mm	SCOVILLE
50	18-9006-01
70	18-9006-02
75	18-9006-03

mm	SCOVILLE
50	18-9006-06
70	18-9006-07
75	18-9006-08

mm	TAYLOR
48 x 50	18-9006-41
64 x 60	18-9006-42
64 x 64	18-9006-43
80 x 57	18-9006-44
41 x 38	18-9006-46
67 x 14	18-9006-47

mm	SCOVILLE
50 x 25	18-9007-01
50 x 50	18-9007-02
57 x 25	18-9007-03
57 x 38	18-9007-04
64 x 25	18-9007-05
64 x 29	18-9007-06
64 x 50	18-9007-07
67 x 28	18-9007-08
67 x 30	18-9007-09
75 x 25	18-9007-10
75 x 50	18-9007-11
88 x 25	18-9007-12
100 x 50	18-9007-13

RETRACTORS

ÉCARTEURS

SEPARADORES

DIVARICATORI



mm	MEYERDING
44 x 25	18-9009-44
50 x 25	18-9009-50
57 x 25	18-9009-57
70 x 25	18-9009-70
75 x 25	18-9009-75
83 x 25	18-9009-83
88 x 50	18-9009-88

mm	HIBBS
50 x 19	18-9100-01
50 x 25	18-9100-02
50 x 50	18-9100-03
64 x 25	18-9100-04
64 x 38	18-9100-05
75 x 25	18-9100-06
75 x 38	18-9100-07
75 x 50	18-9100-08
75 x 64	18-9100-09
88 x 25	18-9100-10
88 x 38	18-9100-11
100 x 25	18-9100-12
100 x 50	18-9100-13

mm	TAYLOR
75 x 32	18-9102-01
75 x 100	18-9102-02



18-9006-01

18.76

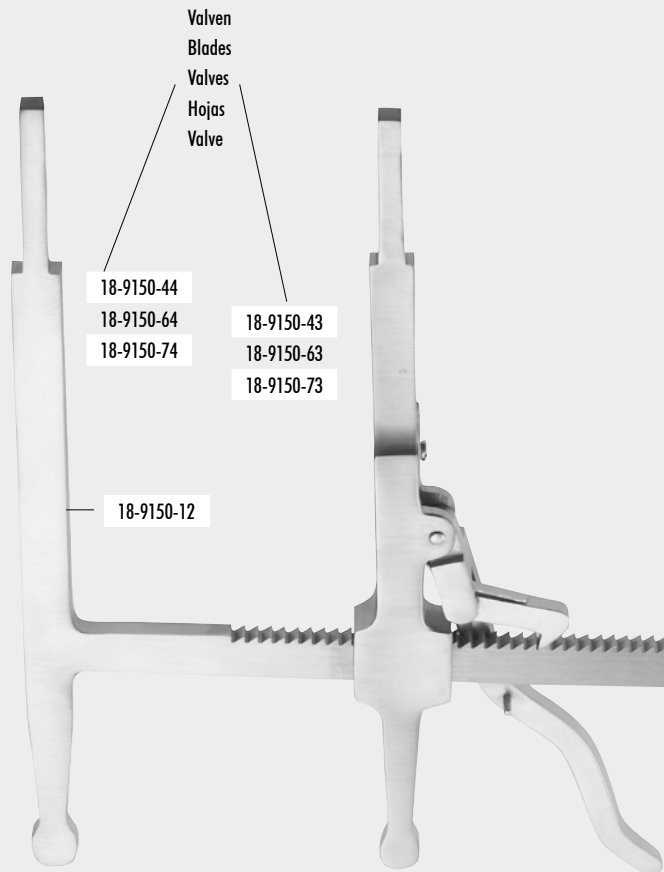

Valven
Blades
Valves
Hojas
Valve

18-9150-44

18-9150-64

18-9150-74

18-9150-43

18-9150-63

18-9150-73

18-9150-12

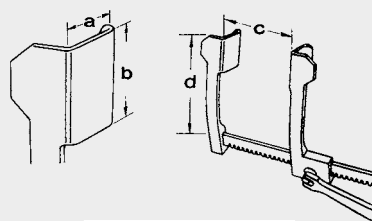

a x b mm

38 x 32 18-9150-43

38 x 42 18-9150-44

51 x 32 18-9150-63

51 x 42 18-9150-64

66 x 32 18-9150-73

66 x 42 18-9150-74

Valven
Blades
Valves
Hojas
Valve

Laminektomie-Spreizer
Laminectomy Spreader
Écarteur à laminectomie
Separador para laminectomía
Divaricatore per laminectomia

WUNDHAKEN
WUNDSPERRER

RETRACTORS

ÉCARTEURS

SEPARADORES

DIVARICATORI

GLASER

18-9150-00

komplett mit 3 Paar ineinander greifenden Valven

complete with 3 sets of intermeshing blades

complet avec 3 paires de valves

completo con 3 parejas de valvas

completo di 3 paia di valve

18-9150-12 Sperrer allein · spreader only · écarteur seul · separador suelto · divaricatore solo

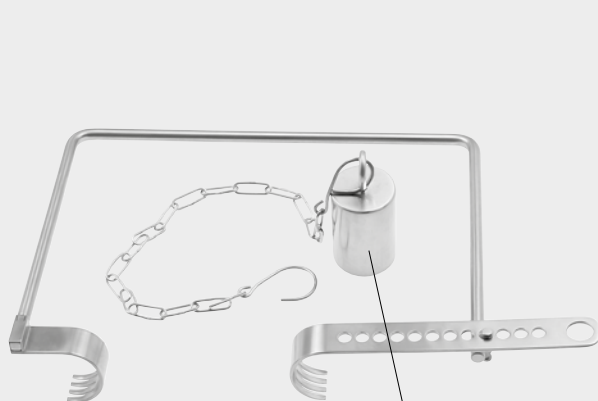

CHARNLEY compl.

18-9200-00

1,5 kg

cm

10,0 18-9902-10

Wundspreizer 31 cm Sperrweite

Retractor 31 cm spread

Écarteur, 31 cm d'écartement

Separador, abertura 31 cm

Divaricatore, apertura 31 cm



18-9903-00

Muskelhaken

Muscle Hooks

Crochets musculaires

Ganchos musculares

Uncini muscolari

ZEPF[®]
INSTRUMENTS

18-9150-00 - 18-9903-00

18.77