

THORAX

THORAX

THORAX

TÓRAX

TORACE

Distributed in New Zealand by:



Cooper Medical Limited
57 Mahunga Drive
Mangere Bridge
Auckland 2022





Rippenscheren
Rib Shears
Costotomes
Costótomos
Costotomi

THORAX

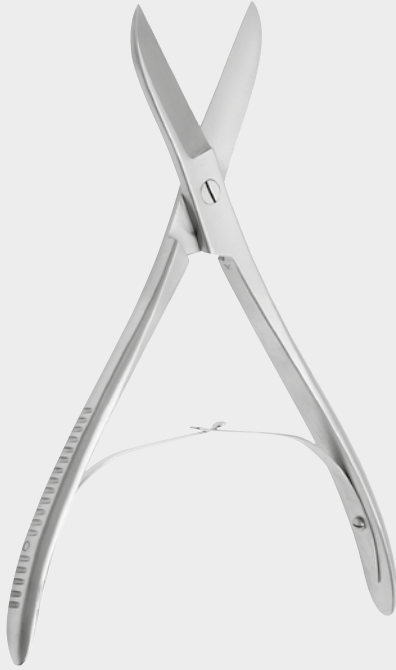

cm
23,0 56-1002-23



cm
22,0 56-1005-22



cm GLUCK
22,0 56-1007-22

THORAX

THORAX

TÓRAX

TORACE



cm COLLIN
19,5 56-1011-19



cm STILLE
21,0 56-1101-21



cm CORYLLOS »
35,0 56-1203-35



cm CORYLLOS «
35,0 56-1205-35



cm BETHUNE
34,0 56-1206-34



56-1002-23

56.2

Rippenscheren
Rib Shears
Costotomes
Costótomos
Costotomi



cm COOLEY
35,0 56-1208-35



cm SAUERBRUCH BRITSCH
30,0 56-1305-30

mit 2 Schneide Köpfen
with 2 chutter heads
avec 2 têtes de coupe
con 2 cabezales de corte
con 2 teste di taglia

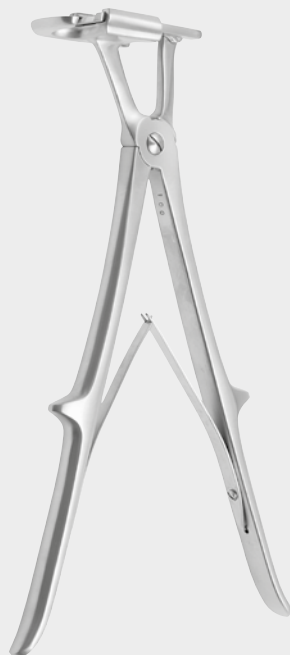

cm SAUERBRUCH
24,0 56-1301-24
26,0 56-1301-26



cm GIERTZ-STILLE
27,0 56-1307-27

THORAX

THORAX

THORAX

TÓRAX

TORACE



cm SAUERBRUCH-FREY
36,0 56-1401-36



cm BRUNNER
32,0 56-1407-32 »
33,0 56-1407-33 «



cm SCHUMACHER
21,0 56-1408-21

für Sternum
for sternum
pour le sternum
para el esternón
per lo sterno



56-1408-21

56.3



Rippensperrer
 Rib Spreaders
 Écarteurs des côtes
 Separadores costales
 Divaricatori costali

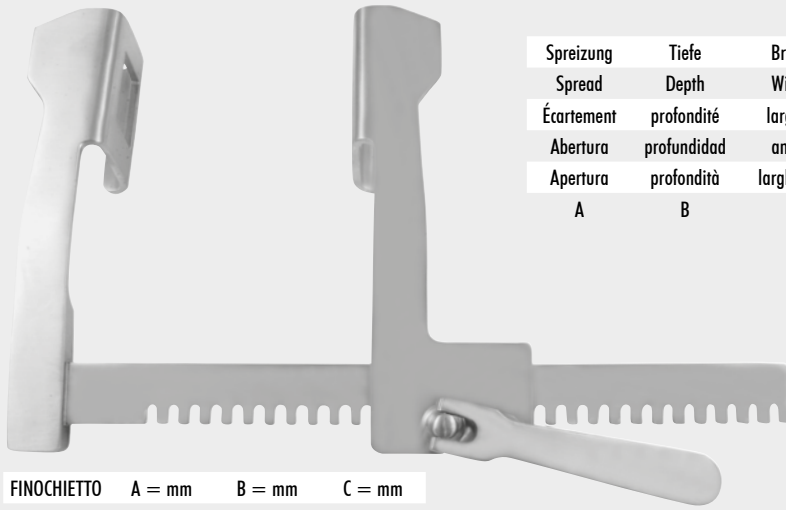

Spreizung	Tiefe	Breite
Spread	Depth	Width
Écartement	profondité	largeur
Abertura	profundidad	ancho
Apertura	profondità	larghezza
A	B	C

FINOCHIETTO	A = mm	B = mm	C = mm
56-2100-16	165	40	40
56-2100-20	200	45	65
56-2100-25	250	70	65
56-2100-30	300	70	65

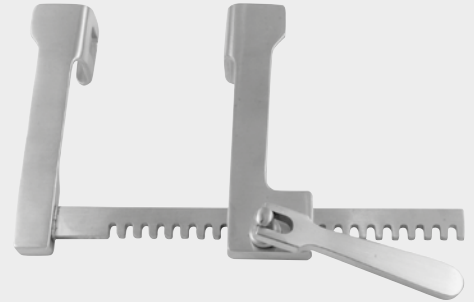

FINOCHIETTO-Baby	A = mm	B = mm	C = mm
56-2104-75	75	18	20

THORAX

THORAX

THORAX

TÓRAX

TORACE

Aus Aluminium - from Aluminium -
 en aluminium - de aluminio - in alluminio

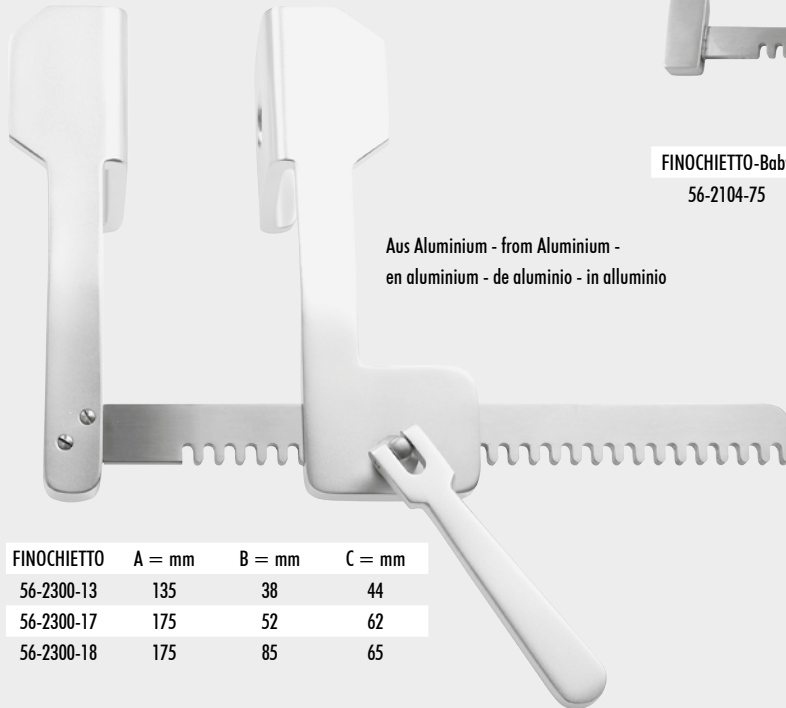

FINOCHIETTO	A = mm	B = mm	C = mm
56-2300-13	135	38	44
56-2300-17	175	52	62
56-2300-18	175	85	65

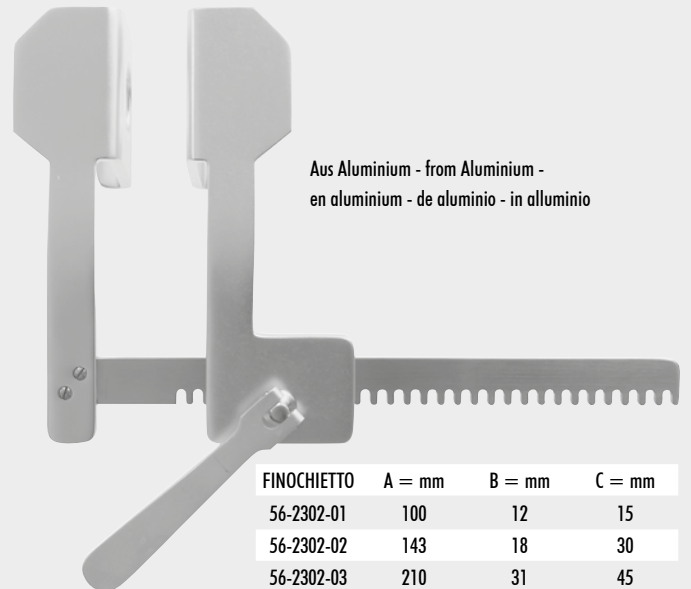

Aus Aluminium - from Aluminium -
 en aluminium - de aluminio - in alluminio

FINOCHIETTO	A = mm	B = mm	C = mm
56-2302-01	100	12	15
56-2302-02	143	18	30
56-2302-03	210	31	45
56-2302-04	245	42	61



56-2100-16

56.4



Aus Aluminium - from Aluminium -
en aluminium - de aluminio - in alluminio

FINOCHIETTO-Infant	A = mm	B = mm	C = mm
56-2304-75	75	15	15

Spreizung	Tiefe	Breite
Spread	Depth	Width
Écartement	profondité	largeur
Abertura	profundidad	ancho
Apertura	profondità	larghezza
A	B	C

70 x 65 mm

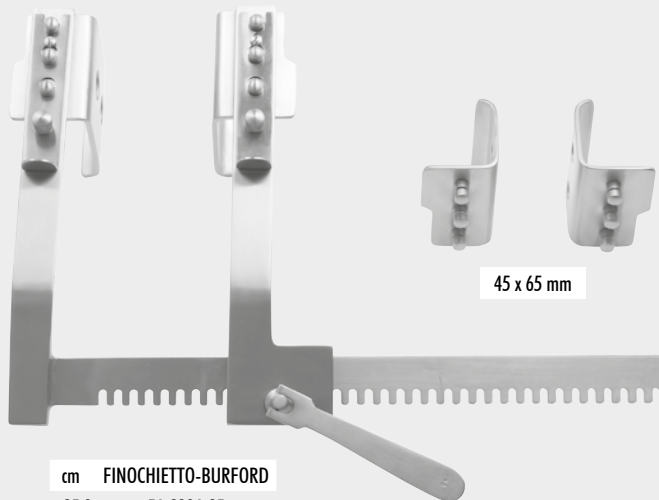

cm **FINOCHIETTO-BURFORD**
25,0 56-2306-25

45 x 65 mm

Rippensperrer
Rib Spreaders
Écarteurs des côtes
Separadores costales
Divaricatori costali



FINOCHIETTO-Baby	A = mm	B = mm	C = mm
56-2305-10	100	31	31

Aus Aluminium - from Aluminium -
en aluminium - de aluminio - in alluminio

THORAX

THORAX

THORAX

Aus Aluminium - from Aluminium -
en aluminium - de aluminio - in alluminio

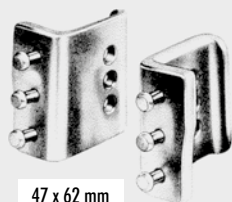

47 x 62 mm

Aus Aluminium - from Aluminium -
en aluminium - de aluminio - in alluminio

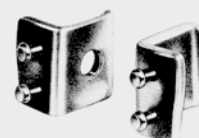

34 x 42 mm



65 x 62 mm

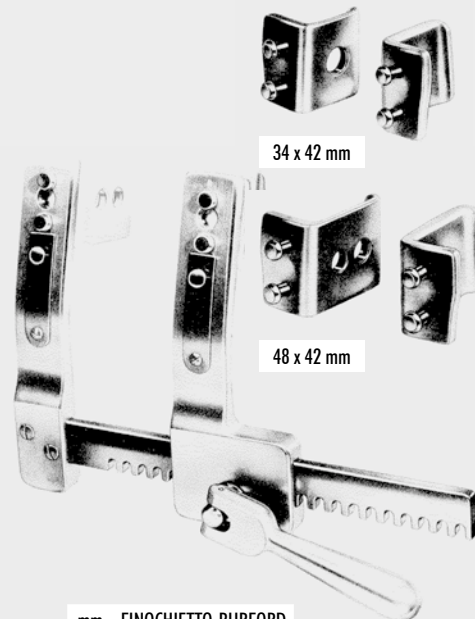

48 x 42 mm

mm **FINOCHIETTO-BURFORD**
135 56-2404-13

TÓRAX

TORACE

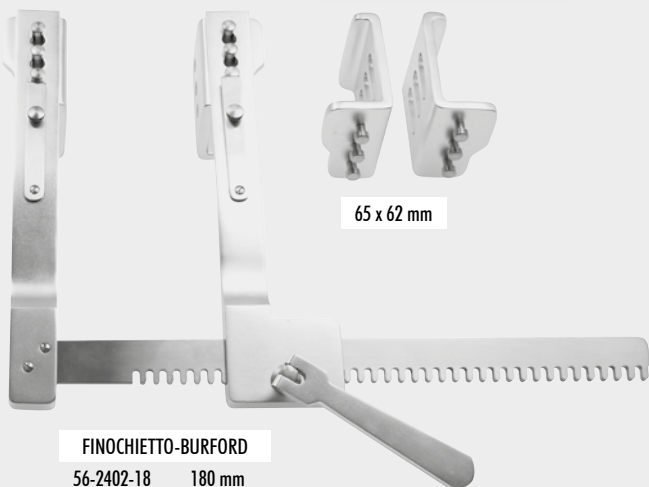

FINOCHIETTO-BURFORD	
56-2402-18	180 mm
56-2402-26	260 mm
56-2402-30	300 mm

Für Erwachsene - Adult Size - pour adultes -
para adultos - per adulti

Für Kinder - Child Size - pour enfants -
para niños - per bambini



56-2404-13

56.5

Aus Aluminium - from Aluminium -
en aluminium - de aluminio - in alluminio

Spreizung	Tiefe	Breite
Spread	Depth	Width
Écartement	profondité	largeur
Abertura	profundidad	ancho
Apertura	profondità	larghezza
A	B	C

COOLEY	A = mm	B = mm	C = mm
56-2480-01	95	12	16
56-2480-02	140	15	30
56-2480-03	150	21	44
56-2480-04	200	35	50

Rippensperrer
Rib Spreaders
Écarteurs des côtes
Separadores costales
Divaricatori costali



Aus Aluminium - from Aluminium -
en aluminium - de aluminio - in alluminio

THORAX

THORAX

COOLEY	A = mm	B = mm	C = mm
56-2484-14	145	21	45
56-2484-19	190	32	50



Aus Aluminium - from Aluminium -
en aluminium - de aluminio - in alluminio

THORAX

TÓRAX

TORACE

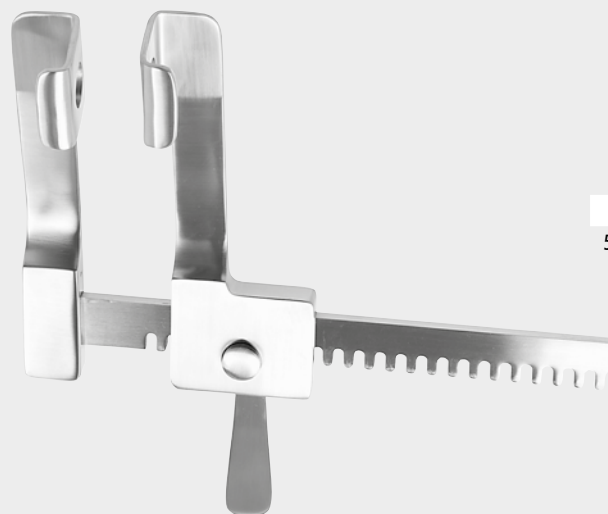

COOLEY	A = mm	B = mm	C = mm
56-2496-12	120	25	32

ZEPF[®]
α
INSTRUMENTS

56-2480-01

56.6

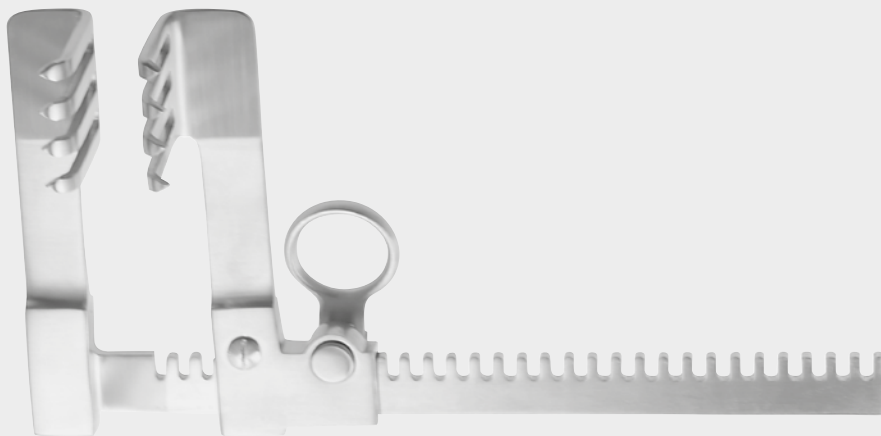

HARRIS	A = mm	B = mm	C = mm
56-2598-16	160	35	51

CASTAÑEDA	A = mm	B = mm	C = mm
56-2500-06	65	10,5	32
56-2500-07	70	12	45
56-2500-12	120	15	60

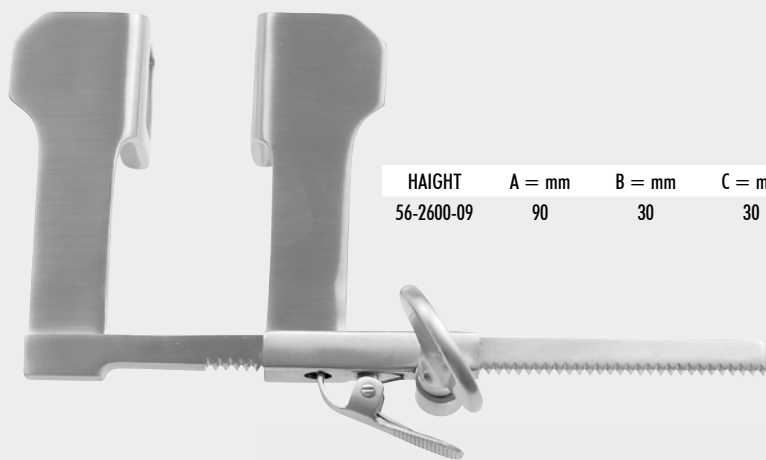
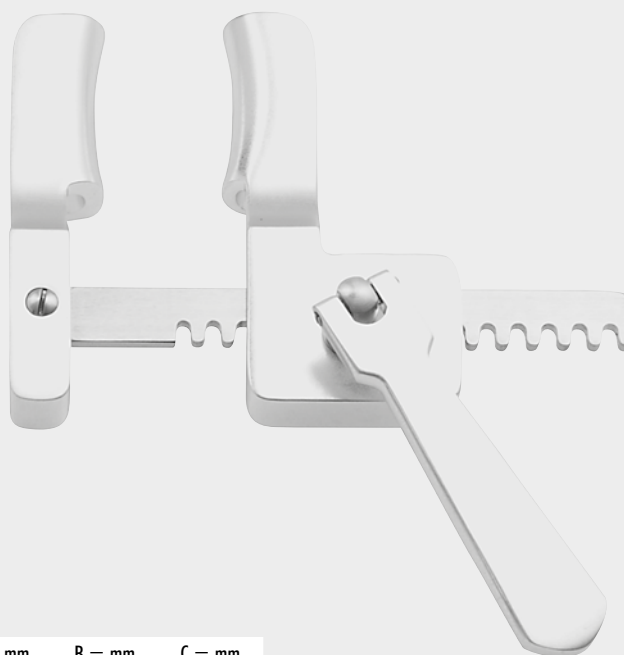

HAIGHT	A = mm	B = mm	C = mm
56-2600-09	90	30	30

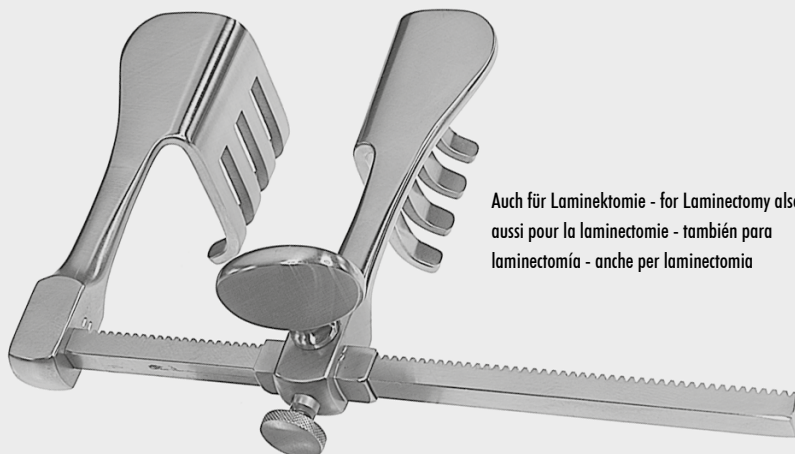

BADGLEY	A = mm	B = mm	C = mm
56-2602-16	162	51	44

Auch für Laminectomie - for Laminectomy also -
aussi pour la laminectomie - también para
laminectomía - anche per laminectomia

Rippensperrer
Rib Spreaders
Écarteurs des côtes
Separadores costales
Divaricatori costali

THORAX

THORAX

THORAX

TÓRAX

TORACE

Rippensperrer
Rib Spreaders
Écarteurs des côtes
Separadores costales
Divaricatori costali



Spreizung	Tiefe	Breite
Spread	Depth	Width
Écartement	profondité	largeur
Abertura	profundidad	ancho
Apertura	profondità	larghezza
A	B	C

TUFFIER	A = mm	B = mm	C = mm
56-2604-16	165	50	45

THORAX

THORAX

THORAX

TÓRAX

TORACE

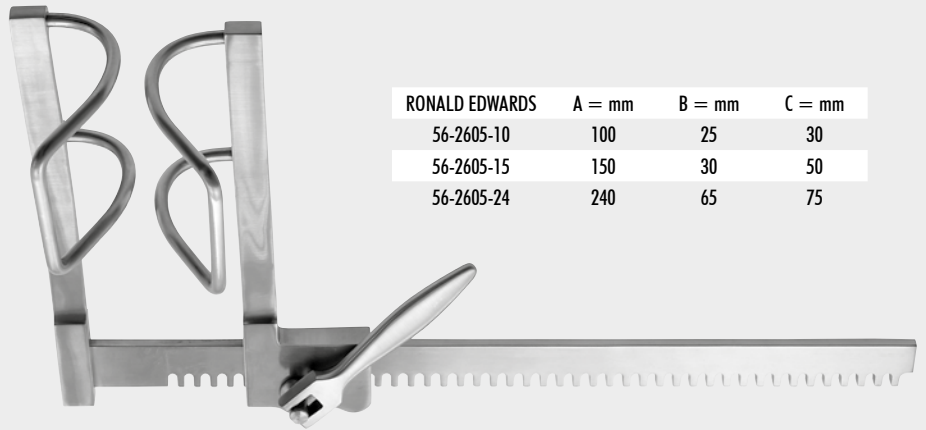

RONALD EDWARDS	A = mm	B = mm	C = mm
56-2605-10	100	25	30
56-2605-15	150	30	50
56-2605-24	240	65	75



Valven allein, Paar:
Blades only, by pairs:
Valves seules, la paire:
Valvas sueltas, la pareja:
Valve sole, la coppia:

56-2606-30	30 mm x 30 mm *	* Tiefe x Breite
56-2606-40	40 mm x 40 mm *	depth x width
56-2606-50	50 mm x 50 mm *	profondeur x largeur
56-2608-40	40 mm x 100 mm *	profundidad x ancho
56-2608-50	50 mm x 80 mm *	profondità x largo
56-2608-60	60 mm x 60 mm *	
56-2608-66	50 mm x 66 mm f. Sternotomie, f. sternotomy, pour la sternotomie, p. esternotomía, p. sternotomia	
56-2608-80	80 mm x 60 mm *	

Sperrer allein, Spreaders only, Ecarteurs seuls,
Separadores sueltos, Divaricatori soli:

56-2606-22	22 cm
56-2608-28	28 cm

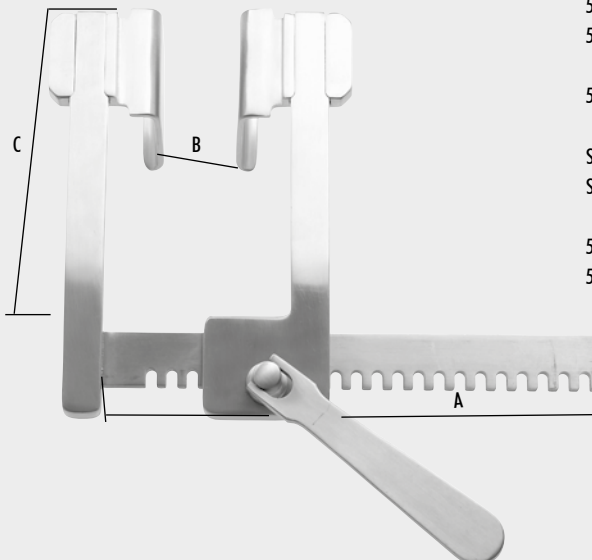

DE BAKLEY	A = mm	B = mm	C = mm
56-2606-00	220	150	180
56-2608-00	285	200	225

cm	DE BAKLEY, compl.:
22,0	56-2606-00 = incl. 56-2606-22, 56-2606-30, 56-2606-40, 56-2606-50
28,0	56-2608-00 = incl. 56-2608-28, 56-2608-40, 56-2608-50, 56-2608-60

ZEPF[®]
α
INSTRUMENTS

56-2604-16

56.8

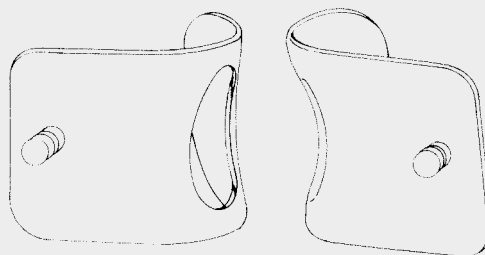
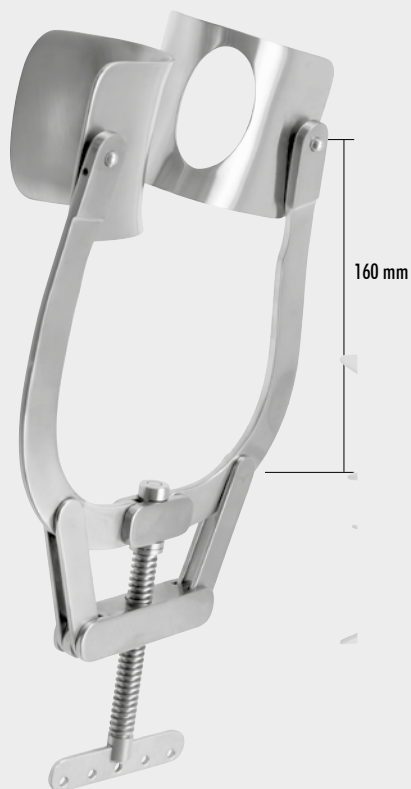

75 x 75 mm

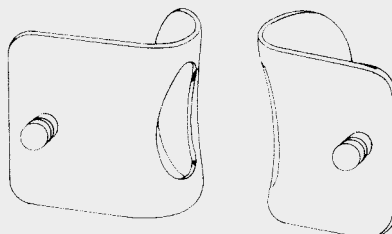

42 x 65 mm

MERCEDES compl. mit 2 Paar Valven - with 2 pairs of blades -
56-2700-00 avec 2 paires de valves - con 2 parejas de valvas -
con 2 paia di valve

Rippensperrer
Rib Spreaders
Écarteurs des côtes
Separadores costales
Divaricatori costali

THORAX

THORAX

THORAX

TÓRAX

TORACE

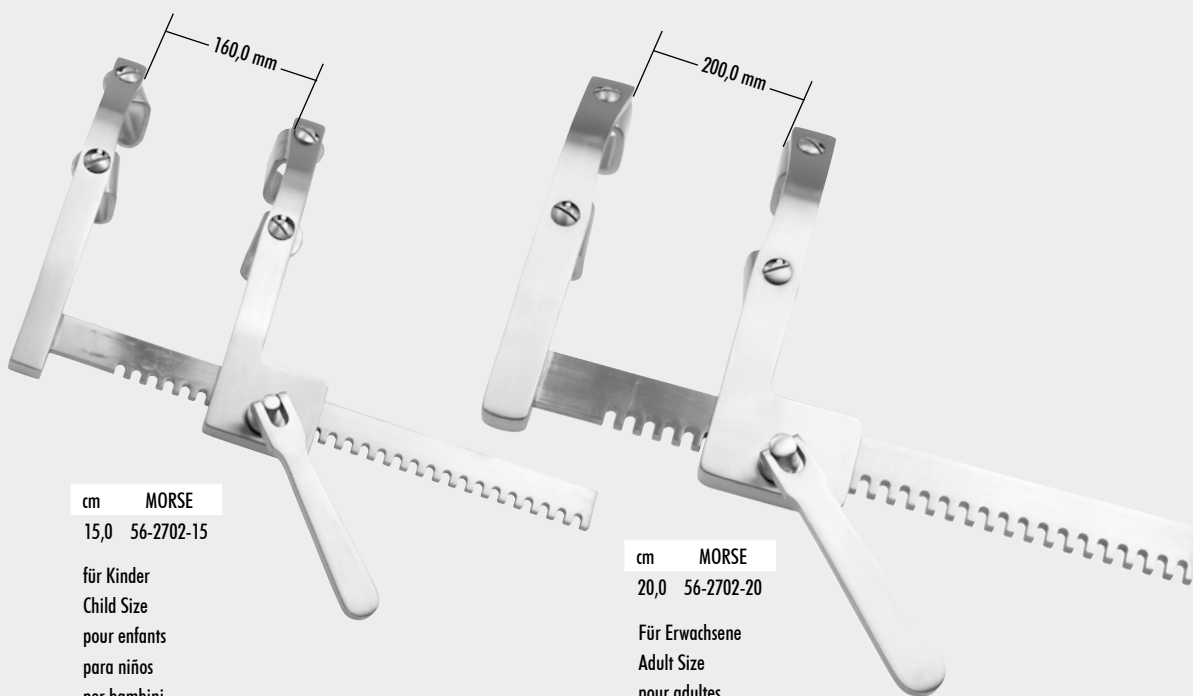

cm MORSE
15,0 56-2702-15

für Kinder
Child Size
pour enfants
para niños
per bambini

cm MORSE
20,0 56-2702-20

Für Erwachsene
Adult Size
pour adultes
para adultos
per adulti

ZEPF®
INSTRUMENTS

56-2702-20

56.9

Rippensperrer
Rib Spreaders
Écarteurs des côtes
Separadores costales
Divaricatori costali

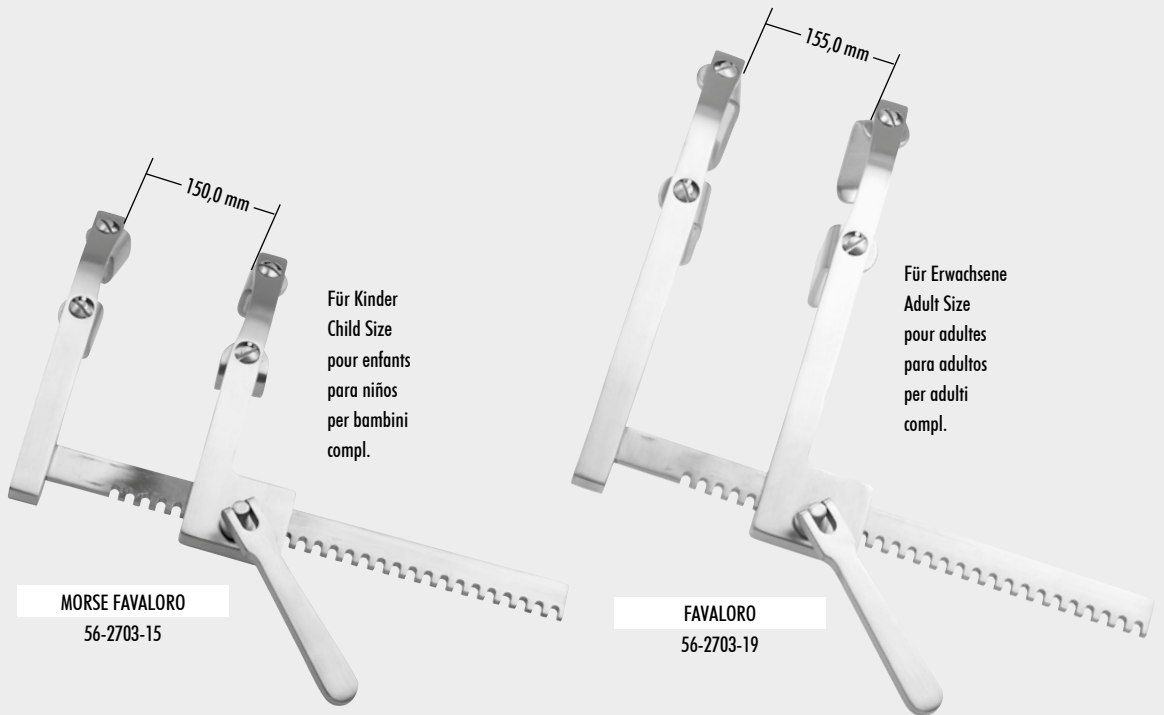

Für Kinder
Child Size
pour enfants
para niños
per bambini
compl.

Für Erwachsene
Adult Size
pour adultes
para adultos
per adulti
compl.

MORSE FAVALORO
56-2703-15

FAVALORO
56-2703-19

THORAX

THORAX

THORAX

TÓRAX

TORACE

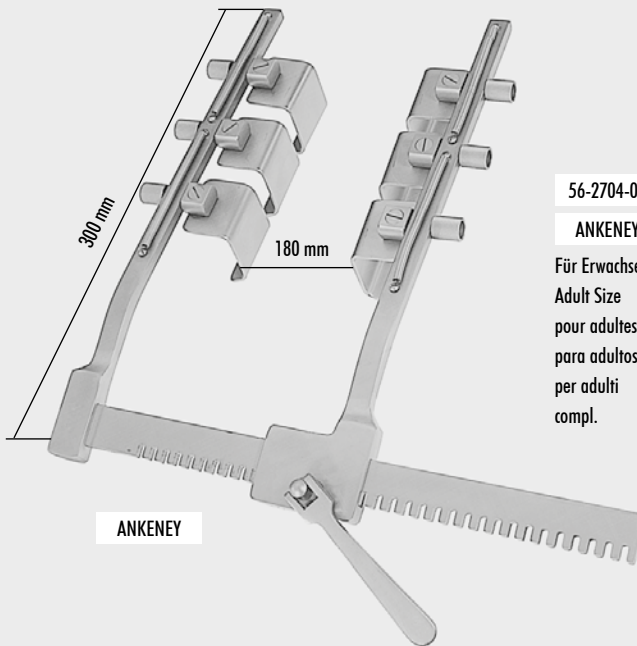

56-2704-00
ANKENEY

Für Erwachsene
Adult Size
pour adultes
para adultos
per adulti
compl.

mit 6 abnehmbaren Valven
with 6 detachable blades
avec 6 valves démontables
con 6 valvas desmontables
con 6 valve smontabili

56-2704-01

ANKENEY 35 x 32 mm

Satz von 6 Valven allein
Set of 6 blades only
Jeu de 6 valves seules
Juego de 6 valvas sueltas
Set di 6 valve sole

ANKENEY

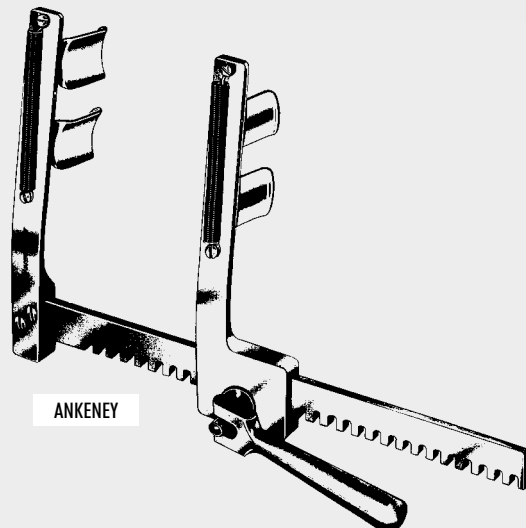

ANKENEY

56-2707-00

Aus Aluminium - from Aluminium -
en aluminium - de aluminio - in alluminio

Für Kinder
Child Size
pour enfants
para niños
per bambini
compl.

mit 4 festen Valven
with 4 fixed blades
avec 4 valves fixes
con 4 valvas fijas
con 4 valve fisse

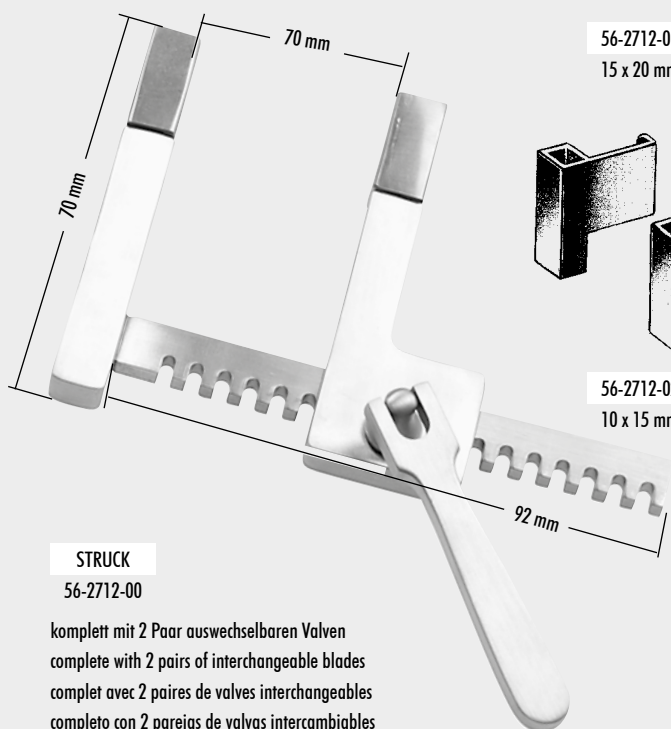

STRUCK
56-2712-00

komplett mit 2 Paar auswechselbaren Valven
complete with 2 pairs of interchangeable blades
complet avec 2 paires de valves interchangeables
completo con 2 parejas de valvas intercambiables
completo di 2 coppie di valve intercambiabili

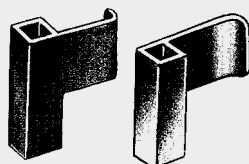

56-2712-01
15 x 20 mm

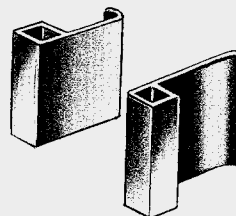

56-2712-03
10 x 20 mm

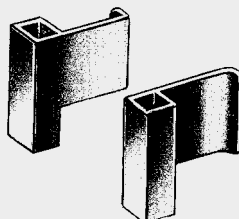

56-2712-02
10 x 15 mm

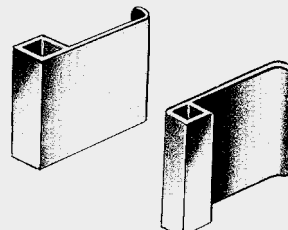

56-2712-04
20 x 20 mm

Rippensperrer
Rib Spreaders
Écarteurs des côtes
Separadores costales
Divaricatori costali

THORAX

THORAX

THORAX

TÓRAX

TORACE

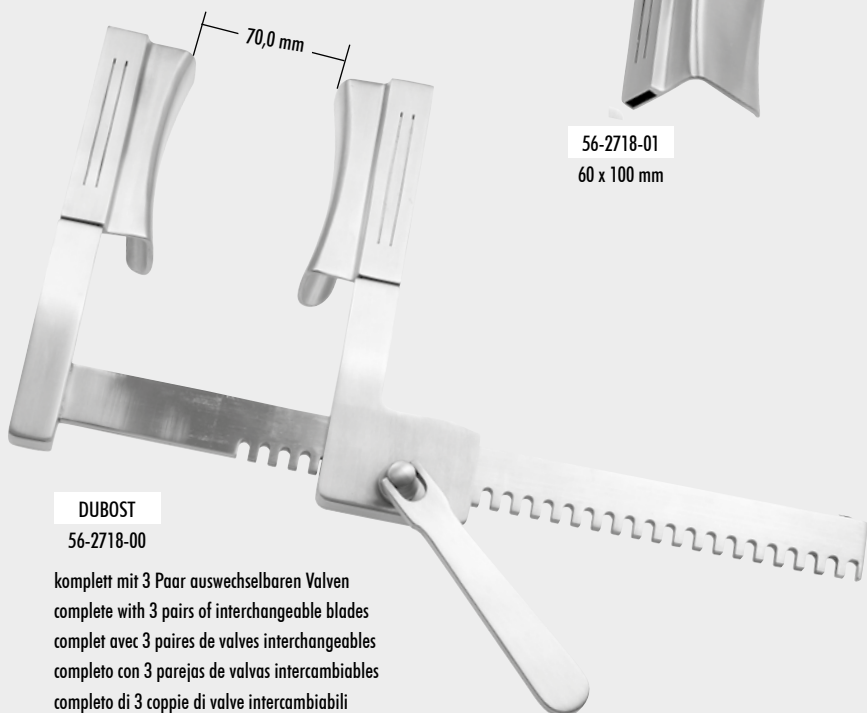

DUBOST
56-2718-00

komplett mit 3 Paar auswechselbaren Valven
complete with 3 pairs of interchangeable blades
complet avec 3 paires de valves interchangeables
completo con 3 parejas de valvas intercambiables
completo di 3 coppie di valve intercambiabili



56-2718-01
60 x 100 mm



56-2718-02
50 x 100 mm



56-2718-03
40 x 100 mm



56-2718-03

56.11

Rippensperrer
Rib Spreaders
Écarteurs des côtes
Separadores costales
Divaricatori costali

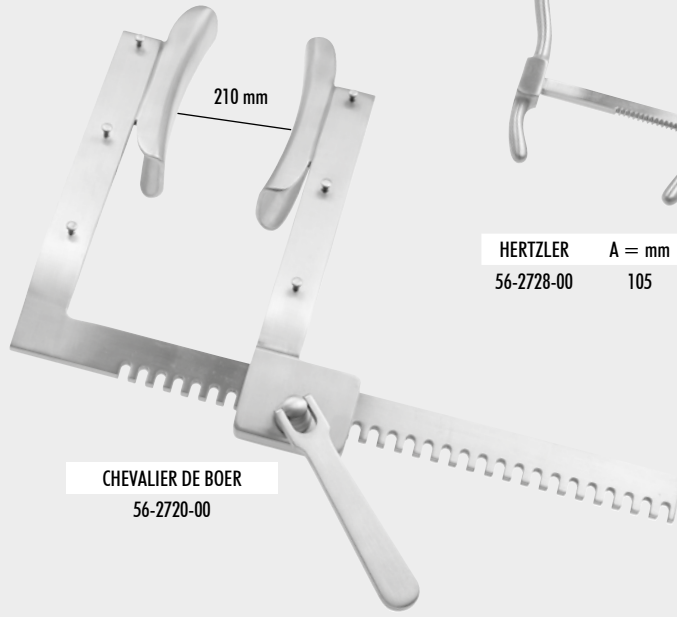

CHEVALIER DE BOER
56-2720-00

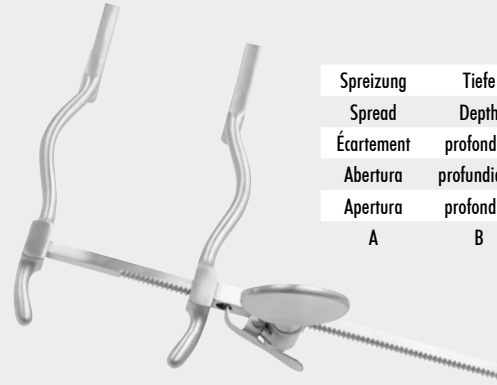

HERTZLER	A = mm	B = mm	C = mm
56-2728-00	105	25	25

Spreizung	Tiefe	Breite
Spread	Depth	Width
Écartement	profondité	largeur
Abertura	profundidad	ancho
Apertura	profondità	larghezza
A	B	C

THORAX

THORAX

THORAX

TÓRAX

TORACE

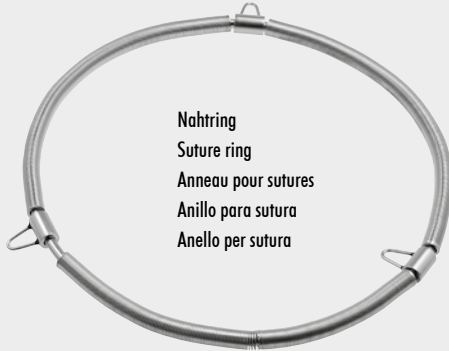

Nähring
Suture ring
Anneau pour sutures
Anillo para sutura
Anello per sutura

ø mm	CRAWFORD
23,0 cm	56-2740-23



mm x mm	COOLEY 24,0 cm »
45 x 48	56-2760-01



mm x mm	COOLEY 24,5 cm »	
45 x 48	56-2760-02	

Atriumhaken
Atrium Retractors
Écarteurs pour l'atrium
Separadores para el atrio
Divaricatori per il atrio



mm x mm	COOLEY 25,5 cm «
25 x 46	56-2760-03



mm x mm	COOLEY STRUCK 24,0 cm
30 x 45	56-2762-01

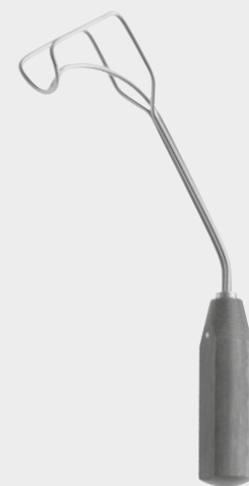

mm x mm	COOLEY STRUCK 24,0 cm	
45 x 35	56-2762-02	



56-2720-00

56.12



mm x mm COOLEY 21,0 cm
 14 x 17 / 14 x 45 56-2790-01
 14 x 21 / 14 x 45 56-2790-02



mm x mm CRAWFORD 19,0 cm
 15 x 15 56-2792-15
 15 x 23 56-2792-23

Atriumhaken
 Atrium Retractors
 Écarteurs pour l'atrium
 Separadores para el atrio
 Divaricatori per il atrio

THORAX

THORAX

THORAX

TÓRAX

TORACE

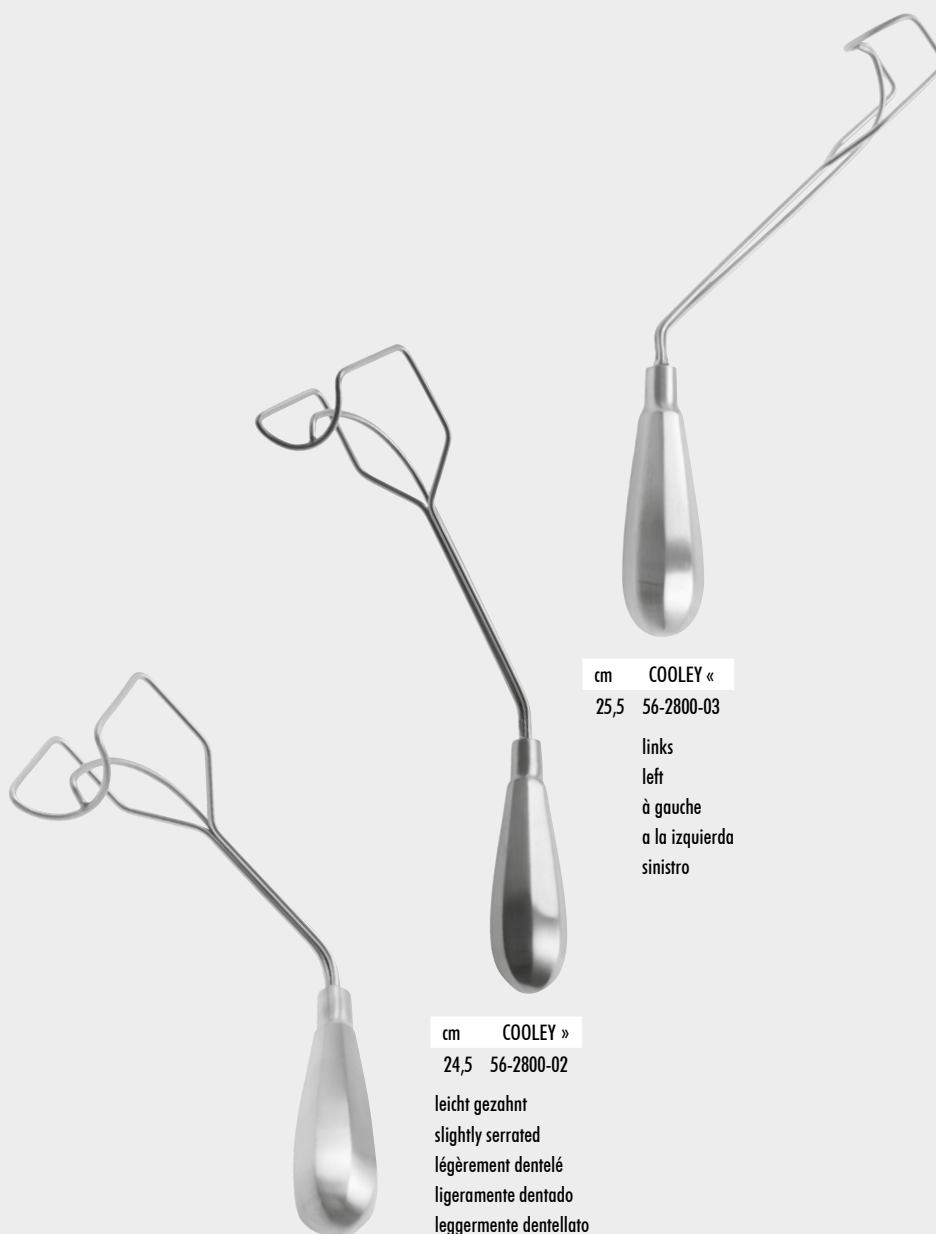

cm COOLEY «
 25,5 56-2800-03

links
 left
 à gauche
 a la izquierda
 sinistro

cm COOLEY »
 24,5 56-2800-02

leicht gezahnt
 slightly serrated
 légèrement dentelé
 ligeramente dentado
 leggermente dentellato

COOLEY
 56-2800-01 - 56-2800-03

cm COOLEY »
 24,5 56-2800-01



56-2800-03

56.13

Rippen-Konraktoren
 Rib Approximators
 Approximateurs de côtes
 Aproximadores de costillas
 Avvicinatori costali

THORAX



cm SELLORS
 19,0 56-2800-19



cm BAILEY Baby
 14,0 56-2802-14



cm BAILEY
 16,0 56-2804-16



cm BAILEY GIBBON
 16,0 56-2806-16

THORAX

THORAX

TÓRAX

TORACE



cm LEMMON
 14,0 56-2808-14
 18,0 56-2808-18

Sternum-Approximator
 Sternal Approximator
 Approximateur sternal
 Aproximador esternal
 Avvicinatore sternale

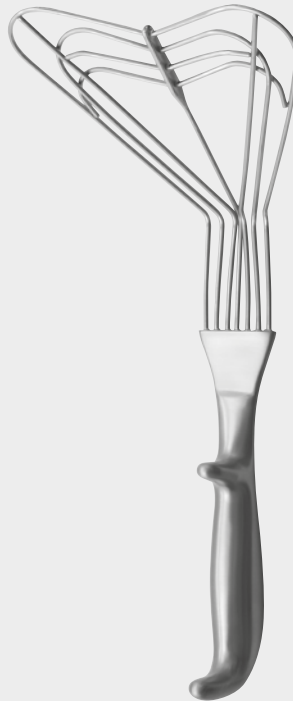

cm
 26,0 56-2809-26

Lungenspatel
 Lung Spatula
 Spatule pulmonaire
 Espátula pulmonar
 Spatola polmonare



cm ALLISON
 30,0 56-2809-30
 32,0 56-2809-32



56-2800-19

56.14



flexibler Schaft
flexible shaft
tige flexible
vástago flexible
asta flessibile

ROSS Aorta
56-2810-01 - 56-2810-06



mm
12 x 15 56-2810-01



mm
18 x 18 56-2810-02



mm
18 x 22 56-2810-03

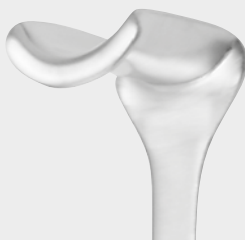

mm
25 x 26 56-2810-04



mm
25 x 35 56-2810-05



mm
25 x 20 56-2810-06



Lungen-Fasszangen
Lung Grasping Forceps
Pincès à saisir le poumon
Pinzas para coger el pulmón
Pinze per afferrare il polmone



cm **LOVELACE**
20,0 56-2900-20

cm **LOVELACE**
20,0 56-2901-20



mm x mm	BOROWSKI 27,0 cm
17 x 21	56-2812-01
16 x 23	56-2812-02
20 x 25	56-2812-03
24 x 27	56-2812-04
28 x 20	56-2812-05
28 x 29	56-2812-06



cm **HARRINGTON**
30,5 56-3001-30

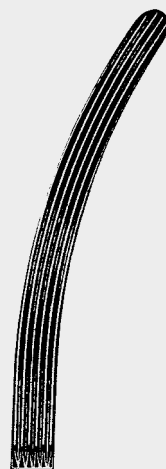

cm **HARRINGTON**
29,5 56-3003-29

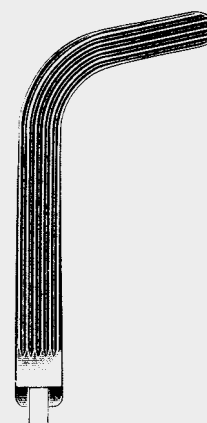

Aorta-Haken
Aortic Retractors
Écarteurs pour l'aorte
Separadores para la aorta
Divaricatori per l'aorta

THORAX

THORAX

THORAX

TÓRAX

TORACE

Bronchus-Klemmen
Bronchus Forceps
Pincès Clamps pour les bronches
Pinzas Clamps bronquiales
Pinze per bronchi



56-3003-29

56.15



Bronchus-Klemmen
 Bronchus Forceps
 Pinces Clamps pour les bronches
 Pinzas Clamps bronquiales
 Pinze per bronchi

THORAX

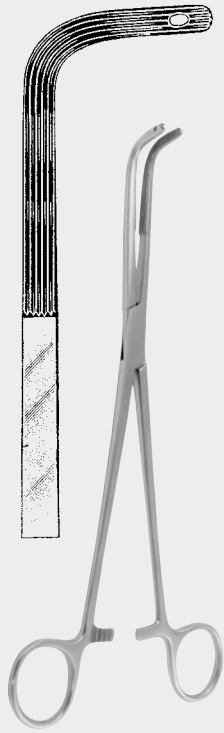

cm FINOCHIETTO
 24,0 56-3007-24

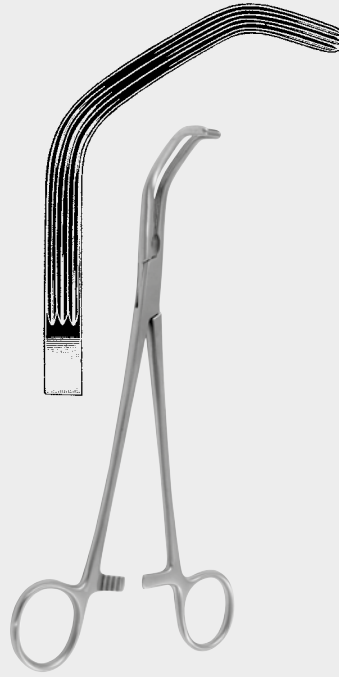

cm PRICE-THOMAS
 22,0 56-3009-22



PRICE-THOMAS
 56-3101-22 22,0 cm 56-3103-22

Zahn links	Zahn rechts
Tooth left side	Tooth right side
Dents à gauche	Dents à droite
Diente a la izquierda	Diente a la derecha
Dente sinistro	Dente destro

THORAX

THORAX

TÓRAX

TORACE



SAROT
 56-3107-23 23,0 cm 56-3109-23

Zahn links	Zahn rechts
Tooth left side	Tooth right side
Dents à gauche	Dents à droite
Diente a la izquierda	Diente a la derecha
Dente sinistro	Dente destro

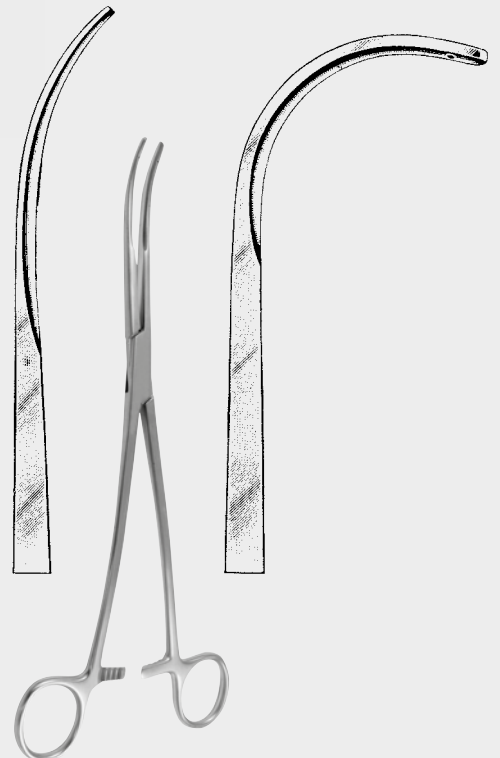

SEMB
 56-3201-23 23,0 cm 56-3203-23



56-3007-24

56.16

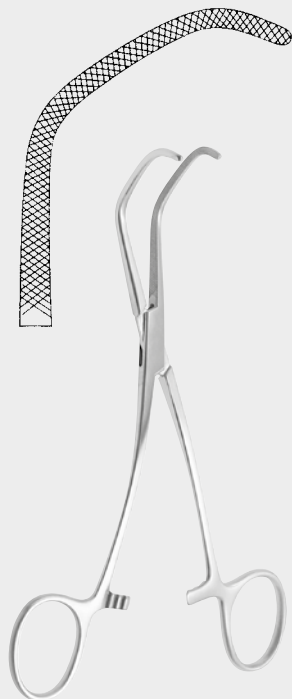

cm SATINSKY
15,0 56-3205-15



cm SATINSKY
26,0 56-3207-26 - 56-3209-26

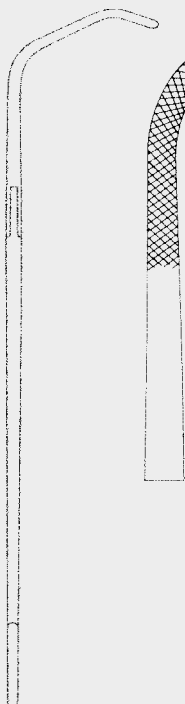

56-3301-26
Fig. 1

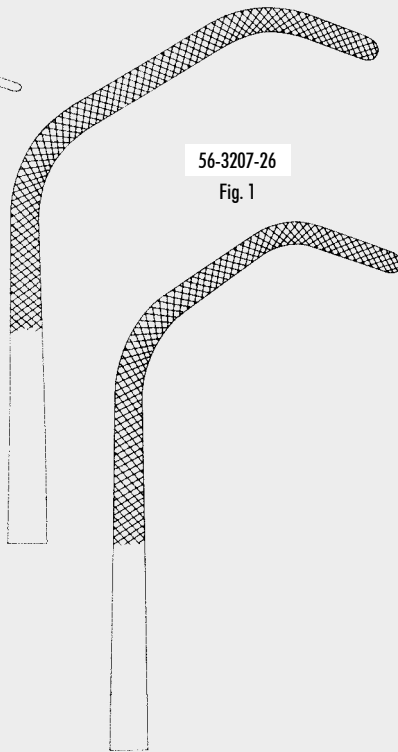

56-3303-26
Fig. 2



cm SATINSKY
26,5 56-3301-26 - 56-3303-26

56-3209-26
Fig. 2

56-3207-26
Fig. 1

Anastomosens-Klemmen
Anastomosis Clamps
Pinces à anastomose
Pinzas para anastomosis
Pinze per anastomosi

THORAX

THORAX

THORAX

TÓRAX

TORACE



56-3303-26

56.17



Gefäßklemmen
Vascular Forceps
Pincers vasculaires
Pinzas vasculares
Pinze vascolari

THORAX

THORAX

THORAX

TÓRAX

TORACE

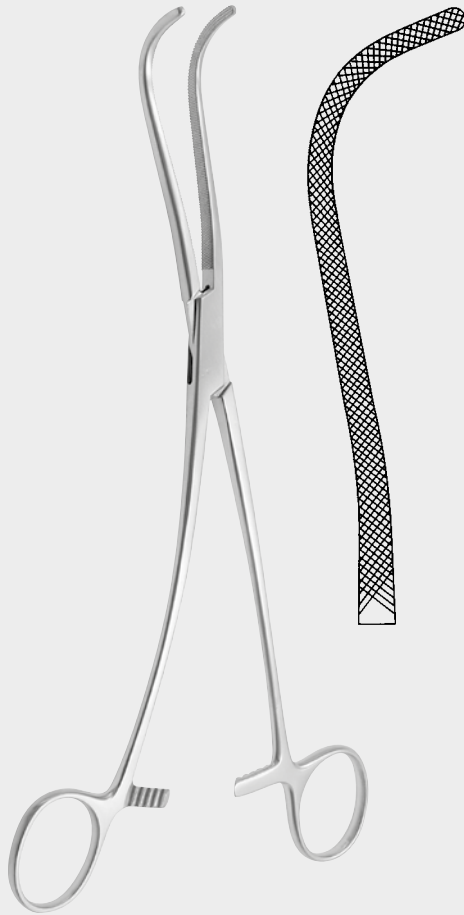

cm HARKEN
24,0 56-3403-24

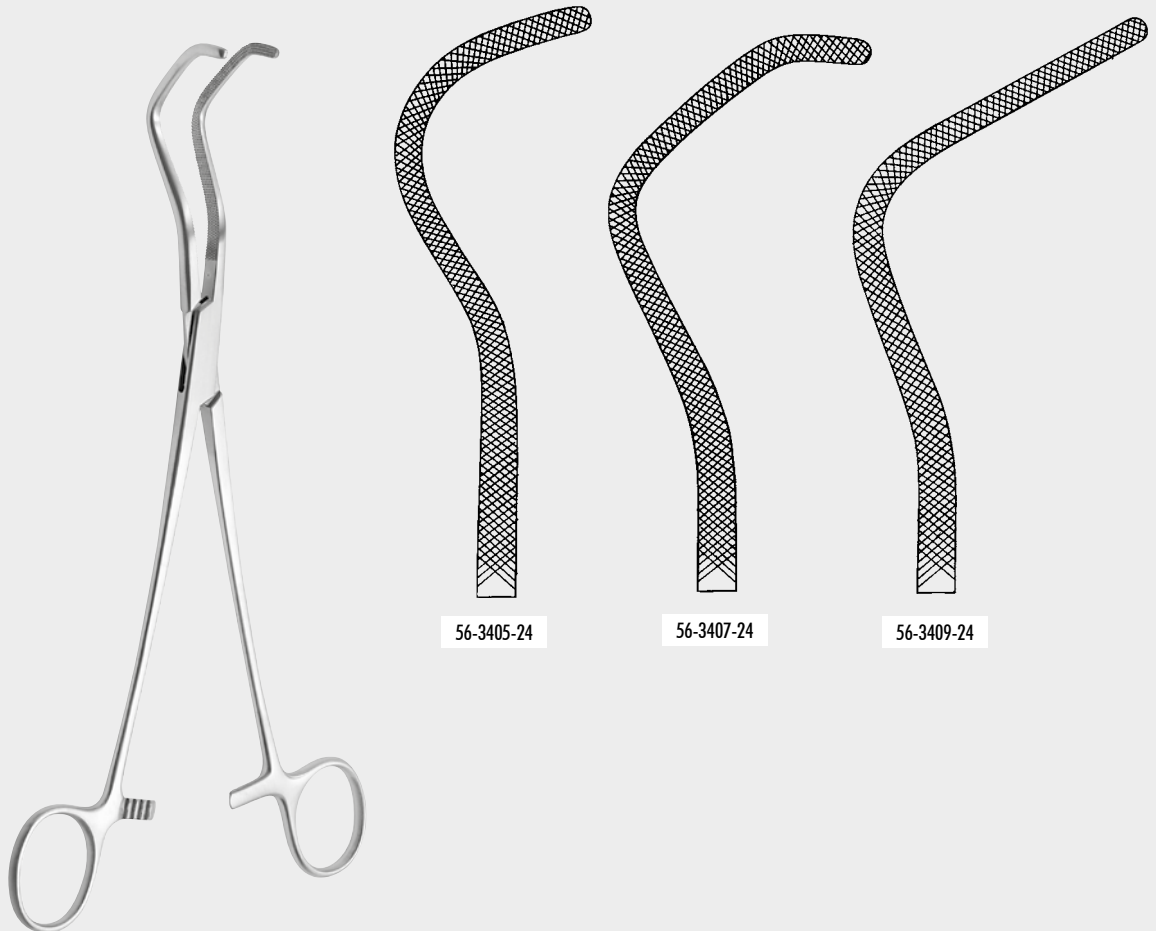

cm HARKEN
24,0 56-3405-24 - 56-3409-24



56-3403-24

56.18



cm DERRA
18,0 56-3501-18 - 56-3505-18

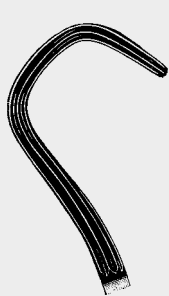

56-3501-18

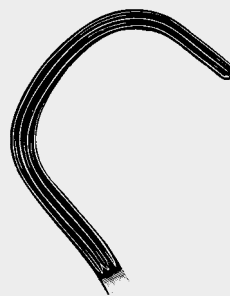

56-3505-18

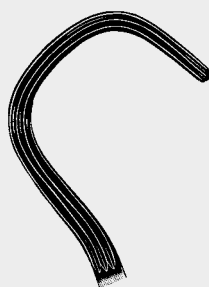

56-3503-18

Gefäßklemmen
Vascular Forceps
Pinces vasculaires
Pinzas vasculares
Pinze vascolari

THORAX

THORAX

THORAX

TÓRAX

TORACE



mm x mm BORST 21,5 cm
15 x 15 56-3510-21



mm RUMMEL BELMONT
3,2 56-4300-32
6,4 56-4300-64



mm
2,0 56-4301-32

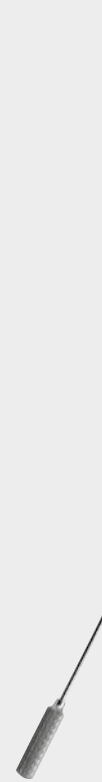

mm
2,5 56-4301-64



56-4301-64

56.19

Dilatatoren
Dilators
Dilatateurs
Dilatadores
Dilatatori

THORAX

THORAX

THORAX

TÓRAX

TORACE



biegsam
malleable
malléables
maleables
malleabili



cm COOLEY
13,0 56-4700-05 - 56-4700-50



biegsam
malleable
malléables
maleables
malleabili

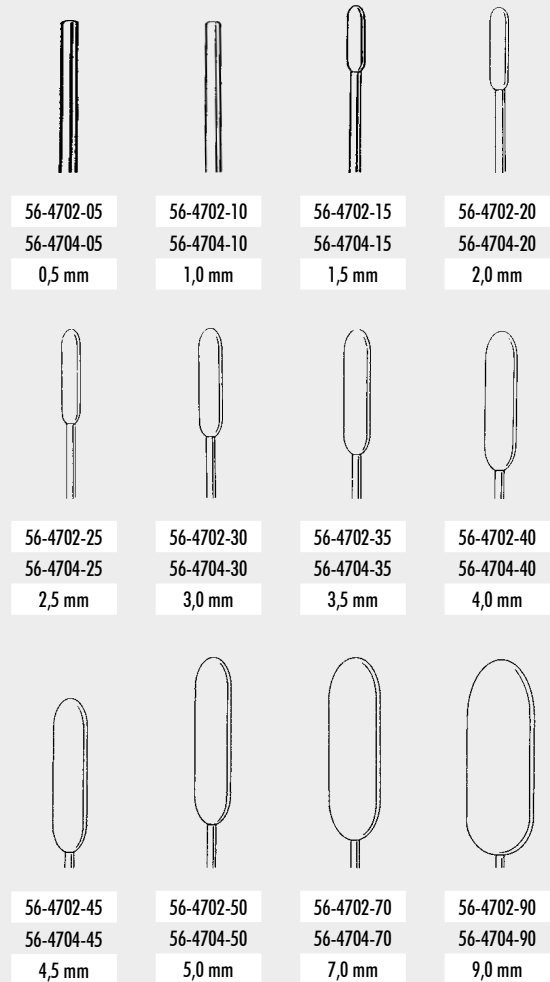

cm DE BAKEY
19,0 56-4702-05 - 56-4702-90
35,0 56-4704-05 - 56-4704-90



56-4704-90

56.20



biegsam
malleable
malléables
maleables
malleabili

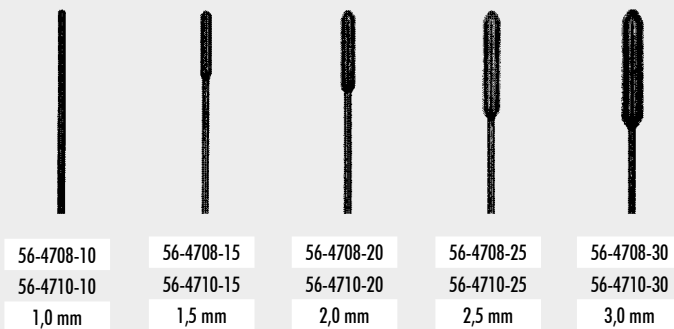

56-4708-10	56-4708-15	56-4708-20	56-4708-25	56-4708-30
56-4710-10	56-4710-15	56-4710-20	56-4710-25	56-4710-30
1,0 mm	1,5 mm	2,0 mm	2,5 mm	3,0 mm

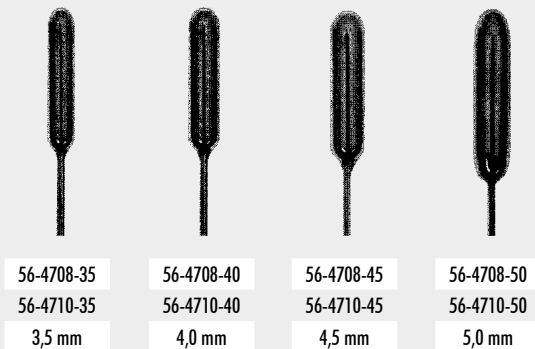

56-4708-35	56-4708-40	56-4708-45	56-4708-50
56-4710-35	56-4710-40	56-4710-45	56-4710-50
3,5 mm	4,0 mm	4,5 mm	5,0 mm

cm	GARRETT
14,0	56-4708-10 - 56-4708-50
22,0	56-4710-10 - 56-4710-50

Dilatatore
Dilators
Dilateurs
Dilatadores
Dilatatori

THORAX

THORAX

THORAX

TÓRAX

TORACE

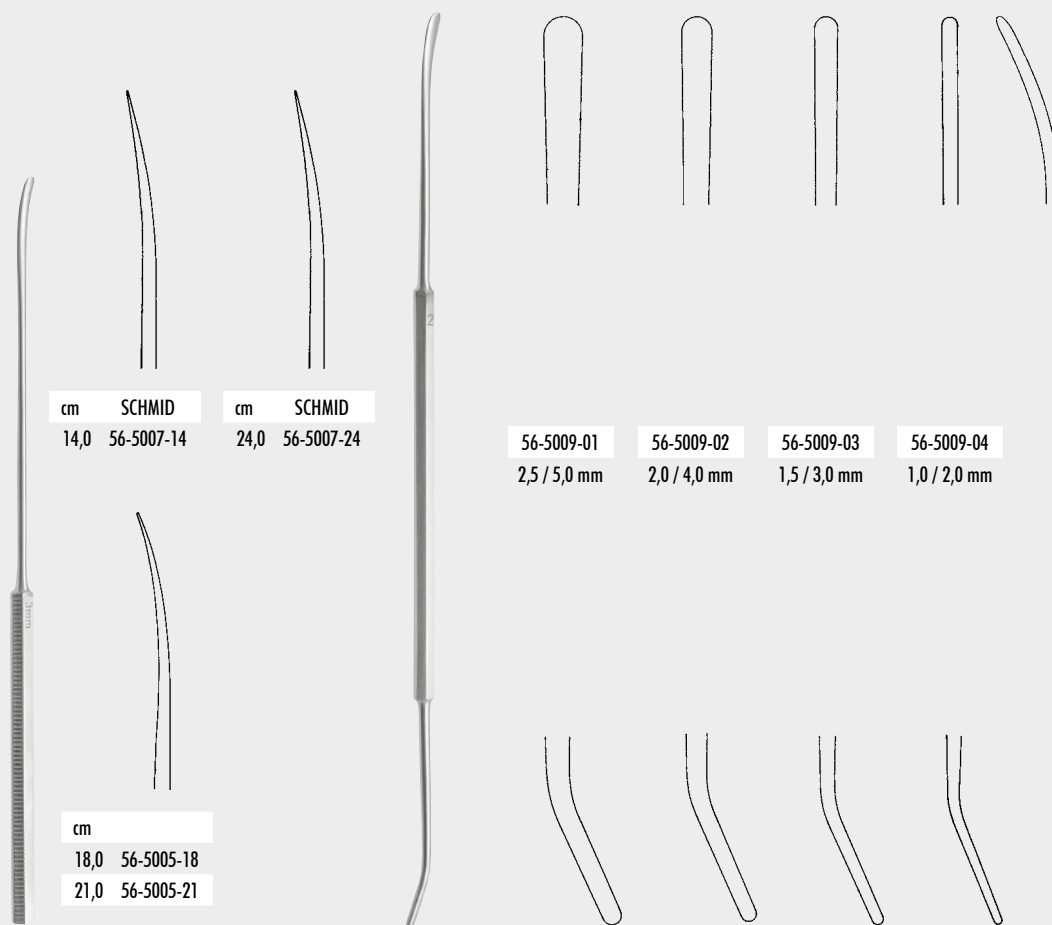

cm	SCHMID	cm	SCHMID
14,0	56-5007-14	24,0	56-5007-24

56-5009-01	56-5009-02	56-5009-03	56-5009-04
2,5 / 5,0 mm	2,0 / 4,0 mm	1,5 / 3,0 mm	1,0 / 2,0 mm

cm	
18,0	56-5005-18
21,0	56-5005-21

56-5005-18 - 56-5007-24

cm	ROBB
24,0	56-5009-01 - 56-5009-04

Spatel, Dissektoren
Spatulas, Dissectors
Spatules, Dissecteurs
Espátulas, Disecadores
Spatole, Dissettori



56-4708-10 - 56-5009-04

56.21