



CARDIOVASCULAR  
INSTRUMENTE

CARDIOVASCULAR  
INSTRUMENTS

INSTRUMENTS  
CARDIOVASCULAIRES

INSTRUMENTOS  
CARDIOVASCULARES

STRUMENTI  
CARDIOVASCOLARI

Distributed in New Zealand by:



Cooper Medical Limited  
57 Mahunga Drive  
Mangere Bridge  
Auckland 2022



EDITION 06/2016

ZEPF®  
INSTRUMENTS  
TUTTLINGEN  
GERMANY



CARDIOVASCULAR  
INSTRUMENTE

CARDIOVASCULAR  
INSTRUMENTS

INSTRUMENTS  
CARDIOVASCULAIRES

INSTRUMENTOS  
CARDIOVASCULARES

STRUMENTI  
CARDIOVASCOLARI





DEBAKEY HALSTEAD MOSQUITO  
13-0800-12 - 13-0801-15



13-0800-12  
12 cm



13-0801-12  
12 cm



13-0800-15  
15 cm



13-0801-15  
15 cm



13-0802-14  
14 cm



13-0802-16  
16 cm



13-0802-18  
18 cm



13-0802-20  
20 cm



PEAN  
13-0802-14 - 13-0803-20



13-0803-14  
14 cm



13-0803-16  
16 cm



13-0803-18  
18 cm



13-0803-20  
20 cm

CARDIOVASCULAR  
INSTRUMENTE

CARDIOVASCULAR  
INSTRUMENTS

INSTRUMENTS  
CARDIOVASCULAIRES

PINZAS VASCULARES  
ATRAUMÁTICAS

INSTRUMENTOS  
CARDIOVASCULARES



13-0800-12 - 13-0803-20



ATRAUMA



DEBAKEY



13-0804-16



13-0805-16

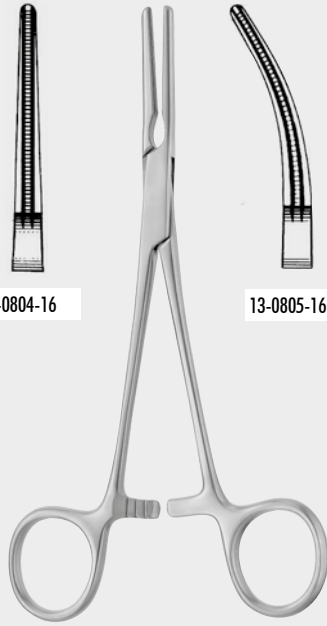

DEBAKEY RANKIN  
13-0804-16 - 13-0805-16  
16,0 cm



13-1002-12



13-1003-12

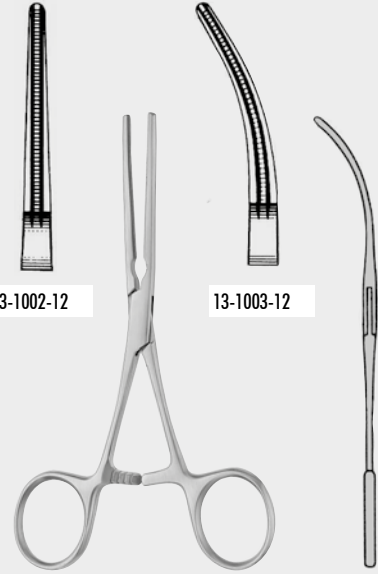

DEBAKEY  
13-1002-12 - 13-1003-12  
12,0 cm

CARDIOVASCULAR INSTRUMENTE

CARDIOVASCULAR INSTRUMENTS

INSTRUMENTS CARDIOVASCULAIRES

INSTRUMENTOS CARDIOVASCULARES

STRUMENTI CARDIOVASCOLARI



DEBAKEY  
13-1103-12  
11 cm



DEBAKEY  
13-1101-12  
12 cm



DEBAKEY  
13-1201-12  
12 cm



13-0804-16



ATRAUMA



DEBAKEY

Bronchusklemmen  
Bronchus Clamps  
Pinces pour les bronches  
Pinzas bronquiales  
Pinze per bronchi



LEES  
13-1301-23 - 13-1303-25  
23 cm

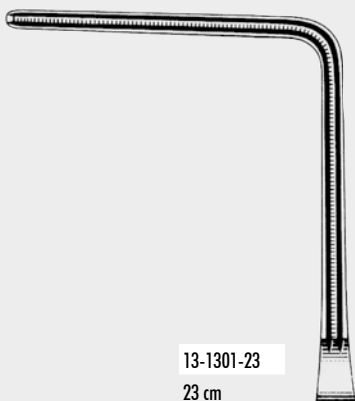

13-1301-23  
23 cm

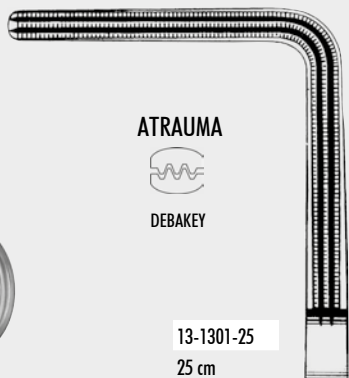

ATRAUMA



DEBAKEY

13-1301-25  
25 cm

CARDIOVASCULAR  
INSTRUMENTE

CARDIOVASCULAR  
INSTRUMENTS

INSTRUMENTS  
CARDIOVASCULAIRES

PINZAS VASCULARES  
ATRAUMÁTICAS

INSTRUMENTOS  
CARDIOVASCULARES



LEES  
13-1303-25  
25 cm

ZEPF<sup>®</sup>  
INSTRUMENTS

13-1303-25



ATRAUMA



DEBAKEY

Coarctationsklemmen  
Coarctation Clamps  
Pinces à coarctation  
Pinzas para coarctación  
Pinze per coarctazione

CARDIOVASCULAR  
INSTRUMENTE

CARDIOVASCULAR  
INSTRUMENTS

INSTRUMENTS  
CARDIOVASCULAIRES

INSTRUMENTOS  
CARDIOVASCULARES

STRUMENTI  
CARDIOVASCOLARI



13-1400-20  
20 cm

13-1400-21  
21 cm

13-1400-22  
22 cm

13-1400-26  
26 cm

POTTS  
13-1400-20 - 13-1400-26



15°



13-1401-20  
20 cm



13-1401-22  
22 cm

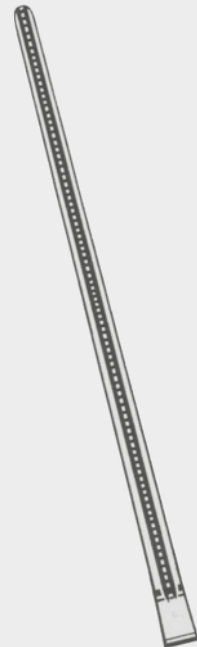

13-1401-26  
26 cm

GLOVER  
13-1401-20 - 13-1401-26

ZEPF®  
INSTRUMENTS

13-1400-20

ATRAUMA



DEBAKEY



Coarctationsklemmen  
Coarctation Clamps  
Pinces à coarctation  
Pinzas para coarctación  
Pinze per coarctazione



POTTS  
13-1403-21 - 13-1403-22



13-1403-21  
21 cm

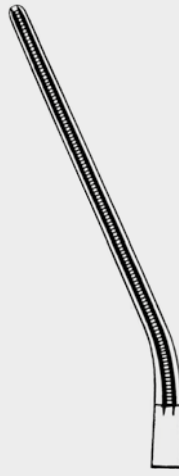

13-1403-22  
22 cm



CARDIOVASCULAR  
INSTRUMENTE

CARDIOVASCULAR  
INSTRUMENTS

INSTRUMENTS  
CARDIOVASCULAIRES

PINZAS VASCULARES  
ATRAUMÁTICAS

INSTRUMENTOS  
CARDIOVASCULARES



POTTS  
13-1405-21 - 13-1405-22

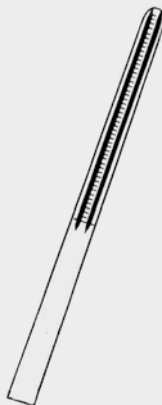

13-1405-21  
21 cm



13-1405-22  
22 cm



ZEPF<sup>®</sup>  
**Q**  
INSTRUMENTS

13-1405-22



ATRAUMA



DEBAKEY

Anastomosenklemmen  
Anastomosis Clamps  
Pinces à anastomose  
Pinzas para anastomosis  
Pinze per anastomosi

CARDIOVASCULAR  
INSTRUMENTE

CARDIOVASCULAR  
INSTRUMENTS

INSTRUMENTS  
CARDIOVASCULAIRES

INSTRUMENTOS  
CARDIOVASCULARES

STRUMENTI  
CARDIOVASCOLARI



GLOVER

13-1501-21 - 13-1501-24

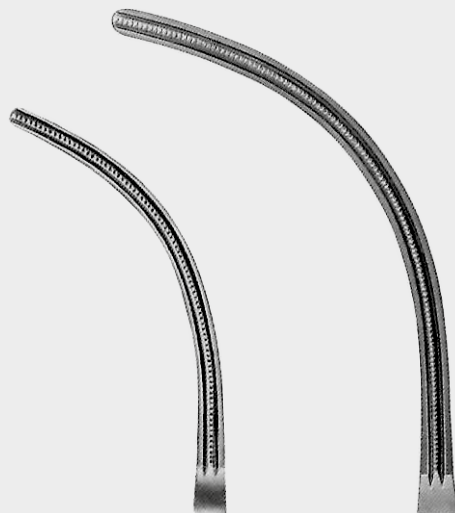

13-1501-21

21 cm

13-1501-24

24 cm



GLOVER

13-1503-18 - 13-1503-22



13-1503-18

18 cm

13-1503-22

22 cm



INSTRUMENTS

13-1501-21





GLOVER  
13-1601-21  
21 cm

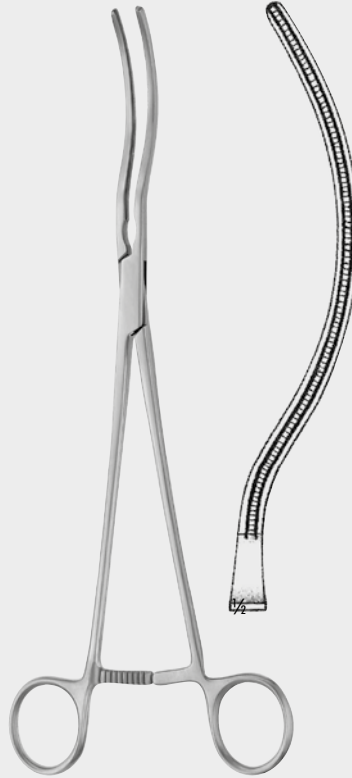

GLOVER  
13-1601-26  
26 cm



Anastomosenklemmen  
Anastomosis Clamps  
Pinces à anastomose  
Pinzas para anastomosis  
Pinze per anastomosi

CARDIOVASCULAR  
INSTRUMENTE

CARDIOVASCULAR  
INSTRUMENTS

INSTRUMENTS  
CARDIOVASCULAIRES

PINZAS VASCULARES  
ATRAUMÁTICAS

INSTRUMENTOS  
CARDIOVASCULARES

Peripheal-Gefäßklemmen  
Peripheal Vascular Forceps  
Pince vasculaires périphériques  
Pinzas vasculares periféricos  
Pinze vascolari periferali



DEBAKEY  
13-1700-19 - 13-1700-22



13-1700-19  
19 cm



13-1700-22  
22 cm



DEBAKEY  
13-1701-19 - 13-1701-22



13-1701-19  
19 cm

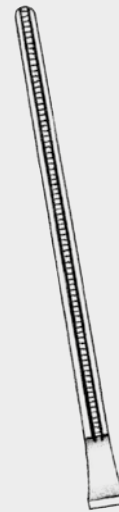

13-1701-22  
22 cm



ATRAUMA



DEBAKEY

Atraumatische Mehrzweckklemmen  
Atraumatic Multi-Purpose Clamps  
Pinces-clamps polyvalentes  
Pinzas clamps para usos varios  
Pinze atraumatiche per diversi usi



DARDIK  
13-1702-00 - 13-1704-90



13-1702-00  
15 cm



15°  
13-1702-15  
15 cm



30°  
13-1702-30  
15 cm



45°  
13-1702-45  
15 cm



90°  
13-1702-90  
14 cm

CARDIOVASCULAR INSTRUMENTE

CARDIOVASCULAR INSTRUMENTS

INSTRUMENTS CARDIOVASCULAIRES

INSTRUMENTOS CARDIOVASCULARES

STRUMENTI CARDIOVASCOLARI



13-1704-00  
17 cm

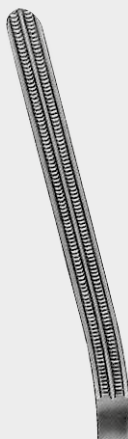

15°  
13-1704-15  
17 cm

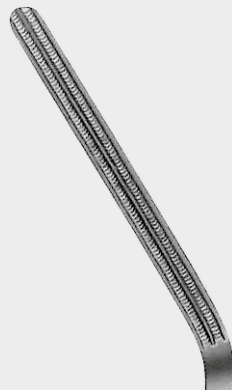

30°  
13-1704-30  
17 cm



45°  
13-1704-45  
17 cm



90°  
13-1704-90  
16 cm



13-1702-00

ATRAUMA



DEBAKEY



Peripheal-Gefäßklemmen  
Peripheal Vascular Clamps  
Pinces vasculaires périphériques  
Pinzas vasculares periféricas  
Pinze vascolari periferali

CARDIOVASCULAR  
INSTRUMENTE

CARDIOVASCULAR  
INSTRUMENTS

INSTRUMENTS  
CARDIOVASCULAIRES

PINZAS VASCULARES  
ATRAUMÁTICAS

INSTRUMENTOS  
CARDIOVASCULARES

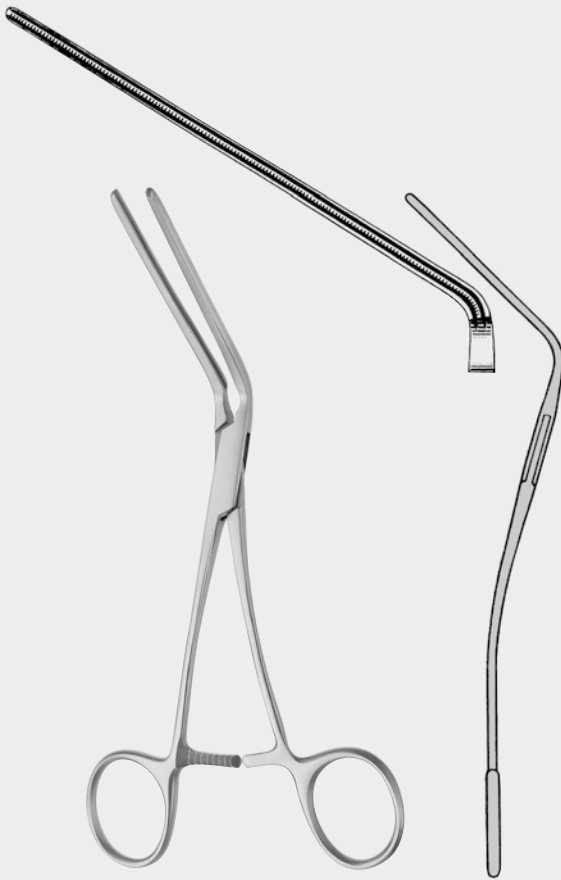

LELAND JONES  
13-1801-19  
19 cm

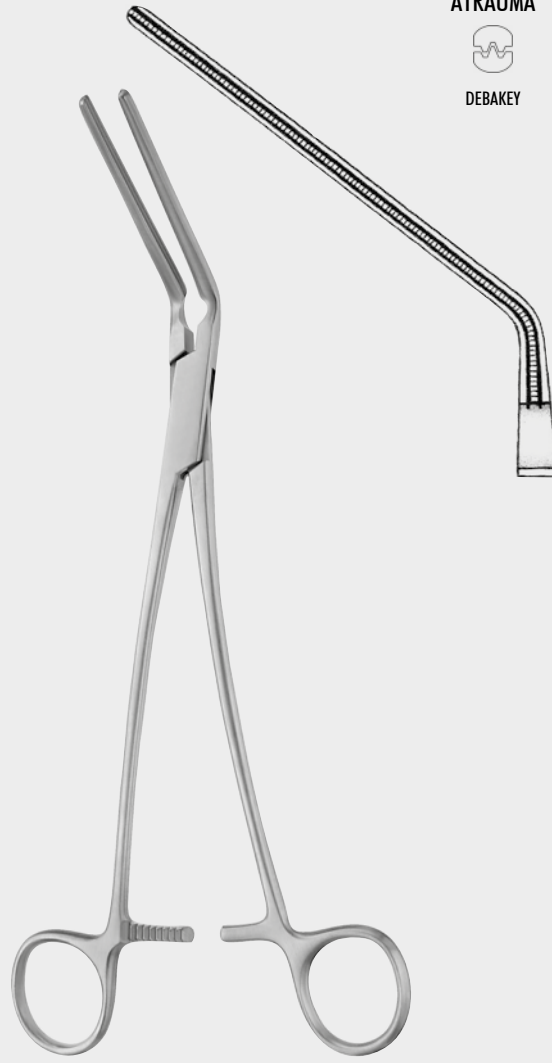

DEBAKEY  
13-1801-26  
26 cm



DEBAKEY  
13-1803-19 - 13-1901-16

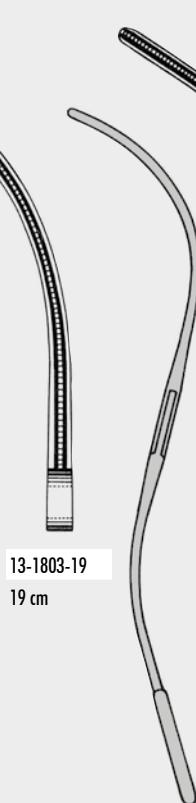

13-1803-19  
19 cm

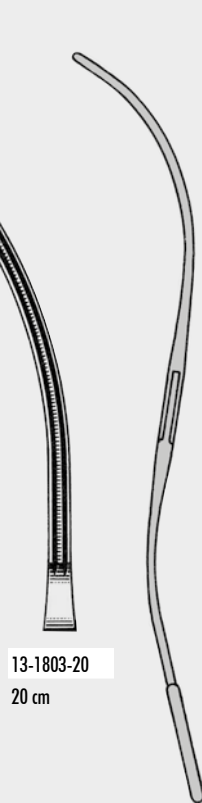

13-1803-20  
20 cm

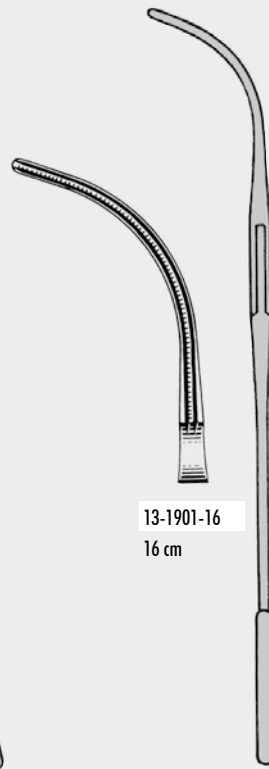

13-1901-16  
16 cm



13-1901-16



**ATRAUMA**



DEBAKEY

Atraumatische Mehrzweckklemmen  
Atraumatic Multi-Purpose Clamps  
Pincés-clamps polyvalentes  
Pinzas clamps para usos varios  
Pinze atraumatiche per diversi usi

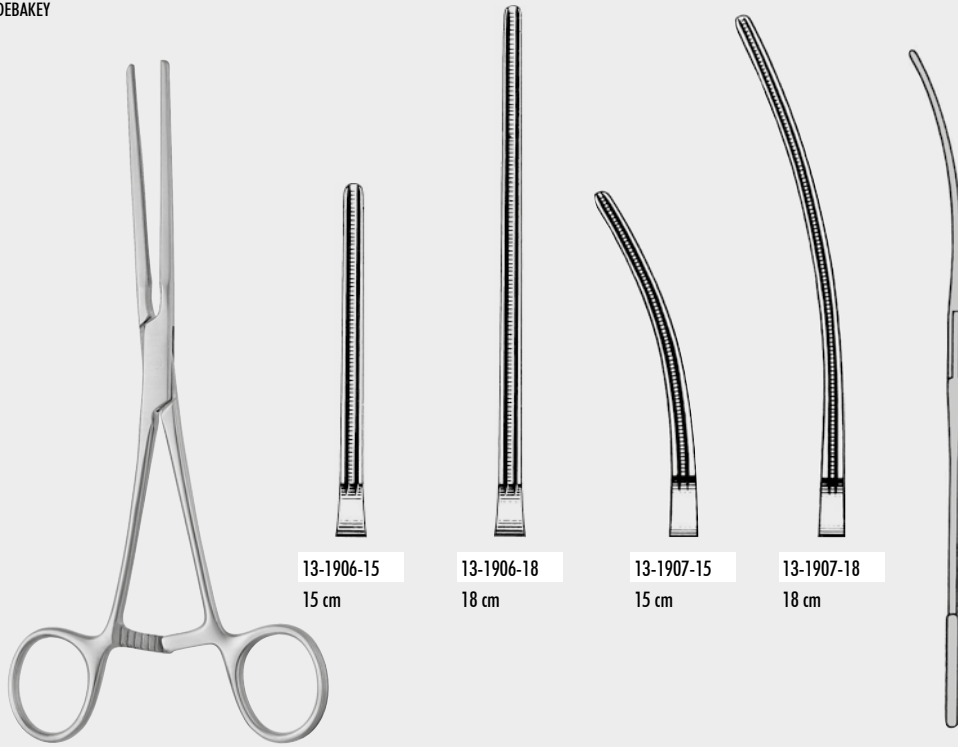

13-1906-15  
15 cm

13-1906-18  
18 cm

13-1907-15  
15 cm

13-1907-18  
18 cm

**CARDIOVASCULAR INSTRUMENTE**

**CARDIOVASCULAR INSTRUMENTS**

**INSTRUMENTS CARDIOVASCULAIRES**

**INSTRUMENTOS CARDIOVASCULARES**

**STRUMENTI CARDIOVASCOLARI**

Peripheal-Gefäßklemmen  
Peripheal Vascular Clamps  
Pincés vasculaires périphériques  
Pinzas vasculares periféricos  
Pinze vascolari periferali

**BAINBRIDGE**  
13-1906-15 - 13-1907-18



13-2002-19  
19 cm

13-2003-19  
19 cm

13-2005-19  
19 cm

**LELAND JONES**  
13-2002-19 - 13-2005-19



13-1906-15

ATRAUMA



DEBAKEY



Peripheal-Gefäßklemmen  
Peripheal Vascular Clamps  
Pincés-clamps, vasculaires périphériques  
Pinzas para vasos periféricos  
Pinze vascolari periferali

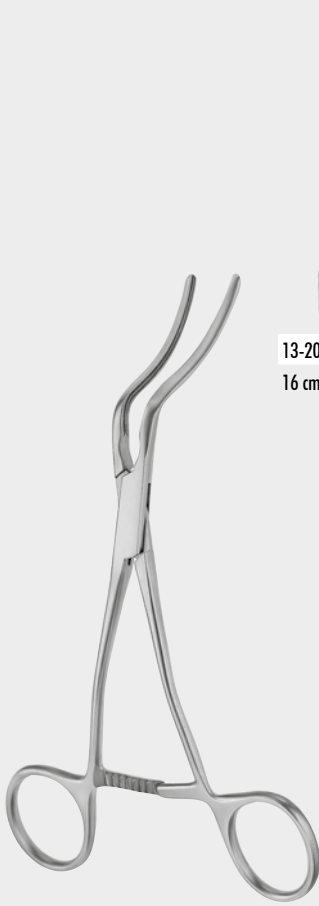

13-2007-16  
16 cm

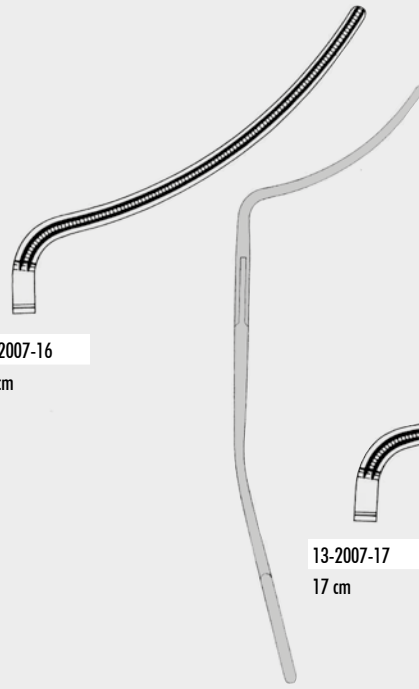

13-2007-17  
17 cm

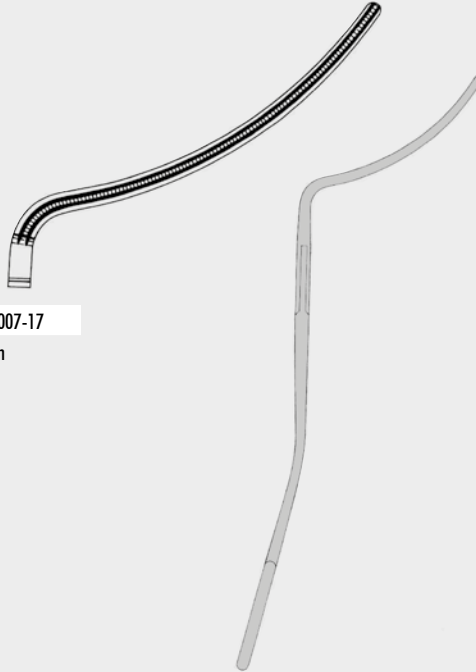

MARTIN

13-2007-16 - 13-2007-20

CARDIOVASCULAR  
INSTRUMENTE

CARDIOVASCULAR  
INSTRUMENTS

INSTRUMENTS  
CARDIOVASCULAIRES

PINZAS VASCULARES  
ATRAUMÁTICAS

INSTRUMENTOS  
CARDIOVASCULARES

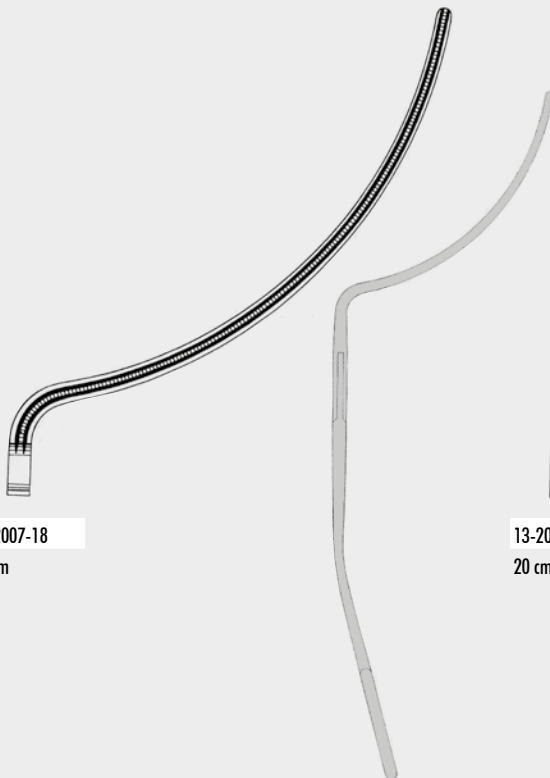

13-2007-18  
18 cm

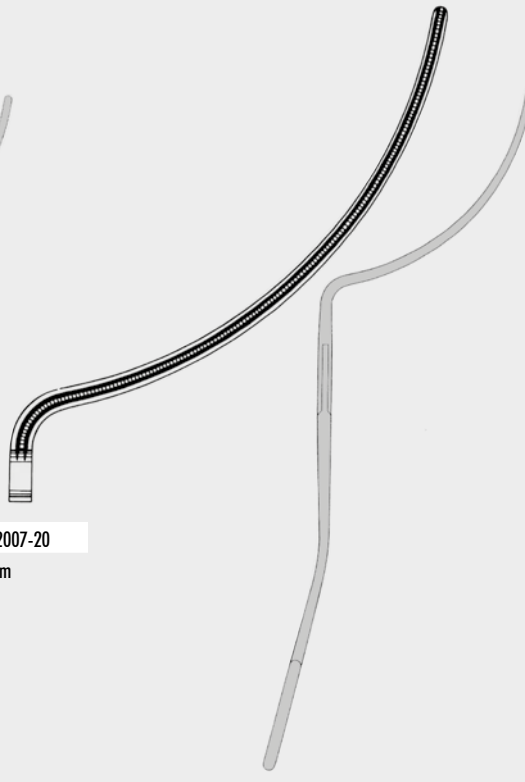

13-2007-20  
20 cm

ZEPF<sup>®</sup>  
**α**  
INSTRUMENTS

13-2007-20



ATRAUMA



DEBAKEY

Aortaklemmen  
Aortic Clamp  
Pince-clamp à aorte  
Pinza clamp para aorta  
Pinza per aorta

CARDIOVASCULAR  
INSTRUMENTE

CARDIOVASCULAR  
INSTRUMENTS

INSTRUMENTS  
CARDIOVASCULAIRES

INSTRUMENTOS  
CARDIOVASCULARES

STRUMENTI  
CARDIOVASCOLARI

Aorta-Anastomosenklemmen  
Aorta-Anastomosis Clamps  
Pinces-clamps pour anastomoses d'aorte  
Pinzas clamps para anastomosis de aorta  
Pinze aortiche

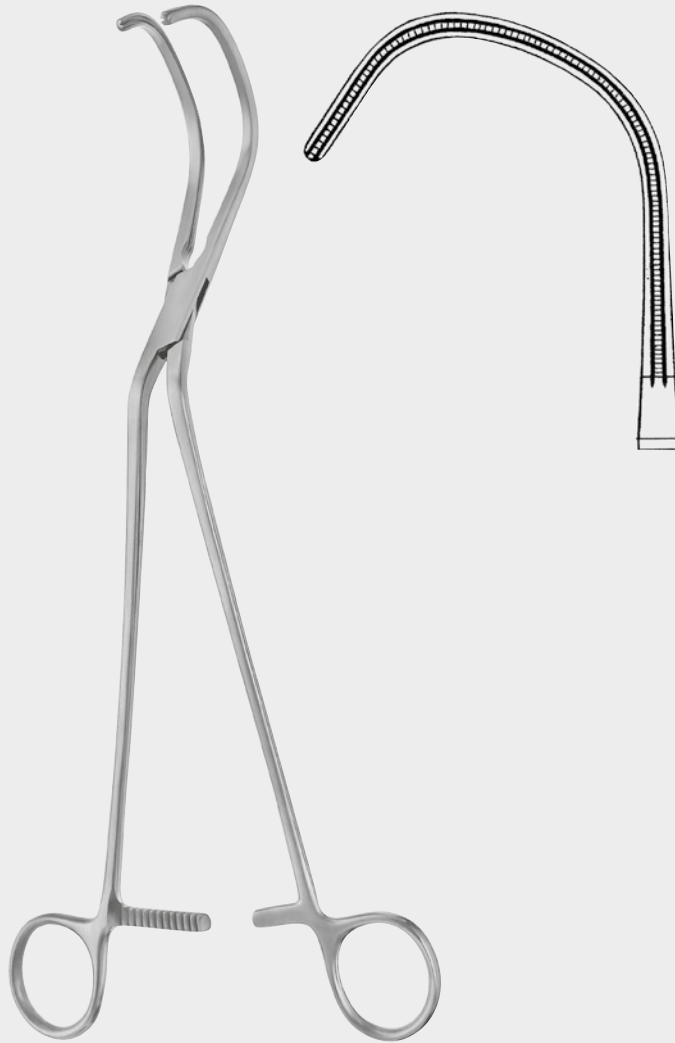

LIDDLE  
13-2009-27  
27 cm



LAMBERT KAY  
13-2101-20 - 13-2103-20  
20 cm

13-2101-20

13-2103-20

ZEPF®  
INSTRUMENTS

13-2009-27

14

ATRAUMA



DEBAKEY



DEBAKEY  
13-2105-20  
20 cm

Iliaca-Klemme  
Iliac Clamp  
Pince-clamp à iliaque  
Pinza clamp para iliaca  
Pinza per iliaca

CARDIOVASCULAR  
INSTRUMENTE

CARDIOVASCULAR  
INSTRUMENTS

INSTRUMENTS  
CARDIOVASCULAIRES

PINZAS VASCULARES  
ATRAUMÁTICAS

INSTRUMENTOS  
CARDIOVASCULARES

Aortaklemmen  
Aortic Clamp  
Pince-clamp à aorte  
Pinza clamp para aorta  
Pinza per aorta



WEBER  
13-2107-26  
26 cm



WEBER  
13-2109-26  
26 cm



13-2109-26



ATRAUMA



DEBAKEY

Aorta-Aneurysma-Klemmen  
Aorta-Aneurysm Clamps  
Pinces-clamps pour aneurysme d'aorte  
Pinzas clamps para aneurisma de aorta  
Pinze per aneurisma di aorta

CARDIOVASCULAR  
INSTRUMENTE

CARDIOVASCULAR  
INSTRUMENTS

INSTRUMENTS  
CARDIOVASCULAIRES

INSTRUMENTOS  
CARDIOVASCULARES

STRUMENTI  
CARDIOVASCOLARI

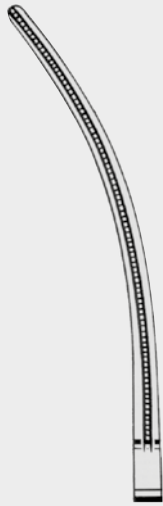

13-2201-24  
24 cm



13-2201-27  
27 cm



13-2201-30  
30 cm



13-2201-31  
31 cm

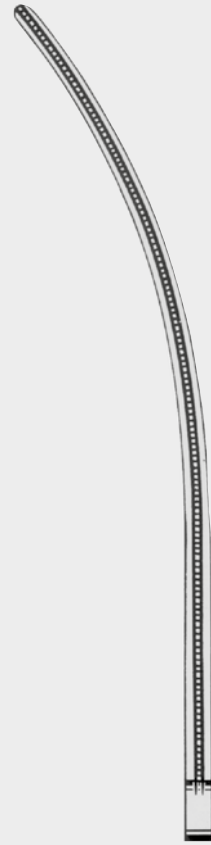

13-2201-35  
33 cm

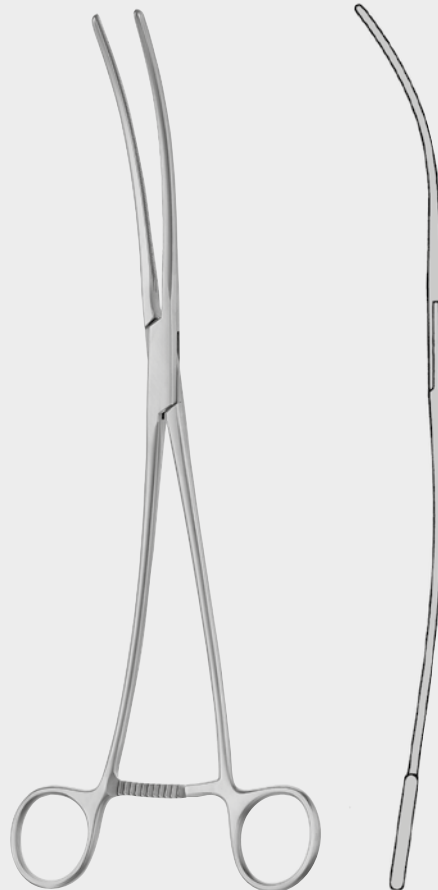

DEBAKEY  
13-2201-24 - 13-2201-35

ZEPF®  
INSTRUMENTS

13-2201-24



ATRAUMA



DEBAKEY



DEBAKEY BAHNSON  
13-2203-24 - 13-2203-26



13-2203-24  
24 cm



13-2203-25  
25 cm



13-2203-26  
26 cm



CARDIOVASCULAR  
INSTRUMENTE

CARDIOVASCULAR  
INSTRUMENTS

INSTRUMENTS  
CARDIOVASCULAIRES

PINZAS VASCULARES  
ATRAUMÁTICAS

INSTRUMENTOS  
CARDIOVASCULARES

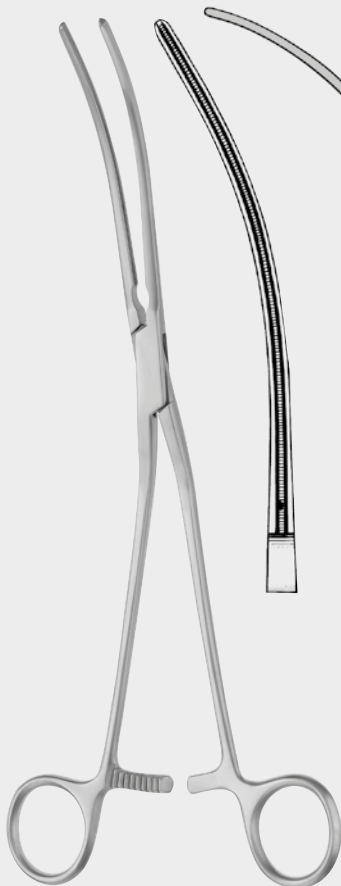

DEBAKEY  
13-2205-28  
28 cm



DEBAKEY  
13-2207-28  
28 cm

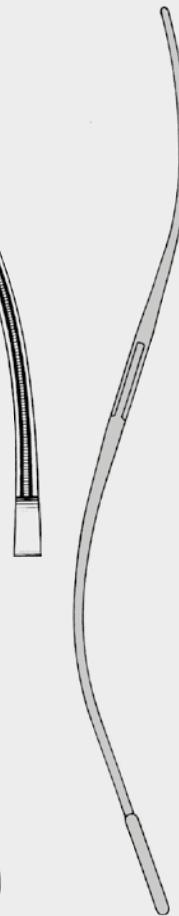

13-2207-28



ATRAUMA



DEBAKEY

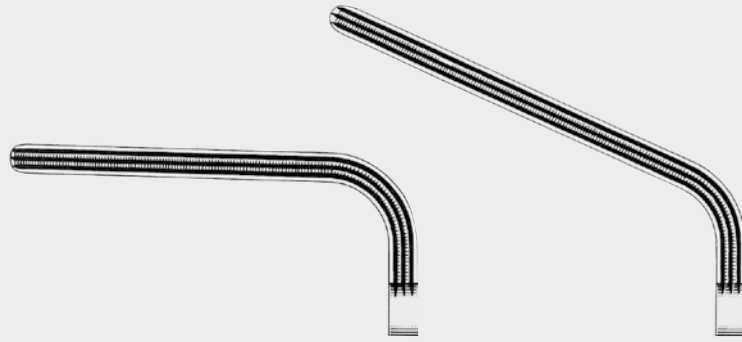

13-2209-18  
18 cm

13-2209-20  
20 cm

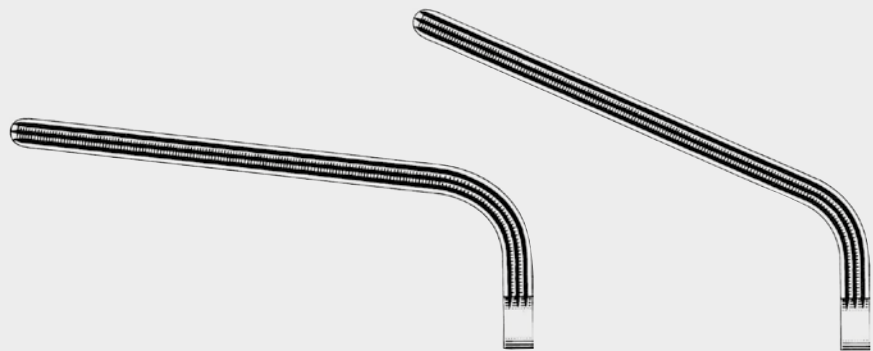

13-2209-23  
23 cm

13-2209-25  
25 cm

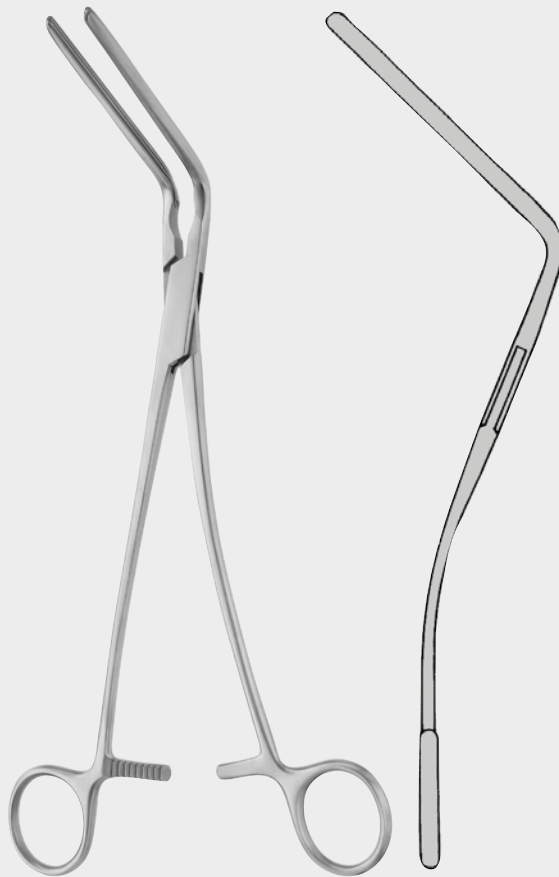

DEBAKEY MORRIS  
13-2209-18 - 13-2209-25

CARDIOVASCULAR  
INSTRUMENTE

CARDIOVASCULAR  
INSTRUMENTS

INSTRUMENTS  
CARDIOVASCULAIRES

INSTRUMENTOS  
CARDIOVASCULARES

STRUMENTI  
CARDIOVASCOLARI



INSTRUMENTS

13-2209-18

18

ATRAUMA



DEBAKEY



13-2301-27

27 cm



DEBAKEY

13-2301-18 - 13-2301-27

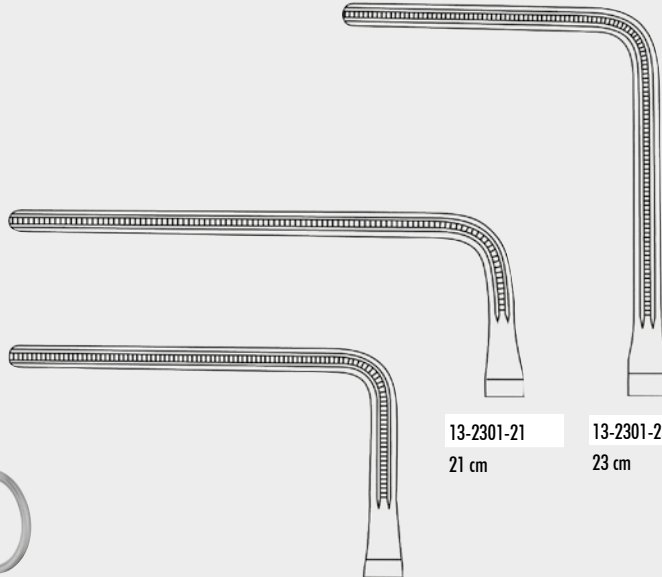

13-2301-21

21 cm

13-2301-23

23 cm

13-2301-18

18 cm

Atraumatische Mehrzweckklemmen  
Atraumatic Multi-Purpose Clamps  
Pinces-clamps polyvalentes  
Pinzas clamps para usos varios  
Pinze atraumatiche per diversi usi

CARDIOVASCULAR  
INSTRUMENTE

CARDIOVASCULAR  
INSTRUMENTS

INSTRUMENTS  
CARDIOVASCULAIRES

PINZAS VASCULARES  
ATRAUMÁTICAS

INSTRUMENTOS  
CARDIOVASCULARES

Aorta-Aneurysma-Klemmen  
Aorta-Aneurysm Clamps  
Pinces-clamps pour aneurysme d'aorte  
Pinzas clamps para aneurisma de aorta  
Pinze per aneurisma di aorta

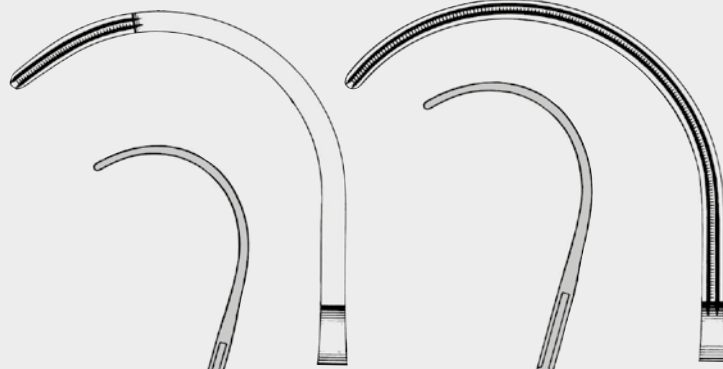

13-2401-25

25 cm

13-2401-26

25 cm



DEBAKEY

13-2401-25 - 13-2401-26

ZEPF<sup>®</sup>  
INSTRUMENTS

13-2401-26

19



ATRAUMA



DEBAKEY

Aorta-Aneurysma-Klemmen  
Aorta-Aneurysm Clamps  
Pinces-clamps pour aneurysme d'aorte  
Pinzas clamps para aneurisma de aorta  
Pinze per aneurisma di aorta

CARDIOVASCULAR  
INSTRUMENTE

CARDIOVASCULAR  
INSTRUMENTS

INSTRUMENTS  
CARDIOVASCULAIRES

INSTRUMENTOS  
CARDIOVASCULARES

STRUMENTI  
CARDIOVASCOLARI

Atraumatische Mehrzweckklemmen  
Atraumatic Multi-Purpose Clamps  
Pinces-clamps polyvalentes  
Pinzas clamps para usos varios  
Pinze atraumatiche per diversi usi



DEBAKEY  
13-2407-27  
27 cm

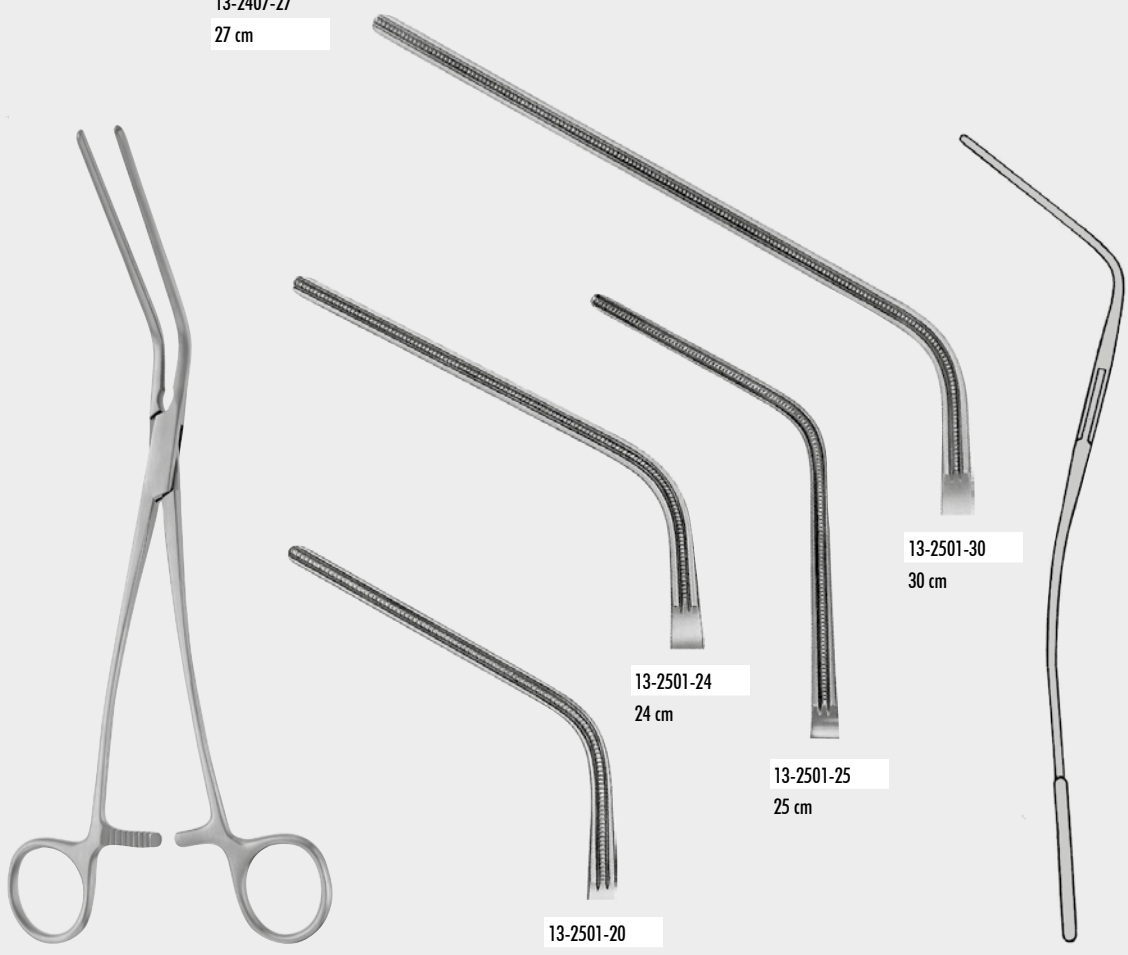

DEBAKEY  
13-2501-20 - 13-2501-30

13-2501-24  
24 cm

13-2501-30  
30 cm

13-2501-25  
25 cm

13-2501-20  
20 cm



13-2407-27



Tangentialklemmen  
Tangential Occlusion Clamps  
Pinces-clamps pour occlusion tangentielle  
Pinzas para oclusión tangencial  
Pinze per occlusione tangenziale

CARDIOVASCULAR  
INSTRUMENTE

CARDIOVASCULAR  
INSTRUMENTS

INSTRUMENTS  
CARDIOVASCULAIRES

PINZAS VASCULARES  
ATRAUMÁTICAS

INSTRUMENTOS  
CARDIOVASCULARES

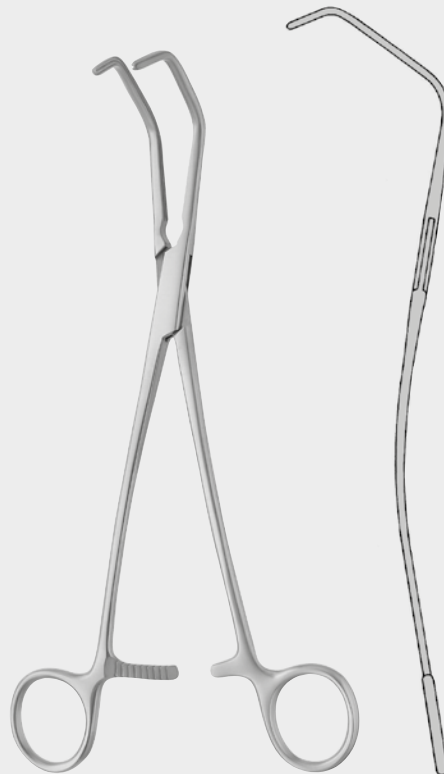
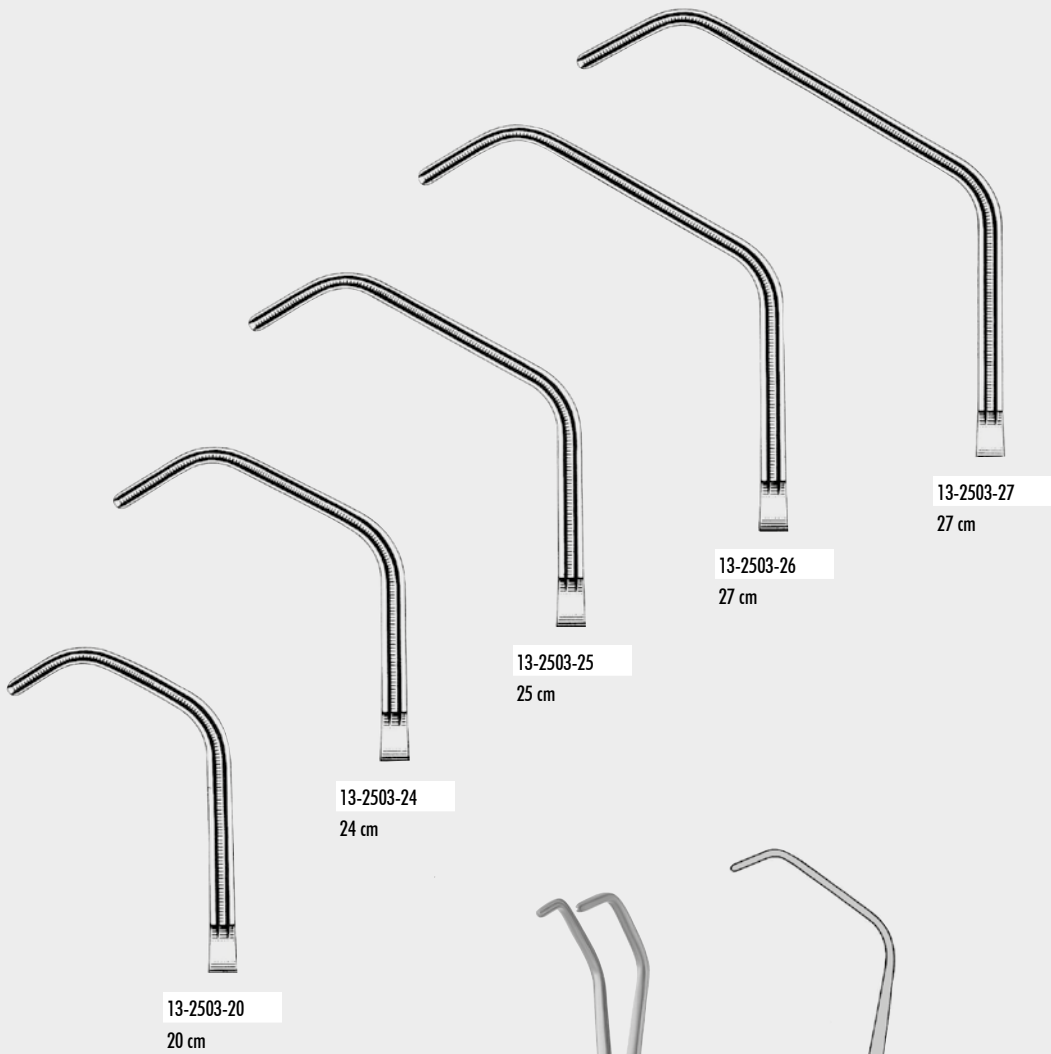

SATINSKY  
13-2503-20 - 13-2503-27



ATRAUMA



DEBAKEY

Tangentialklemmen  
Tangential Occlusion Clamps  
Pinces-clamps pour occlusion tangentielle  
Pinzas para oclusión tangencial  
Pinze per occlusione tangenziale



WYLIE

13-2509-01 - 13-2509-02

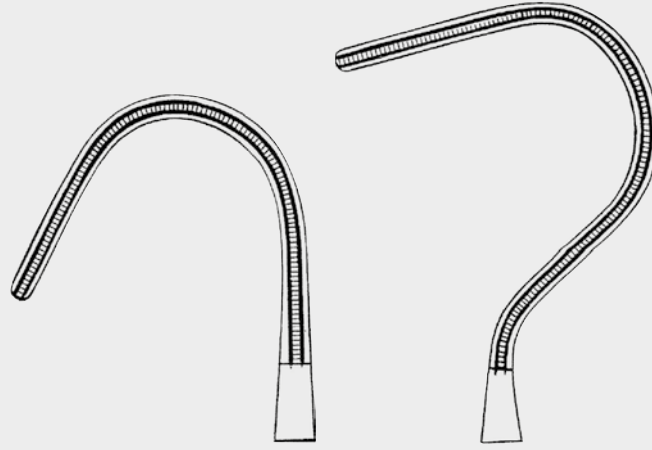

13-2509-01  
21 cm

13-2509-02  
22 cm

CARDIOVASCULAR  
INSTRUMENTE

CARDIOVASCULAR  
INSTRUMENTS

INSTRUMENTS  
CARDIOVASCULAIRES

INSTRUMENTOS  
CARDIOVASCULARES

STRUMENTI  
CARDIOVASCOLARI



DEBAKEY SATINSKY

13-2601-23 - 13-2601-25

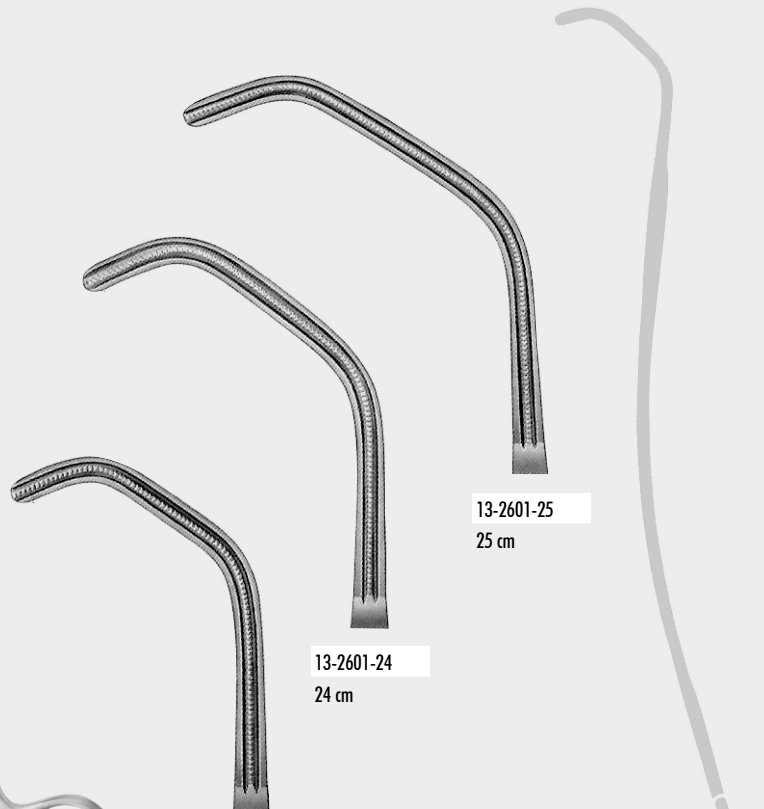

13-2601-23  
23 cm

13-2601-24  
24 cm

13-2601-25  
25 cm

ZEPF®  
INSTRUMENTS

13-2509-01

22

ATRAUMA



DEBAKEY



Aurikelklemmen  
Auricle Clamps  
Pincès auriculaires  
Pinzas para aurícula  
Pinze ventricolari



WYLIE  
13-2603-25 - 13-2609-24  
24 cm

13-2603-25

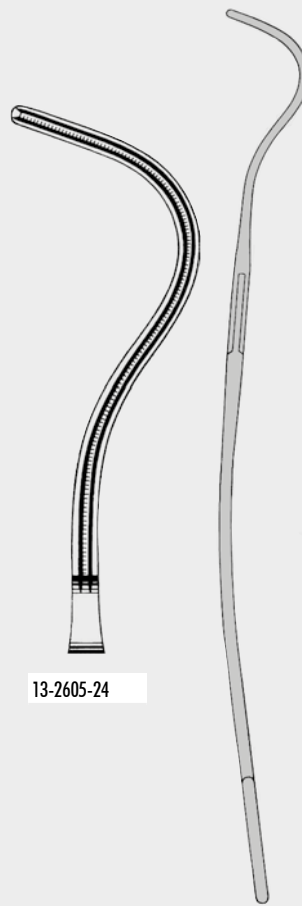

13-2605-24

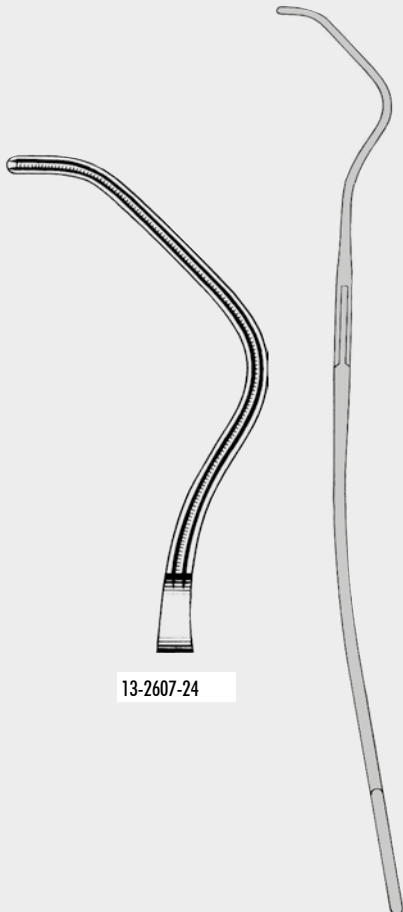

13-2607-24

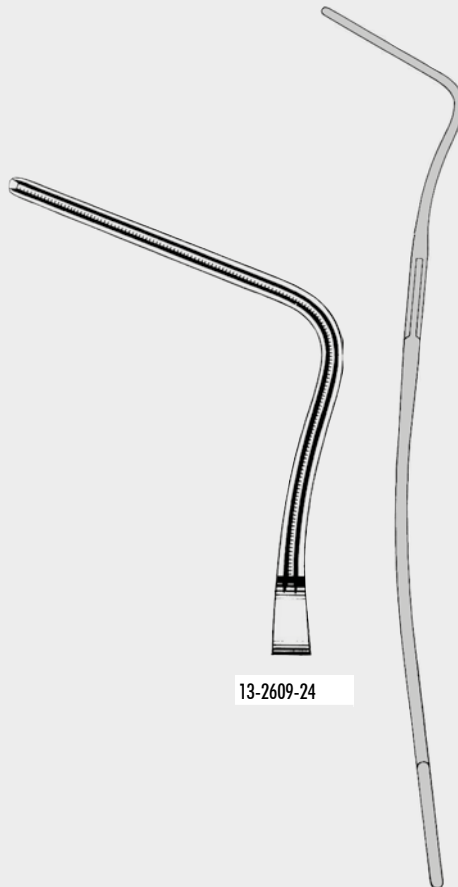

13-2609-24

CARDIOVASCULAR  
INSTRUMENTE

CARDIOVASCULAR  
INSTRUMENTS

INSTRUMENTS  
CARDIOVASCULAIRES

PINZAS VASCULARES  
ATRAUMÁTICAS

INSTRUMENTOS  
CARDIOVASCULARES



13-2609-24



ATRAUMA



DEBAKEY

Peripheal-Gefäßklemmen  
Peripheal Vascular Clamps  
Pincés-clamps, vasculaires périphériques  
Pinzas para vasos periféricos  
Pinze vascolari periferali

Organfaßzange  
Organ grasping forceps  
Pincés pour saisir des organes  
Pinzas para sacar órganos  
Pinze per afferrare organi

CARDIOVASCULAR INSTRUMENTE

CARDIOVASCULAR INSTRUMENTS

INSTRUMENTS CARDIOVASCULAIRES

INSTRUMENTOS CARDIOVASCULARES

STRUMENTI CARDIOVASCOLARI

Peripheal-Gefäßklemmen  
Peripheal Vascular Clamps  
Pincés-clamps, vasculaires périphériques  
Pinzas para vasos periféricos  
Pinze vascolari periferali

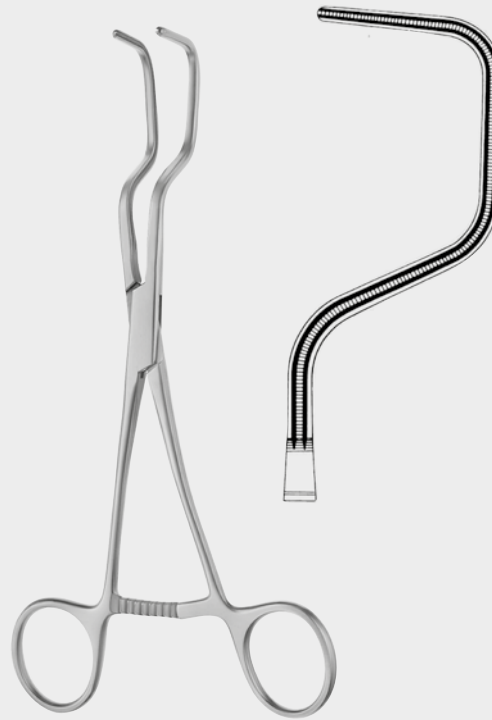

DALE  
13-2701-18  
18 cm

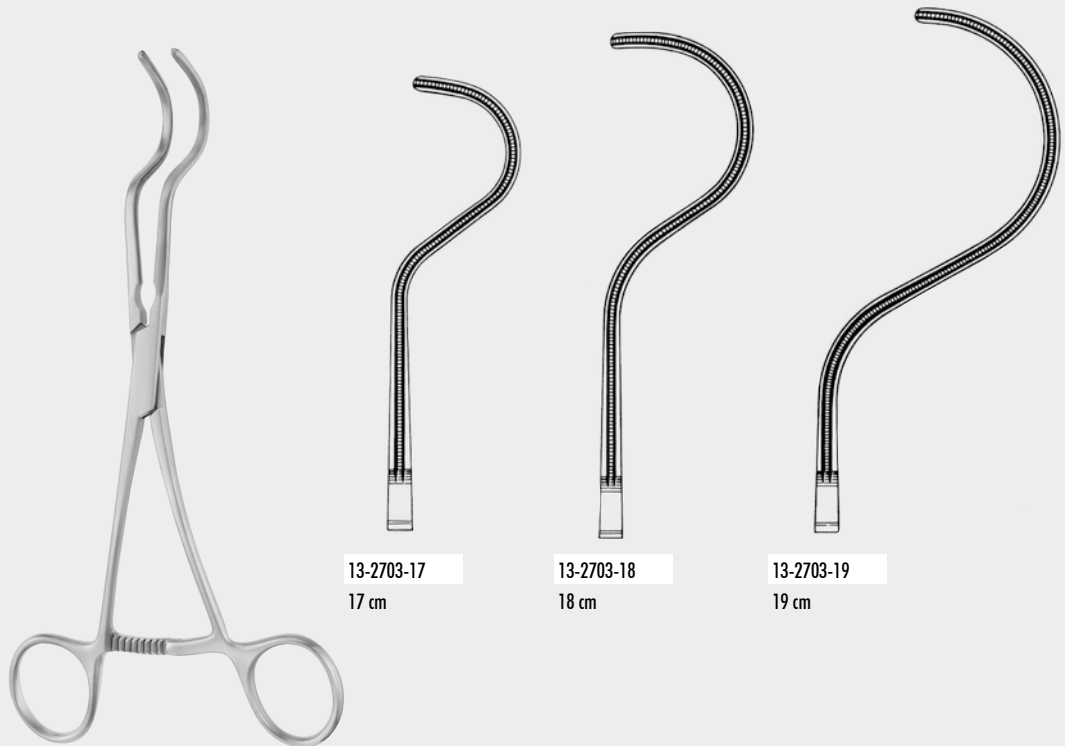

13-2703-17  
17 cm

13-2703-18  
18 cm

13-2703-19  
19 cm

DALE  
13-2703-17 - 13-2703-19



INSTRUMENTS

13-2701-18



ATRAUMA



DEBAKEY

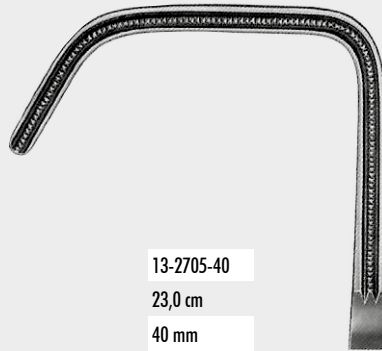

13-2705-40  
23,0 cm  
40 mm

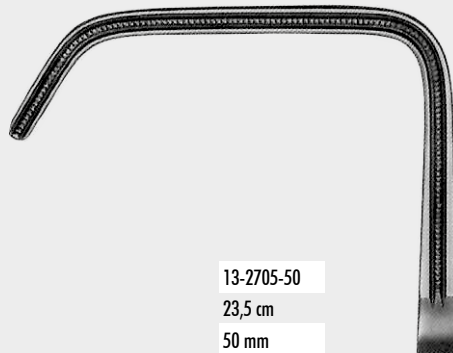

13-2705-50  
23,5 cm  
50 mm



HOPT  
13-2705-40 - 13-2705-60

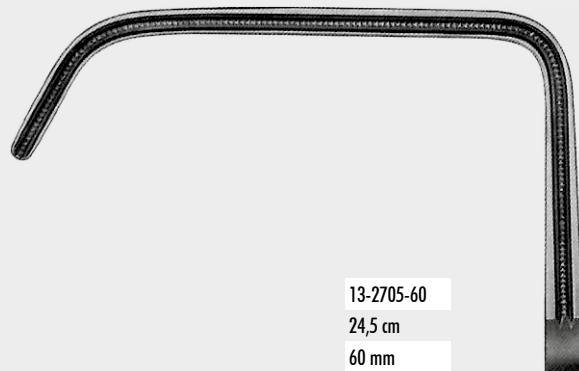

13-2705-60  
24,5 cm  
60 mm

CARDIOVASCULAR  
INSTRUMENTE

CARDIOVASCULAR  
INSTRUMENTS

INSTRUMENTS  
CARDIOVASCULAIRES

PINZAS VASCULARES  
ATRAUMÁTICAS

INSTRUMENTOS  
CARDIOVASCULARES

ZEPF<sup>®</sup>  
INSTRUMENTS

13-2705-60

25



**ATRAUMA**



DEBAKEY

Aorta-Anastomosenklemmen  
Aorta-Anastomosis Clamps  
Pincés-clamps pour anastomoses d'aorte  
Pinzas clamps para anastomosis de aorta  
Pinze aortiche

Atraumatische Mehrzweckklemmen  
Atraumatic Multi-Purpose Clamps  
Pincés-clamps polyvalentes  
Pinzas clamps para usos varios  
Pinze atraumatiche per diversi usi

**CARDIOVASCULAR  
INSTRUMENTE**

**CARDIOVASCULAR  
INSTRUMENTS**

**INSTRUMENTS  
CARDIOVASCULAIRES**

**INSTRUMENTOS  
CARDIOVASCULARES**

**STRUMENTI  
CARDIOVASCOLARI**

Atraumatische Mehrzweckklemmen  
Atraumatic Multi-Purpose Clamps  
Pincés-clamps polyvalentes  
Pinzas clamps para usos varios  
Pinze atraumatiche per diversi usi

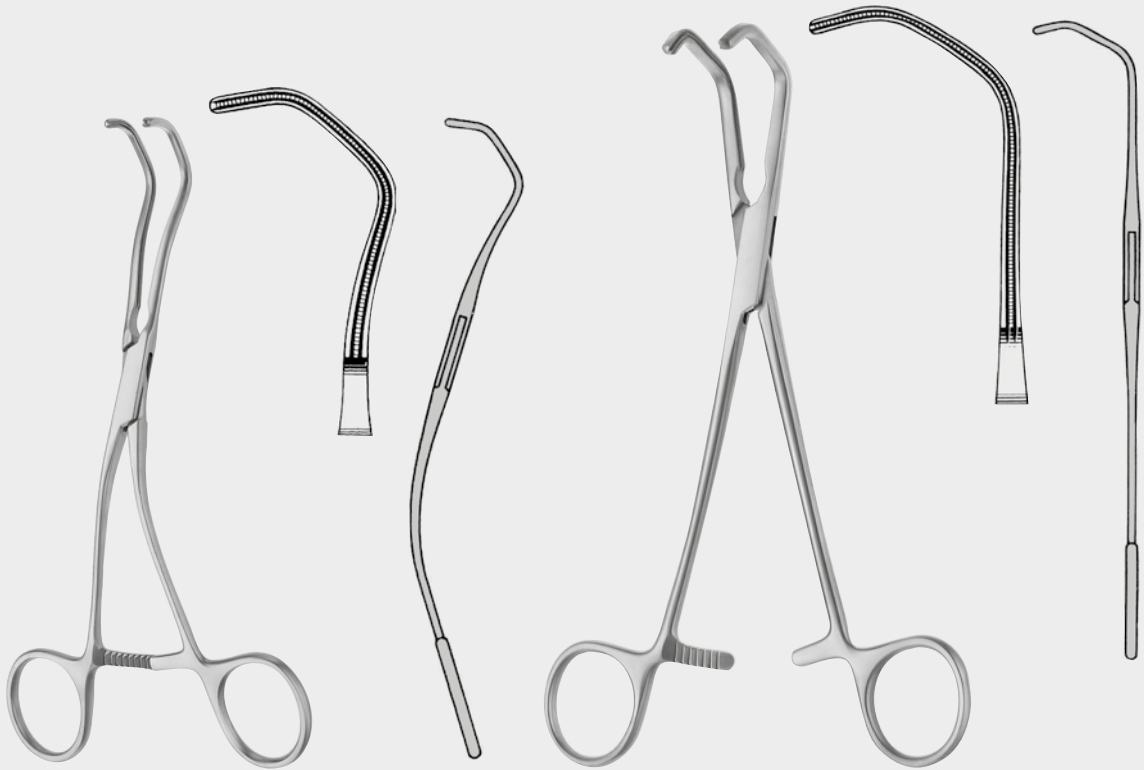

DEBAKEY  
13-2709-17  
17 cm

BECK  
13-2803-17  
17 cm

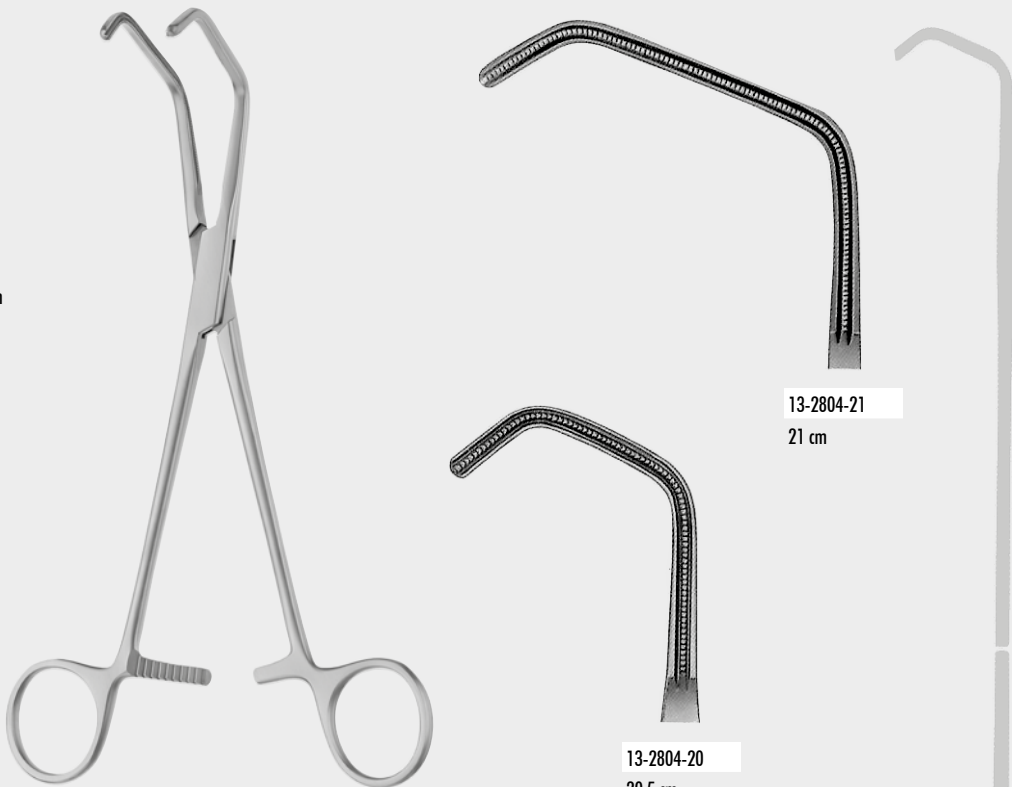

DEBAKEY BECK  
13-2804-20 - 13-2804-21

13-2804-21  
21 cm

13-2804-20  
20,5 cm



13-2709-17

ATRAUMA



DEBAKEY



Präparier- und Ligaturklemmen  
Dissecting and Ligature Clamps  
Pincès à dissection et passe-fil  
Pinzas de disección y para ligaduras  
Pinze per dissezione e per legature

CARDIOVASCULAR  
INSTRUMENTE

CARDIOVASCULAR  
INSTRUMENTS

INSTRUMENTS  
CARDIOVASCULAIRES

PINZAS VASCULARES  
ATRAUMÁTICAS

INSTRUMENTOS  
CARDIOVASCULARES

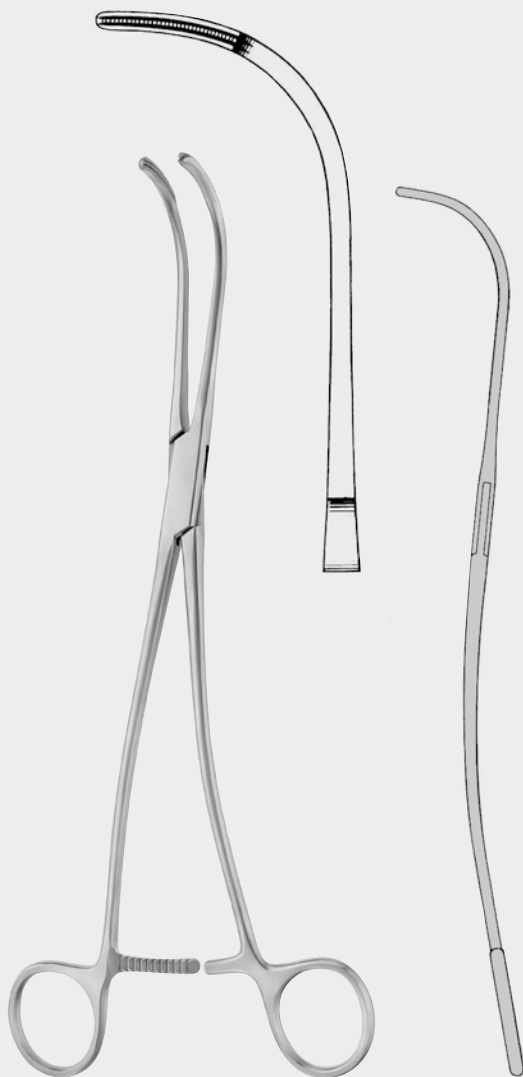

DEBAKEY  
13-2805-24  
24 cm



DEBAKEY  
13-2807-24  
24 cm

ZEPF<sup>®</sup>  
**α**  
INSTRUMENTS

13-2807-24

27



ATRAUMA



DEBAKEY

Coarctationsklemmen  
Coarctation Clamps  
Pinces à coarctacion  
Pinzas para coarctación  
Pinze per coarctazione

CARDIOVASCULAR  
INSTRUMENTE

CARDIOVASCULAR  
INSTRUMENTS

INSTRUMENTS  
CARDIOVASCULAIRES

INSTRUMENTOS  
CARDIOVASCULARES

STRUMENTI  
CARDIOVASCOLARI



POTTS  
13-2808-21 - 13-2808-31



13-2808-21  
21 cm



13-2808-23  
23 cm



13-2808-27  
27 cm



13-2808-31  
31 cm



POTTS  
13-2809-21 - 13-2809-31



13-2809-21  
21 cm



13-2809-23  
23 cm



13-2809-27  
27 cm



13-2809-31  
31 cm

ZEPF®  
INSTRUMENTS

13-2808-21

28

ATRAUMA



DEBAKEY



DERRA  
13-2901-16 - 13-2901-18

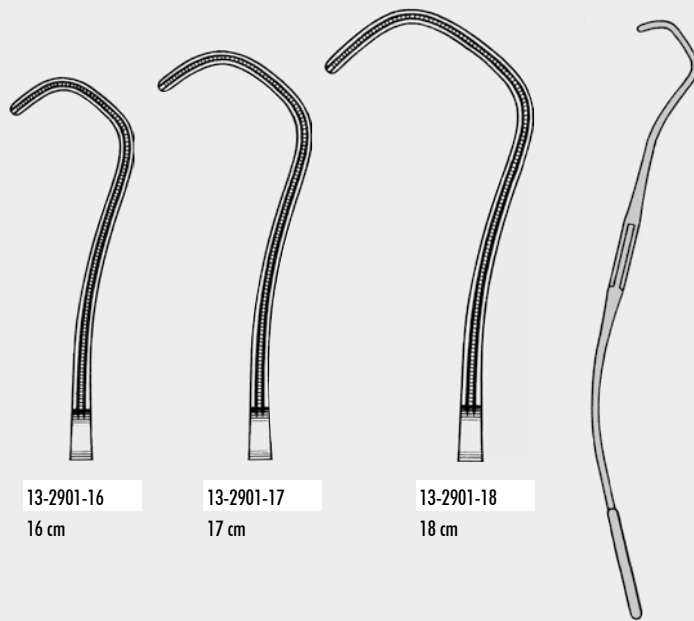

13-2901-16  
16 cm

13-2901-17  
17 cm

13-2901-18  
18 cm

Anastomosenklemmen, Kindergrößen  
Anastomosis Clamps, Pediatric  
Pinces à anastomose, pédiatriques  
Pinzas para anastomosis, pediátricas  
Pinze per anastomosi, pediatriche

CARDIOVASCULAR  
INSTRUMENTE

CARDIOVASCULAR  
INSTRUMENTS

INSTRUMENTS  
CARDIOVASCULAIRES

PINZAS VASCULARES  
ATRAUMÁTICAS

INSTRUMENTOS  
CARDIOVASCULARES

Coarctationsklemmen  
Coarctation Clamps  
Pinces à coarctation  
Pinzas para coarctación  
Pinze per coarctazione



DEBAKEY  
13-3002-16  
16 cm

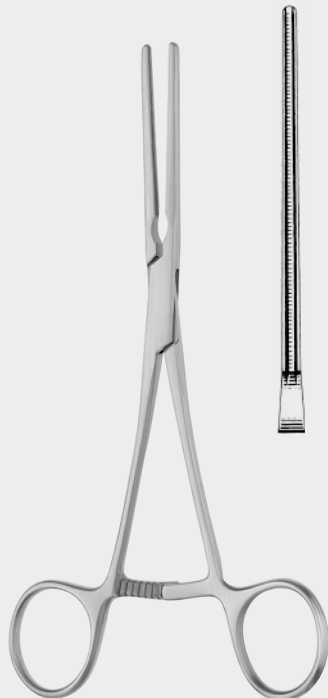

DEBAKEY  
13-3002-17  
17 cm

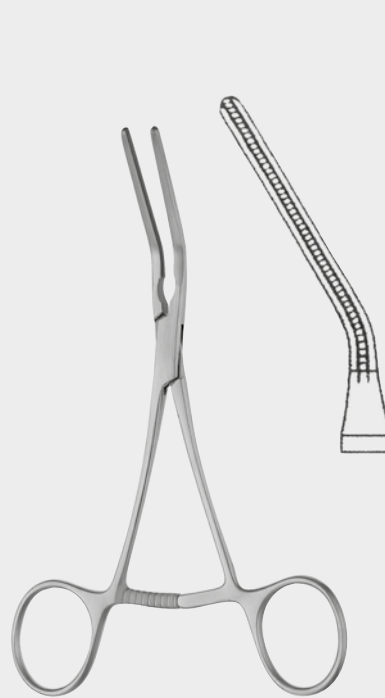

DEBAKEY  
13-3003-15  
15,5 cm

ZEPF<sup>®</sup>  
INSTRUMENTS

13-3003-15



ATRAUMA



DEBAKEY

Anastomosenklemmen  
Anastomosis Clamps  
Pinces à anastomose  
Pinzas para anastomosis  
Pinze per anastomosi

Coarctationsklemmen  
Coarctation Clamps  
Pinces à coarctacion  
Pinzas para coarctación  
Pinze per coarctazione

CARDIOVASCULAR  
INSTRUMENTE

CARDIOVASCULAR  
INSTRUMENTS

INSTRUMENTS  
CARDIOVASCULAIRES

INSTRUMENTOS  
CARDIOVASCULARES

STRUMENTI  
CARDIOVASCOLARI



DEBAKEY  
13-3005-15  
15,5 cm



DEBAKEY  
13-3007-17  
17 cm



13-3009-16  
16 cm

13-3009-17  
17 cm

DEBAKEY  
13-3009-16 - 13-3009-17



13-3005-15

30

ATRAUMA



DEBAKEY



Coarctationsklemmen  
Coarctation Clamps  
Pinces à coarctation  
Pinzas para coarctación  
Pinze per coarctazione

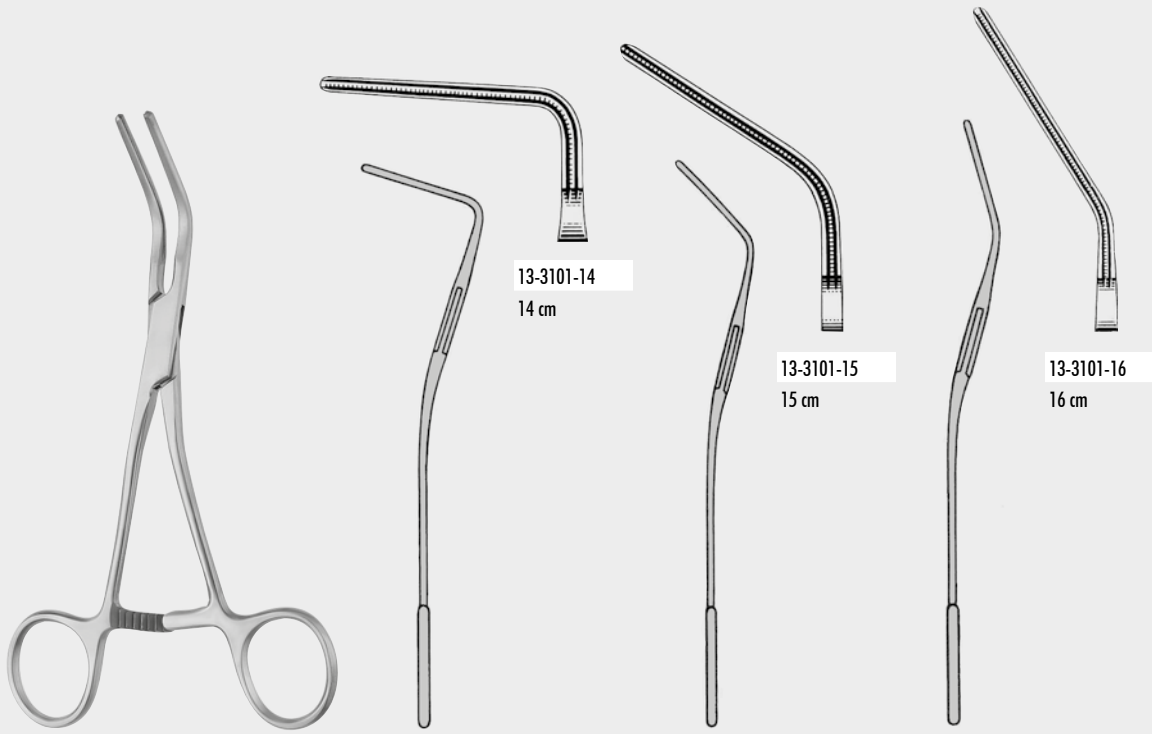

13-3101-14  
14 cm

13-3101-15  
15 cm

13-3101-16  
16 cm

DEBAKEY  
13-3101-14 - 13-3101-16

CARDIOVASCULAR  
INSTRUMENTE

CARDIOVASCULAR  
INSTRUMENTS

INSTRUMENTS  
CARDIOVASCULAIRES

PINZAS VASCULARES  
ATRAUMÁTICAS

INSTRUMENTOS  
CARDIOVASCULARES

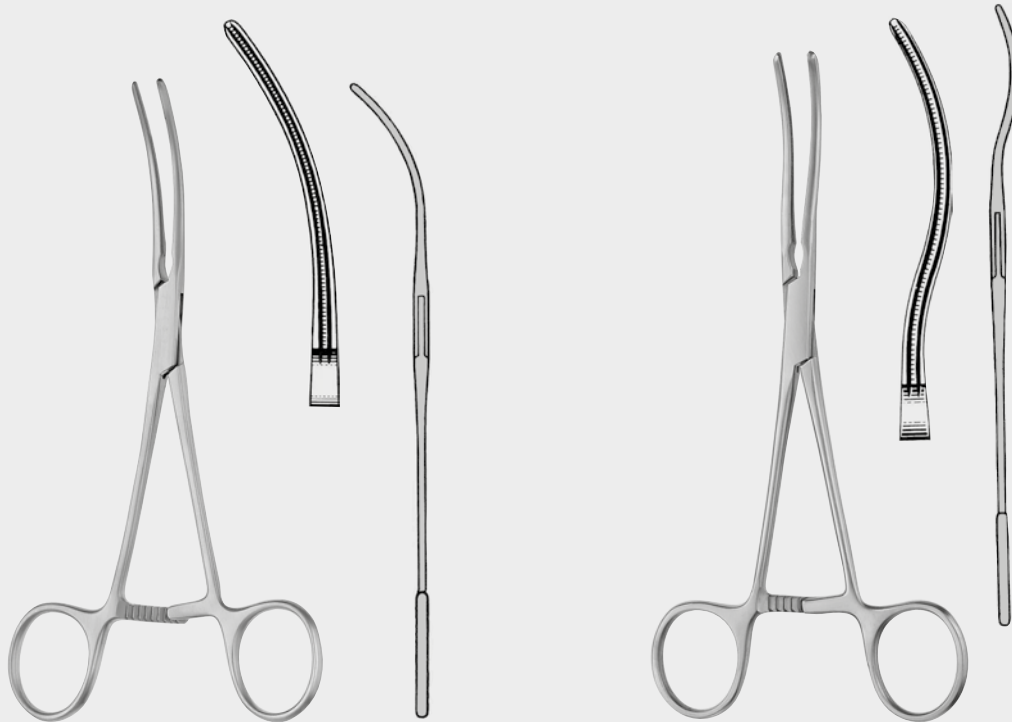

GLOVER  
13-3201-17  
17 cm

GLOVER  
13-3203-17  
17 cm



13-3203-17



**ATRAUMA**



DEBAKEY

Anastomosenklemmen  
Anastomosis Clamps  
Pinces à anastomose  
Pinzas para anastomosis  
Pinze per anastomosi



13-3209-01  
18 cm

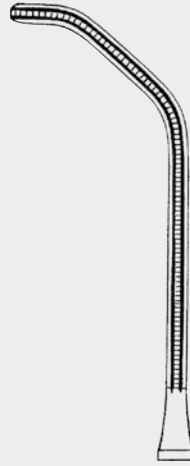

13-3209-02  
18 cm

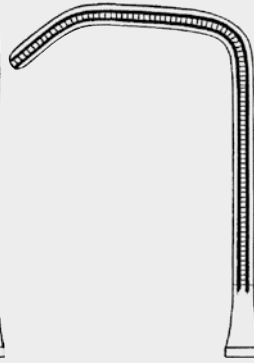

13-3209-03  
16,5 cm

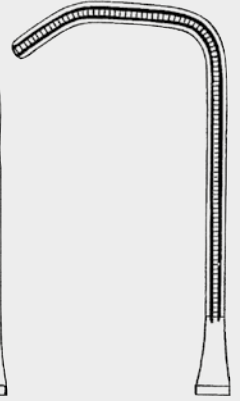

13-3209-04  
16,5 cm

**CARDIOVASCULAR INSTRUMENTE**

DEBAKEY REYNOLDS  
13-3209-01 - 13-3209-04

**CARDIOVASCULAR INSTRUMENTS**

**INSTRUMENTS CARDIOVASCULAIRES**

**INSTRUMENTOS CARDIOVASCULARES**

**STRUMENTI CARDIOVASCOLARI**

Aortaklemmen  
Aortic Clamp  
Pince-clamp à aorte  
Pinza clamp para aorta  
Pinza per aorta



SUBRAMANIAN MINIATURE  
13-3301-15  
15 cm

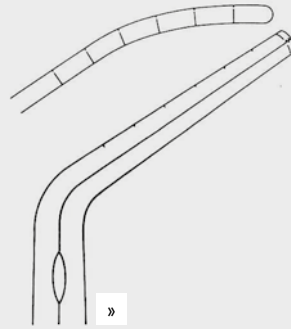

13-3303-16  
16 cm

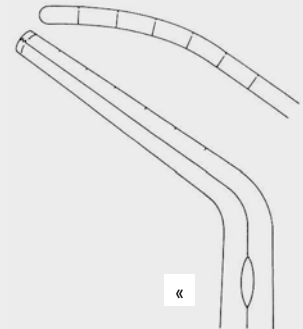

13-3305-16  
16 cm



SUBRAMANIAN  
13-3303-16 - 13-3305-16



13-3209-01





ATRAUMA



DEBAKEY

Aortaklemmen  
Aortic Clamp  
Pince-clamp à aorte  
Pinza clamp para aorta  
Pinza per aorta



OCHSNER  
13-3307-23 - 13-3307-26



13-3307-23  
23 cm



13-3307-26  
26 cm



DIETRICH  
13-3309-21  
21 cm

CARDIOVASCULAR  
INSTRUMENTE

CARDIOVASCULAR  
INSTRUMENTS

INSTRUMENTS  
CARDIOVASCULAIRES

PINZAS VASCULARES  
ATRAUMÁTICAS

INSTRUMENTOS  
CARDIOVASCULARES



13-3309-21



**ATRAUMA**



DEBAKEY

Ligaturklemmen  
Ligature Clamps  
Pinces à passe-fil  
Pinzas para ligaduras  
Pinze per legature

Anastomosenklemmen  
Anastomosis Clamps  
Pinces à anastomose  
Pinzas para anastomosis  
Pinze per anastomosi

Ligaturklemmen  
Ligature Clamps  
Pinces à passe-fil  
Pinzas para ligaduras  
Pinze per legature

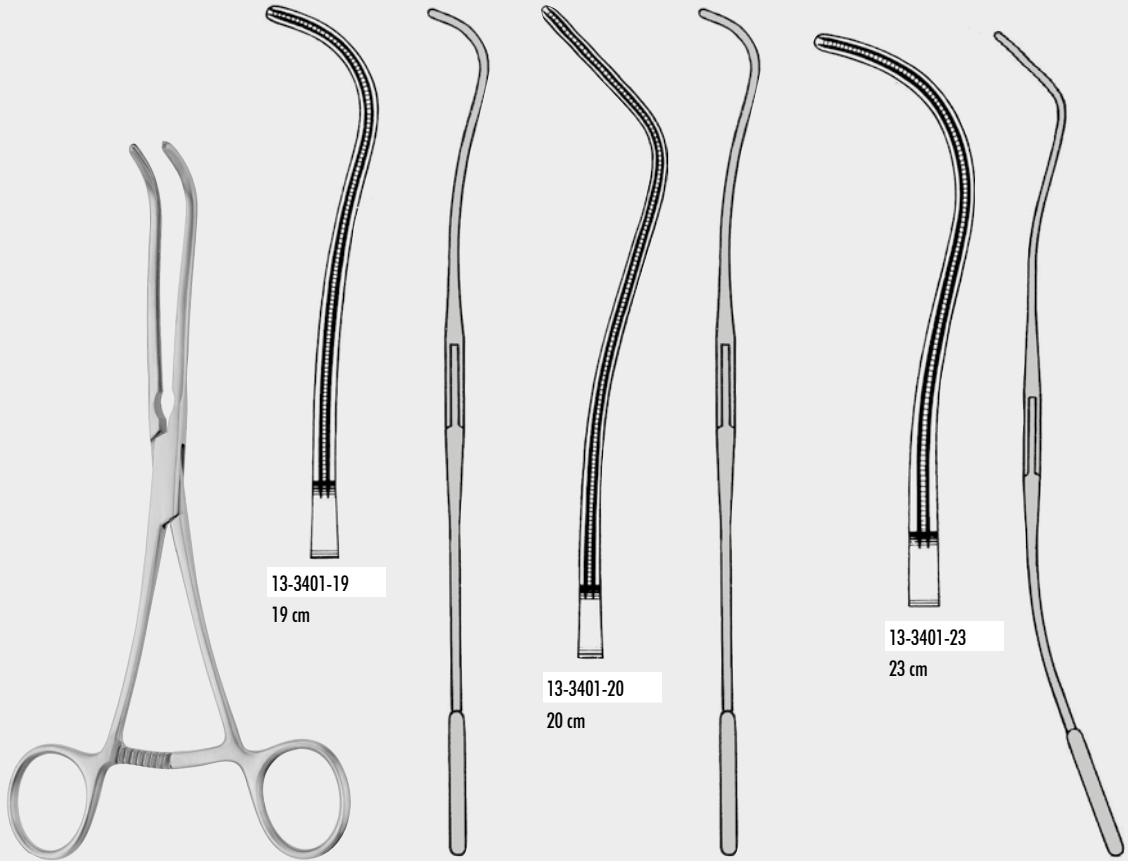

13-3401-19  
19 cm

13-3401-20  
20 cm

13-3401-23  
23 cm

DEBAKEY  
13-3401-19 - 13-3401-23

CARDIOVASCULAR  
INSTRUMENTE

CARDIOVASCULAR  
INSTRUMENTS

INSTRUMENTS  
CARDIOVASCULAIRES

INSTRUMENTOS  
CARDIOVASCULARES

STRUMENTI  
CARDIOVASCOLARI

Carotis-Shuntklemmen  
Carotid Shunt Clamps  
Pinces pour carotide  
Pinzas para shunt carótido  
Pinze carotis

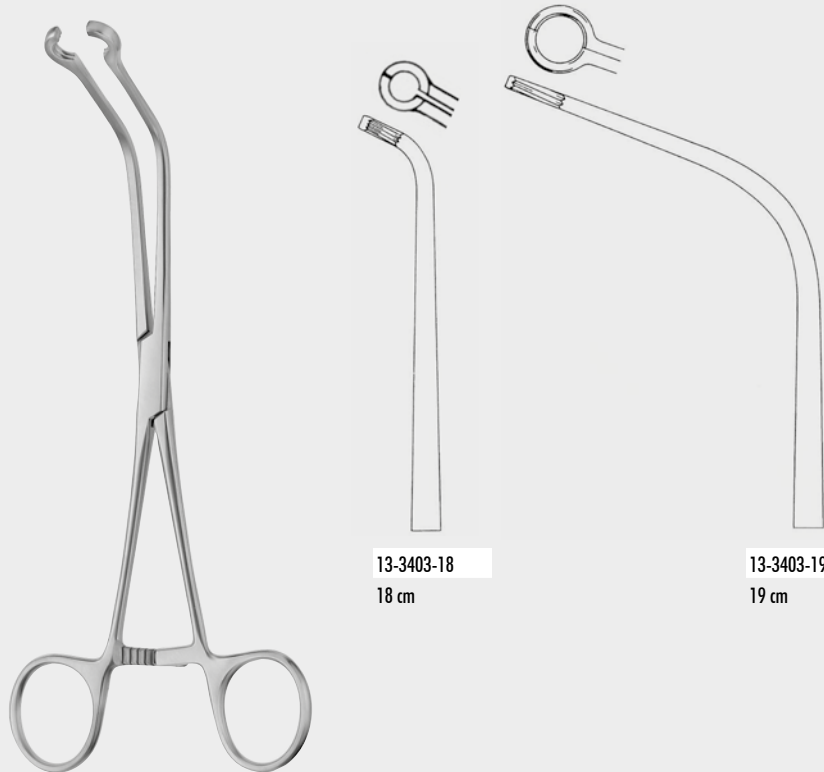

13-3403-18  
18 cm

13-3403-19  
19 cm

JAVID  
13-3403-18 - 13-3403-19



13-3401-19



Profunda-Klemmen  
Profunda Clamps  
Pinces-clamps pour profunda  
Pinzas clamps para profunda  
Pinze per profunda



GREGORY  
13-3409-14 - 13-3409-18

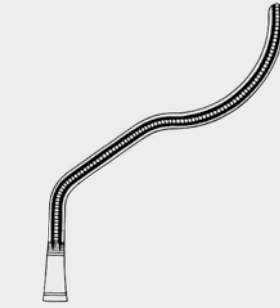

13-3409-14  
14 cm

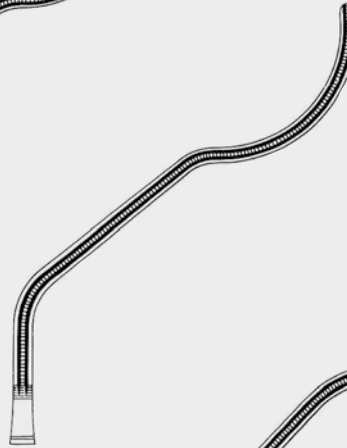

13-3409-16  
16 cm

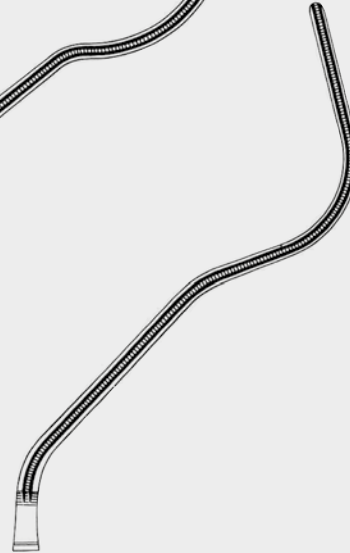

13-3409-18  
18 cm

CARDIOVASCULAR  
INSTRUMENTE

CARDIOVASCULAR  
INSTRUMENTS

INSTRUMENTS  
CARDIOVASCULAIRES

PINZAS VASCULARES  
ATRAUMÁTICAS

INSTRUMENTOS  
CARDIOVASCULARES

Bulldogklemmen mit Ringgriff  
Ring Bulldog clamps  
Clamps Bulldog  
Clamps Bulldog  
Pinze Bulldog

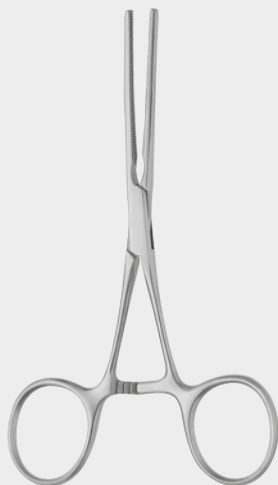

COOLEY  
13-3500-13 - 13-3501-13



13-3500-13  
12,5 cm

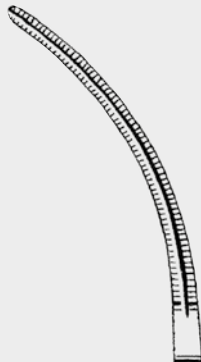

13-3501-13  
12,5 cm

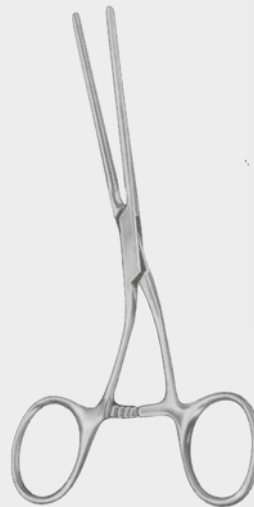

COOLEY  
13-3503-13  
13,5 cm



15°



13-3503-13



ATRAUMA



COOLEY

Bulldogklemmen mit Ringgriff  
Ring Bulldog clamps  
Clamps Bulldog  
Clamps Bulldog  
Pinze Bulldog

CARDIOVASCULAR  
INSTRUMENTE

CARDIOVASCULAR  
INSTRUMENTS

INSTRUMENTS  
CARDIOVASCULAIRES

INSTRUMENTOS  
CARDIOVASCULARES

STRUMENTI  
CARDIOVASCOLARI

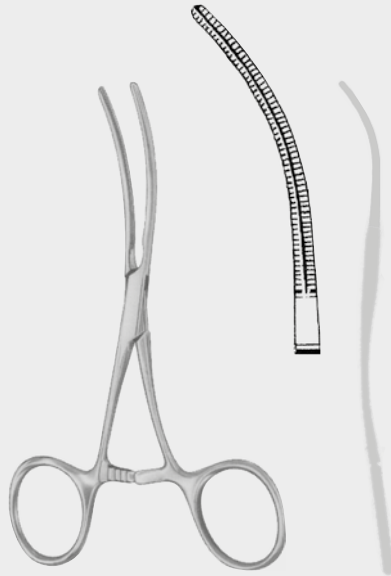

COOLEY  
13-3505-13  
13,0 cm



COOLEY  
13-3507-12  
12,5 cm



COOLEY  
13-3509-10  
10,5 cm

COOLEY  
13-3601-12  
12,5 cm

COOLEY  
13-3603-13  
13,5 cm



13-3505-13



Katheterklemmen  
Catheter clamps  
Pinces pour sondes  
Pinzas para catéteres  
Pinze per cateteri



13-3701-24  
16 cm  
24 Charr.



13-3701-26  
16 cm  
26 Charr.



13-3703-28  
20 cm  
28 Charr.



13-3703-30  
20 cm  
30 Charr.



13-3703-32  
20 cm  
32 Charr.



13-3703-36  
20 cm  
36 Charr.



COOLEY

13-3701-24 - 13-3703-36

CARDIOVASCULAR  
INSTRUMENTE

CARDIOVASCULAR  
INSTRUMENTS

INSTRUMENTS  
CARDIOVASCULAIRES

PINZAS VASCULARES  
ATRAUMÁTICAS

INSTRUMENTOS  
CARDIOVASCULARES



ATRAUMA



COOLEY

Coarctationsklemmen  
Coarctation Clamps  
Pinces à coarctacion  
Pinzas para coarctación  
Pinze per coarctazione

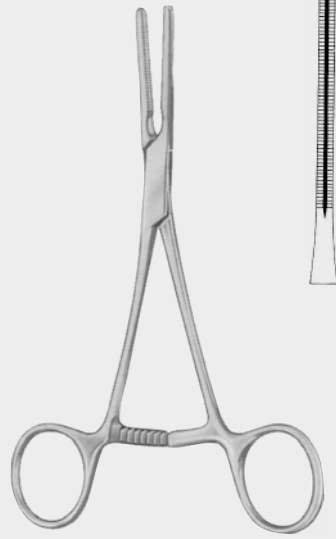

COOLEY  
13-3706-14  
14 cm

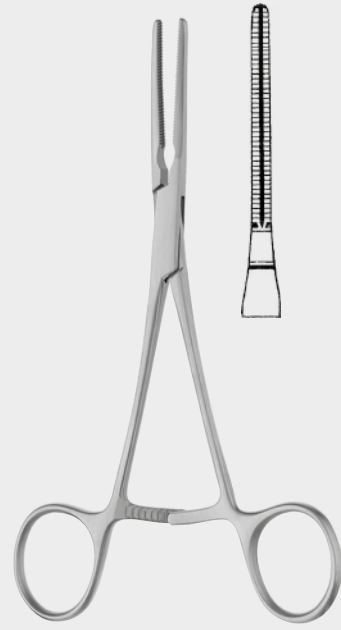

COOLEY  
13-3706-16  
16 cm

CARDIOVASCULAR  
INSTRUMENTE

CARDIOVASCULAR  
INSTRUMENTS

INSTRUMENTS  
CARDIOVASCULAIRES

INSTRUMENTOS  
CARDIOVASCULARES

STRUMENTI  
CARDIOVASCOLARI

Neonatal- und Kinderklemmen, extra feine Modelle  
Neonatal and Childrens Clamps, extra delicate patterns  
Pinces-clamps pour des nouveaux-nés et des enfants, modèles très fins  
Pinzas clamps para recién nacidos y niños, modelos muy finos  
Pinze pediatriche, modelli molto fini



COOLEY  
13-3707-16  
16 cm



COOLEY  
13-3709-14  
14 cm



COOLEY  
13-3800-14  
14 cm



13-3706-14

ATRAUMA



COOLEY

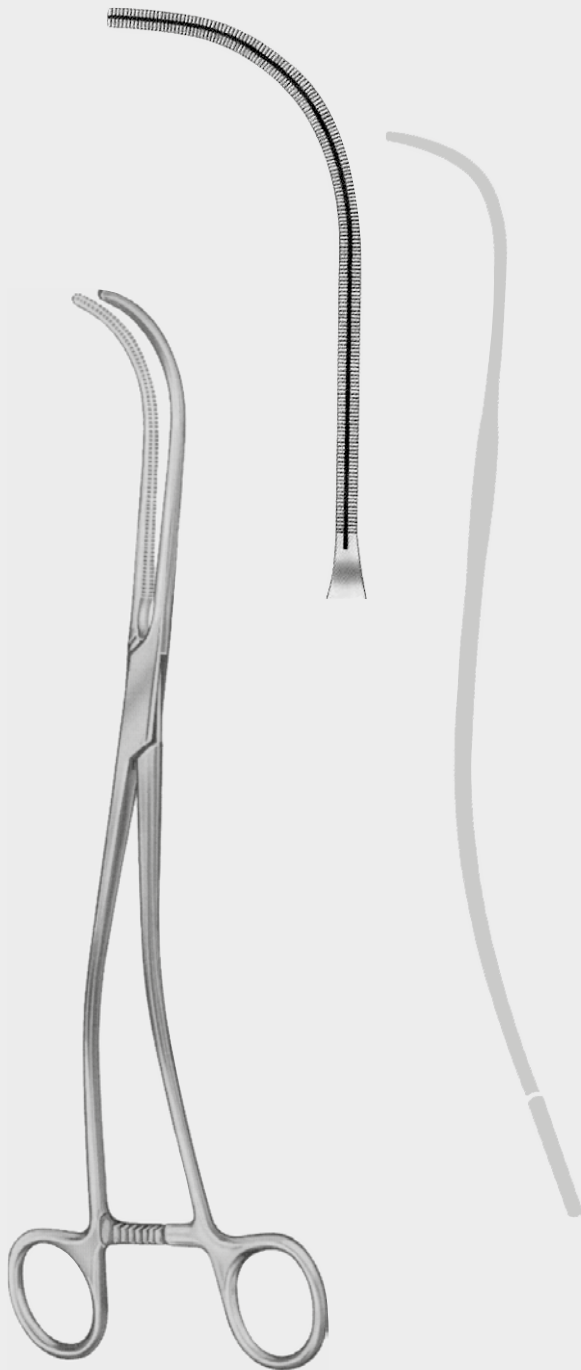

COOLEY  
13-4005-27  
27 cm

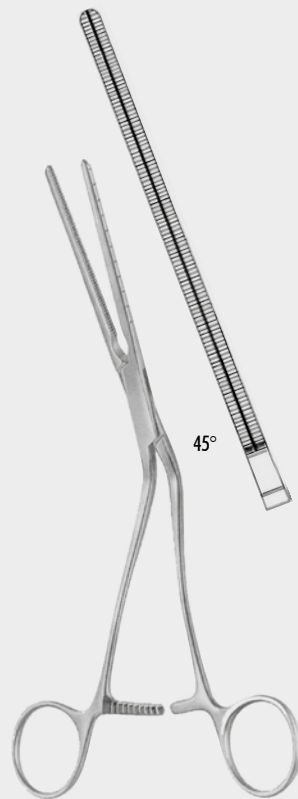

COOLEY  
22,5 cm 13-4007-22  
27,0 cm 13-4007-27

Atraumatische Mehrzweckklemmen  
Atraumatic Multi-Purpose Clamps  
Pinces-clamps polyvalentes  
Pinzas clamps para usos varios  
Pinze atraumatiche per diversi usi

CARDIOVASCULAR  
INSTRUMENTE

CARDIOVASCULAR  
INSTRUMENTS

INSTRUMENTS  
CARDIOVASCULAIRES

PINZAS VASCULARES  
ATRAUMÁTICAS

INSTRUMENTOS  
CARDIOVASCULARES

Iliaca-Klemmen  
Iliac Clamps  
Pinces-clamps à iliaque  
Pinzas clamps para iliaca  
Pinze per iliaca



13-4007-27



ATRAUMA



COOLEY

Coarctationsklemmen  
Coarction Clamps  
Pinces à coarctacion  
Pinzas para coarctación  
Pinze per coarctazione



13-4100-17  
17 cm



13-4101-17  
17 cm

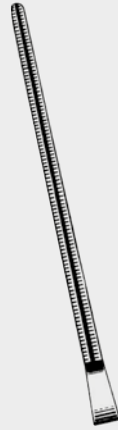

13-4107-17  
17 cm

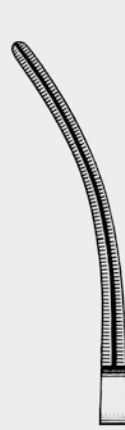

13-4109-17  
17 cm



CARDIOVASCULAR  
INSTRUMENTE

CARDIOVASCULAR  
INSTRUMENTS

INSTRUMENTS  
CARDIOVASCULAIRES

INSTRUMENTOS  
CARDIOVASCULARES

STRUMENTI  
CARDIOVASCOLARI

Anastomosenklemmen  
Anastomosis Clamps  
Pinces à anastomose  
Pinzas para anastomosis  
Pinze per anastomosi

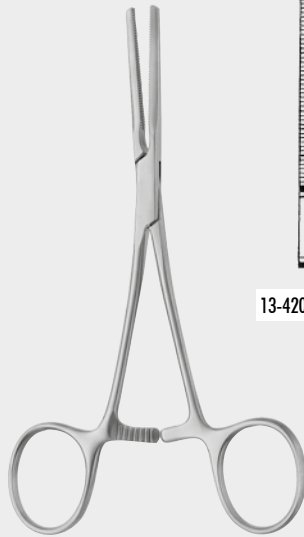

13-4200-14



13-4201-14

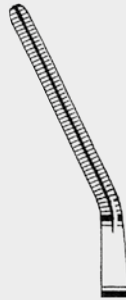

COOLEY  
13-4200-14 - 13-4201-14  
14 cm



COOLEY  
13-4203-14  
14 cm



13-4100-17

40





Neonatal- und Kinderklemmen  
 Neonatal and Children Clamps  
 Pincés-clamps pour des nouveaux-nés et des enfants  
 Pinzas clamps para recién nacidos y niños  
 Pinze pediatriche

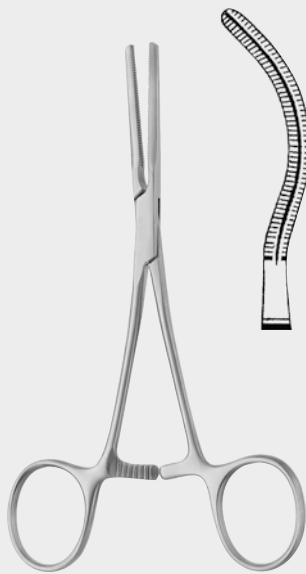

COOLEY  
 13-4205-14  
 14 cm



90°  
 13-4301-90  
 15 cm



CARDIOVASCULAR  
 INSTRUMENTE

CARDIOVASCULAR  
 INSTRUMENTS

INSTRUMENTS  
 CARDIOVASCULAIRES

PINZAS VASCULARES  
 ATRAUMÁTICAS

INSTRUMENTOS  
 CARDIOVASCULARES

Atraumatische Mehrzweckklemmen  
 Atraumatic Multi-Purpose Clamps  
 Pincés-clamps polyvalentes  
 Pinzas clamps para usos varios  
 Pinze atraumatiche per diversi usi

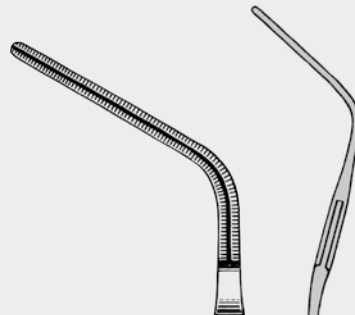

45°  
 13-4301-45  
 15,5 cm

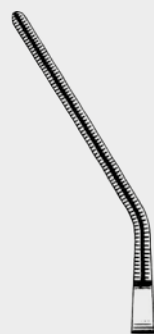

25°  
 13-4301-25  
 17 cm



COOLEY  
 13-4301-25 - 13-4301-90



ATRAUMA



COOLEY

CARDIOVASCULAR  
INSTRUMENTE

CARDIOVASCULAR  
INSTRUMENTS

INSTRUMENTS  
CARDIOVASCULAIRES

INSTRUMENTOS  
CARDIOVASCULARES

STRUMENTI  
CARDIOVASCOLARI

Neonatal- und Kinderklemmen  
Neonatal and Children Clamps  
Pinces-clamps pour des nouveaux-nés et des enfants  
Pinzas clamps para recién nacidos y niños  
Pinze pediatriche

Anastomosenklemmen  
Anastomosis Clamps  
Pinces à anastomose  
Pinzas para anastomosis  
Pinze per anastomosi

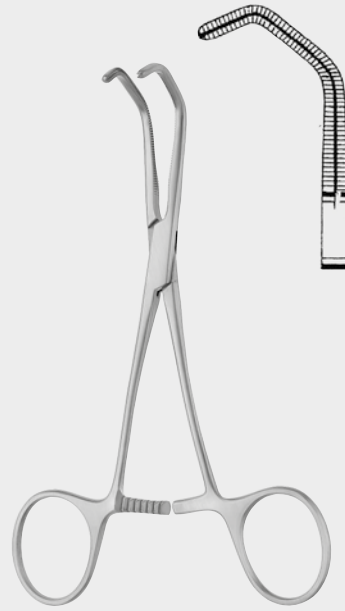

COOLEY  
13-4303-14  
14 cm



COOLEY DERRA

13-4401-16  
16 cm

13-4401-17  
17 cm

13-4401-18  
18 cm

**ZEPF**<sup>®</sup>  
**α**  
INSTRUMENTS

13-4303-14

42



COOLEY  
13-4407-17 - 13-4409-17

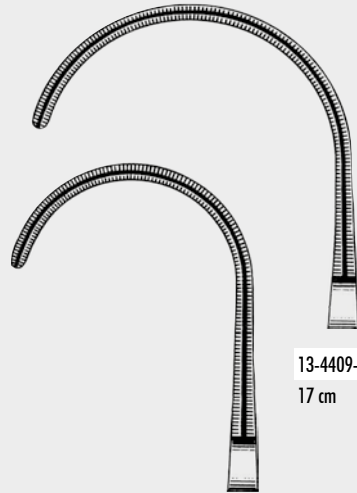

13-4409-17  
17 cm

13-4407-17  
16 cm



Anastomosenklemmen  
Anastomosis Clamps  
Pinces à anastomose  
Pinzas para anastomosis  
Pinze per anastomosi

CARDIOVASCULAR  
INSTRUMENTE

CARDIOVASCULAR  
INSTRUMENTS

INSTRUMENTS  
CARDIOVASCULAIRES

PINZAS VASCULARES  
ATRAUMÁTICAS

INSTRUMENTOS  
CARDIOVASCULARES



COOLEY  
13-4500-16 - 13-4505-17

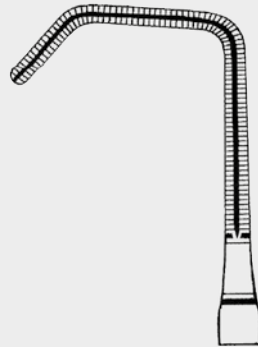

13-4500-16  
16,5 cm

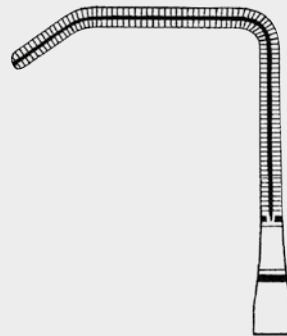

13-4501-16  
16,5 cm

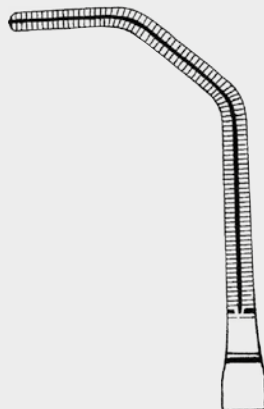

13-4503-16  
17,5 cm

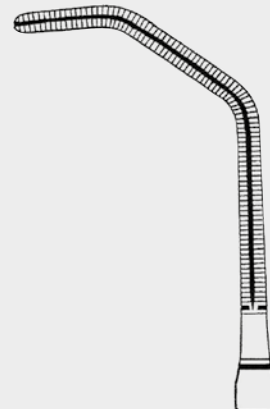

13-4505-17  
17,5 cm



ATRAUMA



COOLEY

Atraumatische Mehrzweckklemmen  
Atraumatic Multi-Purpose Clamps  
Pinces-clamps polyvalentes  
Pinzas clamps para usos varios  
Pinze atraumatiche per diversi usi

CARDIOVASCULAR  
INSTRUMENTE

CARDIOVASCULAR  
INSTRUMENTS

INSTRUMENTS  
CARDIOVASCULAIRES

INSTRUMENTOS  
CARDIOVASCULARES

STRUMENTI  
CARDIOVASCOLARI

Carotis-Shuntklemmen  
Carotid Shunt Clamps  
Pinces pour carotide  
Pinzas para shunt carótido  
Pinze carotis



13-4507-17  
17 cm

COOLEY  
13-4601-17  
17 cm

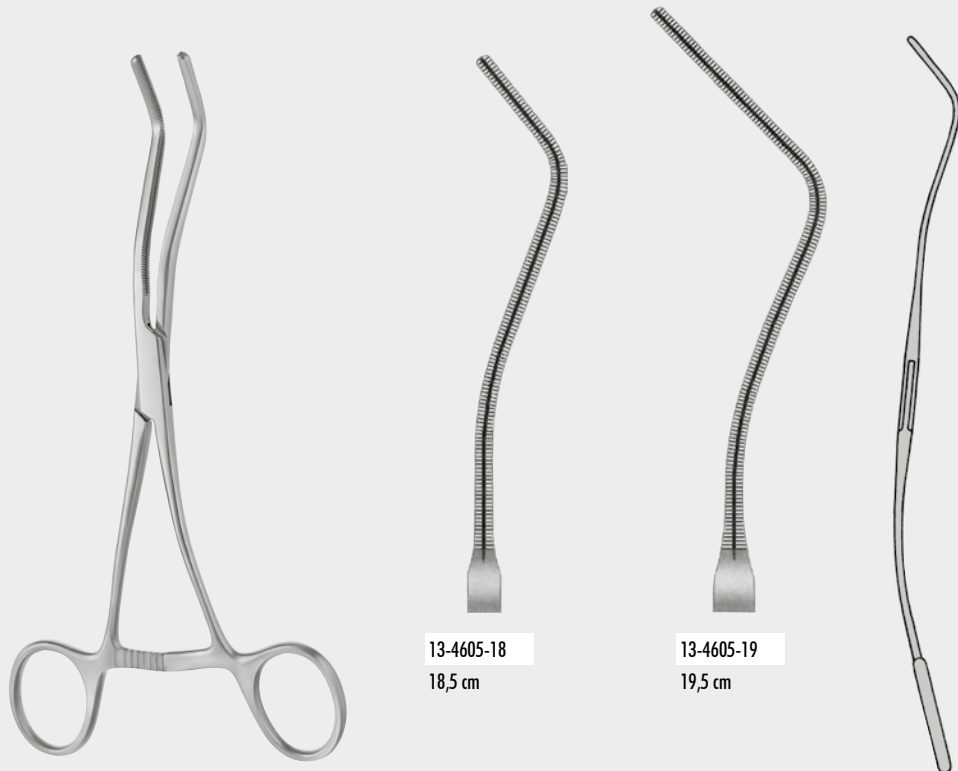

COOLEY  
13-4605-18 - 13-4605-19

13-4605-18  
18,5 cm

13-4605-19  
19,5 cm



13-4507-17

Carotis-Shuntklemmen  
Carotid Shunt Clamps  
Pincés pour carotide  
Pinças para shunt carótido  
Pinze carotis

Atraumatische Mehrzweckklemmen  
Atraumatic Multi-Purpose Clamps  
Pincés-clamps polyvalentes  
Pinças clamps para usos varios  
Pinze atraumatiche per diversi usi



COOLEY  
13-4605-26  
26 cm



COOLEY  
13-4607-27  
27,5 cm

CARDIOVASCULAR  
INSTRUMENTE

CARDIOVASCULAR  
INSTRUMENTS

INSTRUMENTS  
CARDIOVASCULAIRES

PINZAS VASCULARES  
ATRAUMÁTICAS

INSTRUMENTOS  
CARDIOVASCULARES



ATRAUMA



COOLEY

Atraumatische Gefäßklemmen  
Atraumatic Vascular Clamps  
Pinces vasculaires atraumatiques  
Pinzas vasculares atraumáticas  
Pinze vascolari atraumatiche

CARDIOVASCULAR  
INSTRUMENTE

CARDIOVASCULAR  
INSTRUMENTS

INSTRUMENTS  
CARDIOVASCULAIRES

INSTRUMENTOS  
CARDIOVASCULARES

STRUMENTI  
CARDIOVASCOLARI

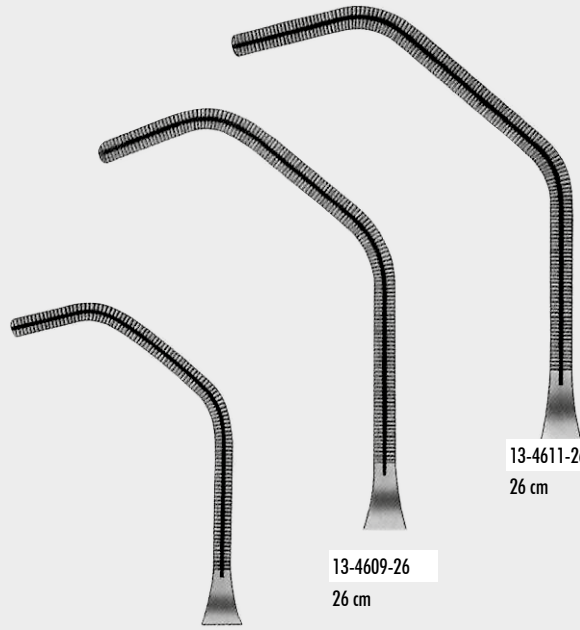

13-4611-26  
26 cm

13-4609-26  
26 cm

13-4609-20  
20,5 cm



COOLEY  
13-4609-20 - 13-4613-27

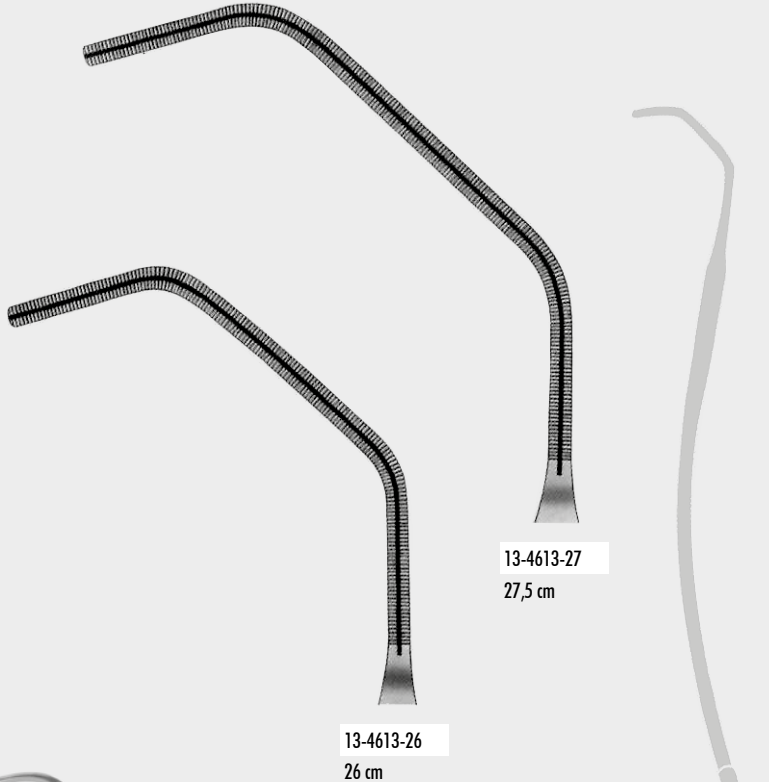

13-4613-27  
27,5 cm

13-4613-26  
26 cm

ZEPF®  
INSTRUMENTS

13-4609-20

46



Neonatal- und Kinderklemmen, extra feine Modelle  
 Neonatal and Children Clamps, extra delicate patterns  
 Pinces-clamps pour des nouveaux-nés et des enfants, modèles très fins  
 Pinzas clamps para recién nacidos y niños, modelos muy finos  
 Pinze pediatriche, modelli molto fini

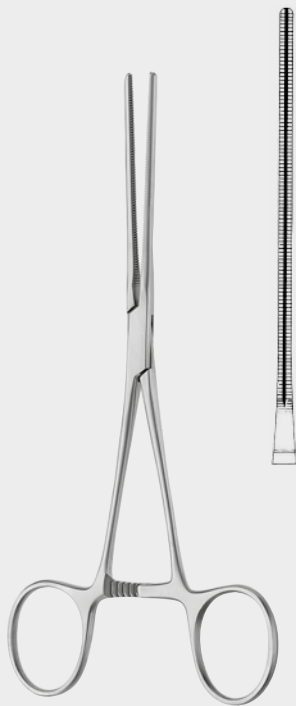

COOLEY  
 13-4620-16  
 16,5 cm

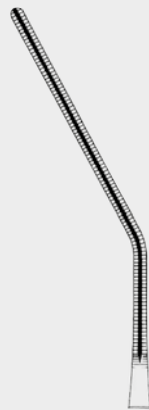

13-4621-16  
 16 cm

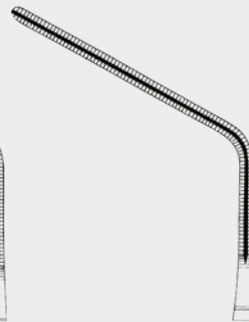

13-4623-16  
 15,5 cm



COOLEY  
 13-4621-16 - 13-4627-16

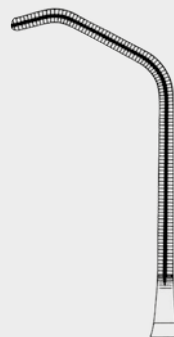

13-4625-16  
 15,5 cm



13-4627-16  
 16 cm

CARDIOVASCULAR  
 INSTRUMENTE

CARDIOVASCULAR  
 INSTRUMENTS

INSTRUMENTS  
 CARDIOVASCULAIRES

PINZAS VASCULARES  
 ATRAUMÁTICAS

INSTRUMENTOS  
 CARDIOVASCULARES



13-4627-16



ATRAUMA



CASTAÑEDA

Neonatal- und Kinderklemmen, extra feine Modelle  
 Neonatal and Children Clamps, extra delicate patterns  
 Pinces-clamps pour des nouveaux-nés et des enfants, modèles très fins  
 Pinzas clamps para recién nacidos y niños, modelos muy finos  
 Pinze pediatriche, modelli molto fini



CASTAÑEDA

13-4800-13 - 13-4907-12

CARDIOVASCULAR INSTRUMENTE

CARDIOVASCULAR INSTRUMENTS

INSTRUMENTS CARDIOVASCULAIRES

INSTRUMENTOS CARDIOVASCULARES

STRUMENTI CARDIOVASCOLARI



13-4800-13  
13 cm

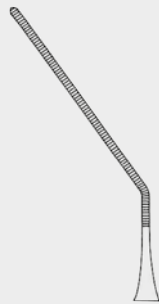

13-4803-13  
12,5 cm

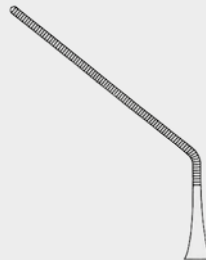

13-4805-13  
11,5 cm

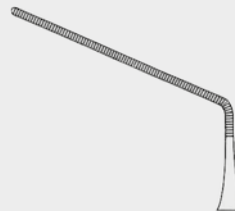

13-4807-13  
11,5 cm



13-4809-13  
11,5 cm

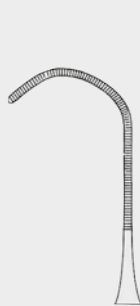

13-4901-11  
11,5 cm

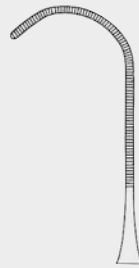

13-4903-12  
12 cm

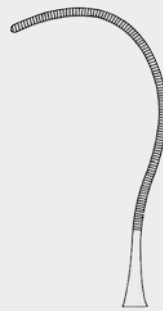

13-4905-12  
12 cm



13-4907-12  
12 cm



13-4800-13





**CASTAÑEDA 12 cm**  
13-4909-30 - 13-4909-45



30°  
13-4909-30

45°  
13-4909-45

Neonatal- und Kinderklammen, extra feine Modelle  
Neonatal and Children Clamps, extra delicate patterns  
Pinces-clamps pour des nouveaux-nés et des enfants, modèles très fins  
Pinzas clamps para recién nacidos y niños, modelos muy finos  
Pinze pediatriche, modelli molto fini

**CARDIOVASCULAR  
INSTRUMENTE**

**CARDIOVASCULAR  
INSTRUMENTS**

**INSTRUMENTS  
CARDIOVASCULAIRES**

**PINZAS VASCULARES  
ATRAUMÁTICAS**

**INSTRUMENTOS  
CARDIOVASCULARES**



**CASTAÑEDA 15,5 cm**  
13-4911-15 - 13-4911-50



13-4911-15  
15 mm

13-4911-18  
18 mm

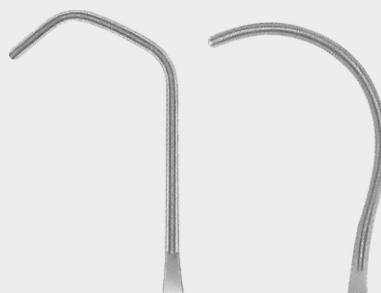

13-4911-23  
23 mm

13-4911-50  
50 mm

Neonatal- und Kinderklammen, extra feine Modelle  
Neonatal and Children Clamps, extra delicate patterns  
Pinces-clamps pour des nouveaux-nés et des enfants, modèles très fins  
Pinzas clamps para recién nacidos y niños, modelos muy finos  
Pinze pediatriche, modelli molto fini



ATRAUMA



COOLEY

Neonatal- und Kinderklemmen, extra feine Modelle  
 Neonatal and Children Clamps, extra delicate patterns  
 Pincés-clamps pour des nouveaux-nés et des enfants, modèles très fins  
 Pinzas clamps para recién nacidos y niños, modelos muy finos  
 Pinze pediatriche, modelli molto fini

CARDIOVASCULAR INSTRUMENTE

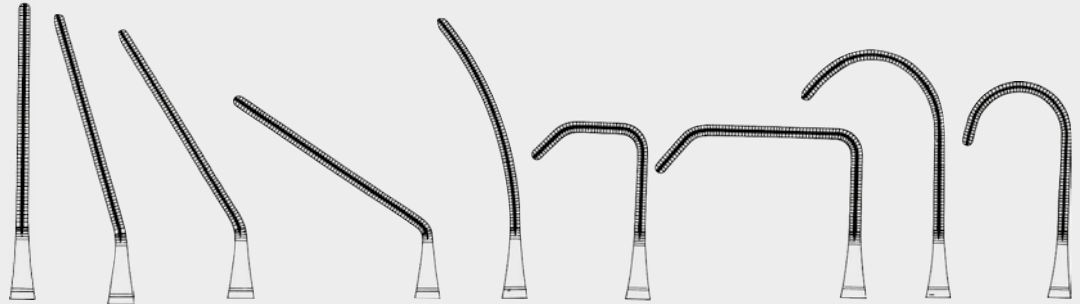

CARDIOVASCULAR INSTRUMENTS

	Fig. 1	Fig. 2	Fig. 3	Fig. 4	Fig. 5	Fig. 6	Fig. 7	Fig. 8	Fig. 9
A	13-5002-01	13-5002-02	13-5002-03	13-5002-04	13-5002-05	13-5002-06	13-5002-07	13-5002-08	13-5002-09
B	13-5003-01	13-5003-02	13-5003-03	13-5003-04	13-5003-05	13-5003-06	13-5003-07	13-5003-08	13-5003-09
C	13-5005-01	13-5005-02	13-5005-03	13-5005-04	13-5005-05	13-5005-06	13-5005-07	13-5005-08	13-5005-09
	14 cm	14 cm	14 cm	13 cm	14 cm	13,5 cm	14 cm	13,5 cm	13 cm

INSTRUMENTS CARDIOVASCULAIRES

INSTRUMENTOS CARDIOVASCULARES

STRUMENTI CARDIOVASCOLARI



COOLEY  
13-5002-01 - 13-5005-09



A



B



C



13-5002-01



Präparier- und Ligaturklemmen  
Dissecting and Ligature Clamps  
Pinces à dissection et passe-fil  
Pinzas de disección y para ligaduras  
Pinze per dissezione e per legature

CARDIOVASCULAR  
INSTRUMENTE

CARDIOVASCULAR  
INSTRUMENTS

INSTRUMENTS  
CARDIOVASCULAIRES

PINZAS VASCULARES  
ATRAUMÁTICAS

INSTRUMENTOS  
CARDIOVASCULARES



DEBAKEY RUMEL  
13-5201-01 - 13-5201-02



13-5201-01  
25 cm



13-5201-02  
25 cm



DEBAKEY McQUIGG MIXER  
13-5205-21  
21 cm



ATRAUMA



DEBAKEY

Präparier- und Ligaturklemmen  
Dissecting and Ligature Clamps  
Pinces à dissection et passe-fil  
Pinzas de disección y para ligaduras  
Pinze per dissezione e per legature

CARDIOVASCULAR  
INSTRUMENTE

CARDIOVASCULAR  
INSTRUMENTS

INSTRUMENTS  
CARDIOVASCULAIRES

INSTRUMENTOS  
CARDIOVASCULARES

STRUMENTI  
CARDIOVASCOLARI



DEBAKEY MIXTER

13-5207-28

28,5 cm

**ZEPF**<sup>®</sup>  
**α**  
INSTRUMENTS

13-5207-28

52

To Order: Contact Cooper Medical Ltd - Freephone: 0800 800 823 - Email: [admin@coopermedical.co.nz](mailto:admin@coopermedical.co.nz) - [www.coopermedical.co.nz](http://www.coopermedical.co.nz)



**CARDIOVASCULAR  
INSTRUMENTE**

---

**CARDIOVASCULAR  
INSTRUMENTS**

---

**INSTRUMENTS  
CARDIOVASCULAIRES**

---

**PINZAS VASCULARES  
ATRAUMÁTICAS**

---

**INSTRUMENTOS  
CARDIOVASCULARES**

**ZEPF<sup>®</sup>**  
**α**  
INSTRUMENTS

02-3200-19

53



CARDIOVASCULAR  
INSTRUMENTE

CARDIOVASCULAR  
INSTRUMENTS

INSTRUMENTS  
CARDIOVASCULAIRES

INSTRUMENTOS  
CARDIOVASCULARES

STRUMENTI  
CARDIOVASCOLARI





**CARDIOVASCULAR  
INSTRUMENTE**

**CARDIOVASCULAR  
INSTRUMENTS**

**INSTRUMENTS  
CARDIOVASCULAIRES**

**PINZAS VASCULARES  
ATRAUMÁTICAS**

**INSTRUMENTOS  
CARDIOVASCULARES**



CARDIOVASCULAR  
INSTRUMENTE

CARDIOVASCULAR  
INSTRUMENTS

INSTRUMENTS  
CARDIOVASCULAIRES

INSTRUMENTOS  
CARDIOVASCULARES

STRUMENTI  
CARDIOVASCOLARI

**ZEPF**<sup>®</sup>  
**α**  
INSTRUMENTS  
TUTTLINGEN  
GERMANY

ZEPF MEDICAL INSTRUMENTS GMBH  
GUNNINGERSTR. 21 · D-78606 SEITINGEN-OBERFLACHT  
P.O.B. 4805 · D-78513 TUTTLINGEN  
FON: +49 (0) 7464 / 985060  
FAX: +49 (0) 7464 / 9850666  
E-MAIL: [info@zepf-medical-instruments.de](mailto:info@zepf-medical-instruments.de)  
[www.zepf-medical-instruments.de](http://www.zepf-medical-instruments.de)

To Order: Contact Co