

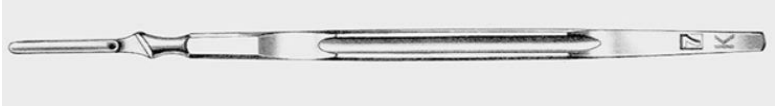















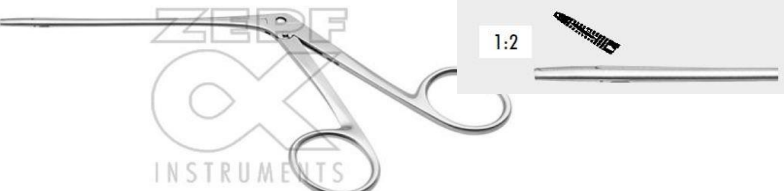





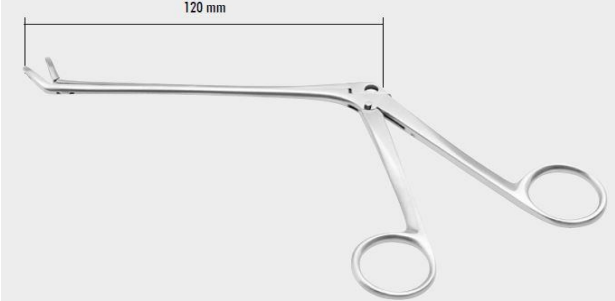
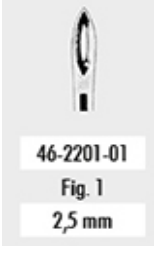

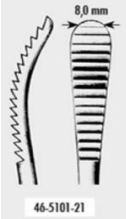

Functional Endoscopic Sinus Surgery (FESS) full Instrument Set

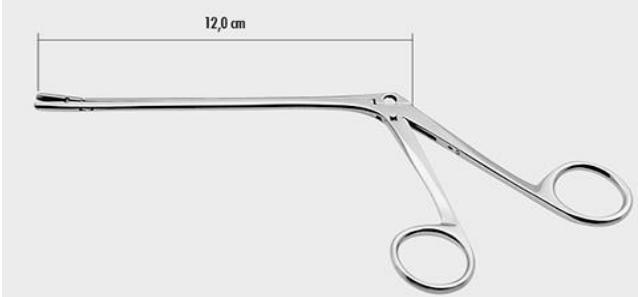
Code	Description	
46-1102-03	Vienna Mod. nasal specul.adult	
06-1007-00	scalpel handle no. 7 16,5 cm	
44-7004-15	WULLSTEIN sickle knife 15,5cm	
74-6702	Antrum Ball Probe (Murphy probe) 230mm, 14mm curve depth, 2.5mm ball	
84-2303-18	Double ended maxillary ostium seeker, 2.5mm/1.5mm ball ends 18cm	

46-3007-35	HAJEK KOFLER punch 3,5 mm, back biting forceps 17cm - 360 degree rotating	
46-4105-18	FREER septum elevat.sharp/blunt 18cm	
46-4204-22	BOTTLE periosteal elevator 22 cm 4,5 mm/4,5 mm - sharp/blunt	
32-5304-17	VOLKMANN double curette sharp round/oval \varnothing 9,1 mm/7,8x13,5 mm 17 cm	
44-2603-08	HARTMANN ear forceps 1x2 teeth 8.5cm, light pattern	
44-2603-14	HARTMANN ear forceps 1x2 teeth 14cm	
08-2841-14	METZENBAUM scissors serrated, curved 14 cm	

08-2111-15	KAYE scissor 15cm TC Serr. cutting edge, curved	 <p>ZEPF INSTRUMENTS</p>
46-2201-02	WEIL BLAKESLEY nasal forcps.12cm f.2 3.6 mm  <p>46-2201-02 Fig. 2 3,6 mm</p>	 <p>ZEPF INSTRUMENTS</p>
46-2209-02	WEIL BLAKESLEY forceps 45 degree up Fig. 2 - 3.6mm	 <p>120 mm</p>
46-2201-01	WEIL BLAKESLEY forcps.12cm f.1 - 2.5 mm	 <p>46-2201-01 Fig. 1 2,5 mm</p>  <p>ZEPF INSTRUMENTS</p>
44-3507-40	paediatric ear fcps.micro serr.upwr.d.4mm	 <p>44-3507-40 4,0 mm</p>  <p>ZEPF INSTRUMENTS</p>

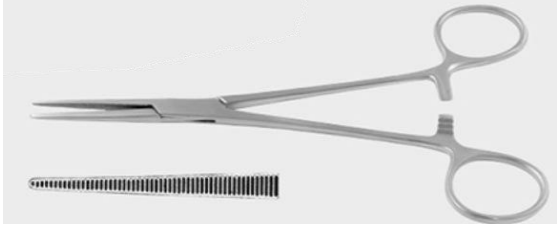
<p>46-5101-21</p>	<p>WIENER Glabella (AUFRICHT) nasal rasp 21cm - push/pull</p> 	
<p>46-2218-01</p>	<p>TAKAHASHI ethmoid forceps 4x10mm 16.5cm</p>	
<p>40-2905-08</p>	<p>FRAZIER asp.cann. 30° 8Fr.19cm</p>	
<p>40-2905-10</p>	<p>FRAZIER asp.cann. 30° 10Fr.19cm</p>	
<p>40-2905-12</p>	<p>FRAZIER asp.cann. 30° 12Fr.19cm</p>	
<p>44-1003-20</p>	<p>PLESTER suction cannula ø 2,0 mm Luer 19.5cm</p>	
<p>44-0991-10</p>	<p>BELLUCCI suction tube ø 4 mm 10,5 cm</p>	
<p>12-2602-16</p>	<p>CRILE RANKIN hemostat. forceps 16cm</p>	

44-2605-14

HARTMANN ear forceps lg. spoon, 14cm



46-3005-01

HAJEK KOFLER punch 3,5 mm upward 19cm

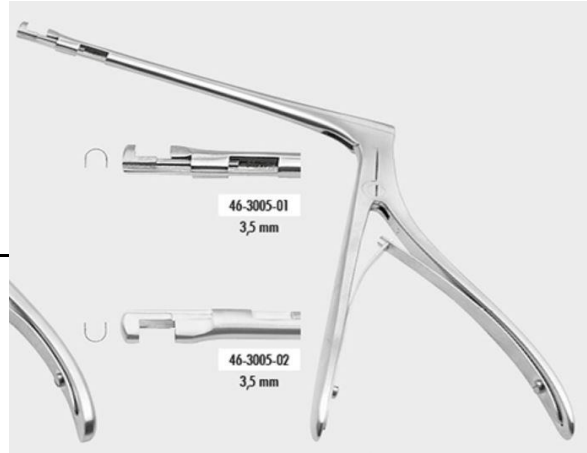

46-3005-02

HAJEK KOFLER punch 3,5 mm downward 19cm

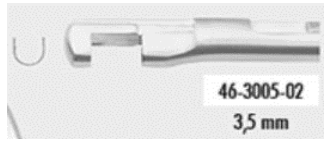

44-3100-40



BELLUCCI sciss.micro mini 4 mm

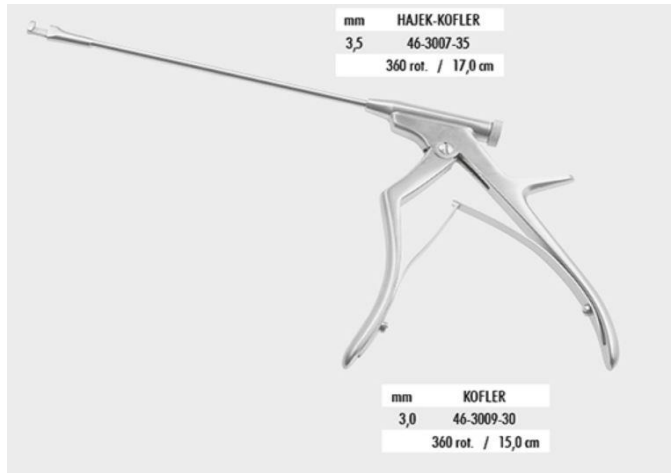

46-3009-30

KOFLER circular punch 3,5 mm 360° rotating, 15cm

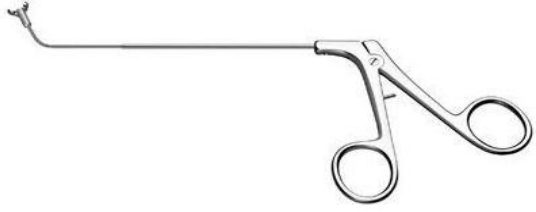

789586-70	Giraffe Forceps upward 70°, 130mm	 A pair of long-handled surgical forceps with a curved tip, designed for a 70-degree upward angle. The handles are curved for ergonomic use.
789586-90	Giraffe Forceps upward 110°, 130mm	 A pair of long-handled surgical forceps with a curved tip, designed for a 110-degree upward angle. The handles are curved for ergonomic use.
88-3802-14	sterilising container alu 58x28x20 cm silver	 A rectangular, silver-colored aluminum sterilizing container with a lid. The lid features a circular ventilation pattern and a central logo. The front of the container has a handle and a latch mechanism. A watermark 'INSTRUMENTS' is visible on the lid.