

DENTAL
INSTRUMENTE

DENTAL
INSTRUMENTS

INSTRUMENTS
DENTAIRE

INSTRUMENTOS DE
ODONTOLOGÍA

STRUMENTI
DENTALI

Distributed in New Zealand by:



Cooper Medical Limited
57 Mahunga Drive
Mangere Bridge
Auckland 2022



EDITION 06/16

ZEPF[®]
α
INSTRUMENTS
TUTTLINGEN
GERMANY

ZAHNZANGEN

EXTRACTING FORCEPS

DAVIERS

FÓRCEPS DE EXTRACCIÓN

TENAGLIE

Englische Form
English Pattern
Forme anglaise
Forma inglesa
Forma inglesa

ZAHNZANGEN

EXTRACTING FORCEPS

DAVIERS

FÓRCEPS DE EXTRACCIÓN

TENAGLIE

Nr. -09 = mit Haftprofil
No. -09 = With Non-Slip Square Profile
No. -09 = A mors quadrillés
Núm. -09 = Bocas con estrías cruzadas
No. 09 = Morso con zigrinatua quadra

* Gehört zum Standard-Satz
Part of basic set
Partie du jeu de base
Parte del juego de base
Parte del set basico

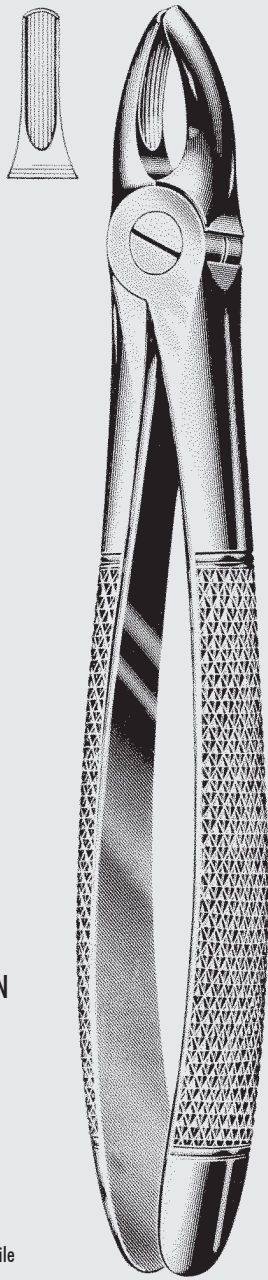

80-0001-00*

80-0001-09

Fig. 1

Für obere mittlere Schneide- und Eckzähne
For upper centrals and canines
Pour incisives centrales et canines supérieures
Para incisivos centrales y caninos superiores
Per incisivi centrali e canini superiori

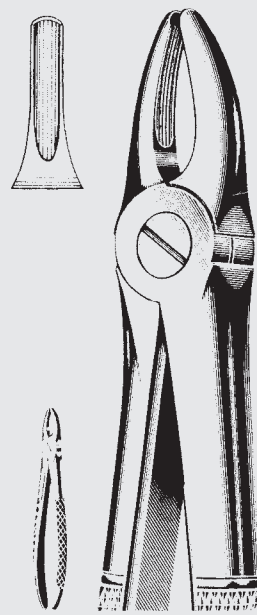

80-0002-00*

80-0002-09

Fig. 2

Für obere seitliche Schneidezähne und Prämolaren
For upper laterals and bicusps
Pour incisives latérales et prémolaires supérieures
Para incisivos laterales y premolares superiores
Per incisivi laterali e premolari superiori

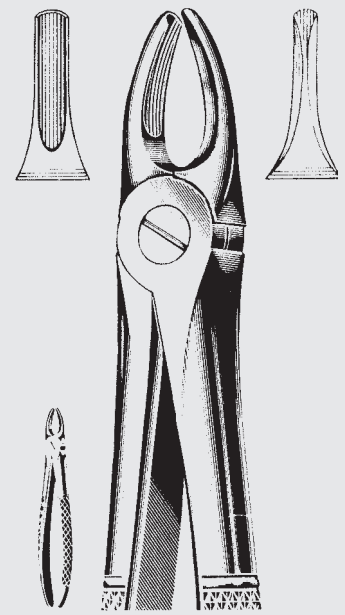

80-0003-00

Fig. 3

Für obere gedrängt stehende Schneide- und Eckzähne
For upper incisors and canines crowded internally or externally
Pour incisives et canines supérieures, surdents intérieures ou extérieures
Para incisivos y caninos superiores, supernumerarios internos o externos
Per incisivi e canini superiori, soprannumerari interni e esterni

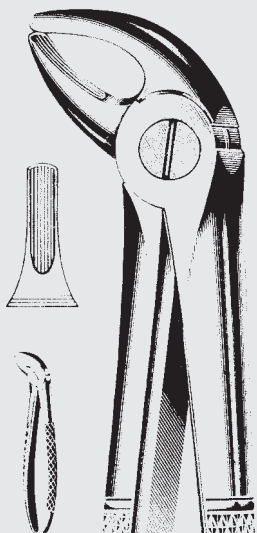

80-0004-00*

80-0004-09

Fig. 4

Für untere Schneide- und Eckzähne
For lower incisors and canines
Pour incisives et canines inférieures
Para incisivos y caninos inferiores
Per incisivi e canini inferiori

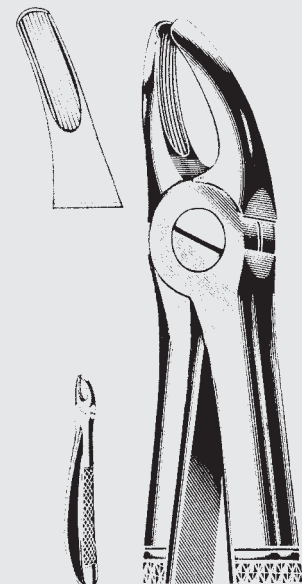

80-0007-00*

80-0007-09

Fig. 7

Für obere Prämolaren, beide Seiten
For upper bicusps, either side
Pour prémolaires supérieures des deux côtés
Para premolares superiores, ambos lados
Per premolari superiori, ambedue i lati

ZEPF[®]
α
INSTRUMENTS

80-0001-00

80.2

Englische Form
English Pattern
Forme anglaise
Forma inglesa
Forma inglesa

ZAHNZANGEN

EXTRACTING FORCEPS

DAVIERS

FÓRCEPS DE EXTRACCIÓN

TENAGLIE

Nr. -09 = mit Haftprofil
No. -09 = With Non-Slip Square Profile
No. -09 = A mors quadrillés
Núm. -09 = Bocas con estrías cruzadas
No. 09 = Morso con zigrinatua quadra

* Gehört zum Standard-Satz
Part of basic set
Partie du jeu de base
Parte del juego de base
Parte del set basico



80-0109-00

80.3

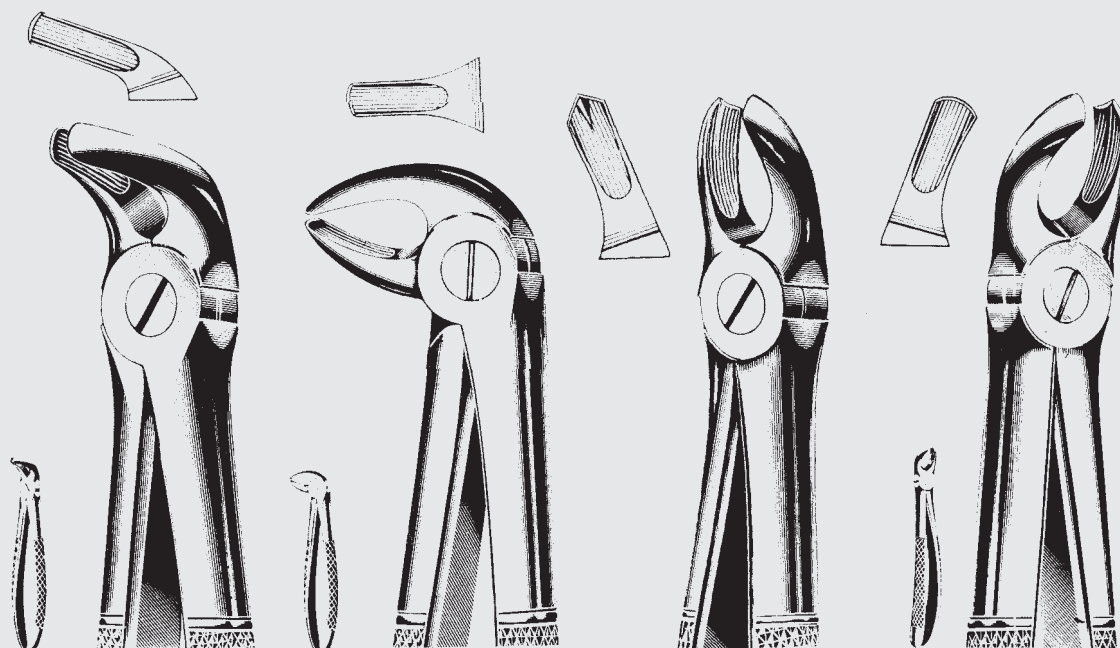

80-0008-00

Fig. 8

Für untere Prämolaren, beide Seiten
For lower bicuspsids, either side
Pour prémolaires inférieures des deux côtés
Para premolares inferiores, ambos lados
Per premolari inferiori, ambedue i lati

80-0103-00*

80-0103-09

Fig. 13

80-0107-00*

80-0107-09

Fig. 17

Für obere Molaren, rechts
For right upper molars
Pour molaires supérieures, côté droit
Para molares superiores, lado derecho
Per molari superiori destri

80-0108-00*

80-0108-09

Fig. 18

Für obere Molaren, links
For left upper molars
Pour molaires supérieures, côté gauche
Para molares superiores, lado izquierdo
Per molari superiori sinistri

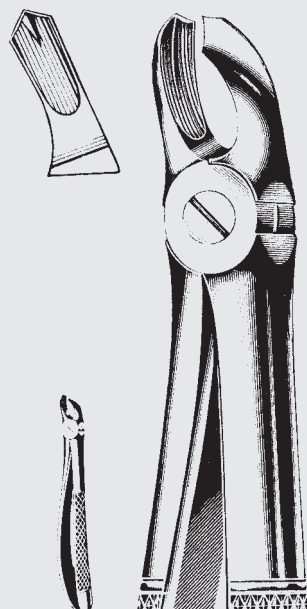

80-0108-01

Fig. 18A

Für obere Molaren, beide Seiten
For upper molars, either side
Pour molaires supérieures des deux côtés
Para molares superiores, ambos lados
Per molari superiori, ambedue i lati

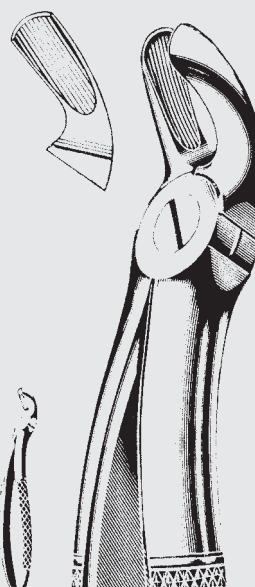

80-0109-00

Fig. 19

Für obere Weisheitszähne, beide Seiten
For upper wisdoms, either side
Pour dents de sagesse supérieures des deux côtés
Para cordales superiores, ambos lados
Per denti del giudizio superiori, ambedue i lati

Englische Form
English Pattern
Forme anglaise
Forma inglesa
Forma inglesa

ZAHNZANGEN

EXTRACTING FORCEPS

DAVIERS

FÓRCEPS DE EXTRACCIÓN

TENAGLIE

Nr. -09 = mit Haftprofil
No. -09 = With Non-Slip Square Profile
No. -09 = A mors quadrillés
Núm. -09 = Bocas con estrías cruzadas
No. 09 = Morso con zigrinatua quadra

* Gehört zum Standard-Satz
Part of basic set
Partie du jeu de base
Parte del juego de base
Parte del set básico

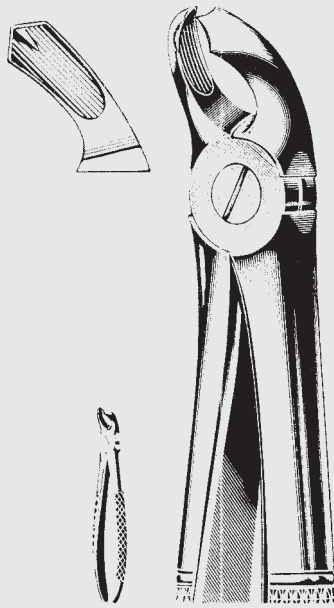

80-0200-00

Fig. 20

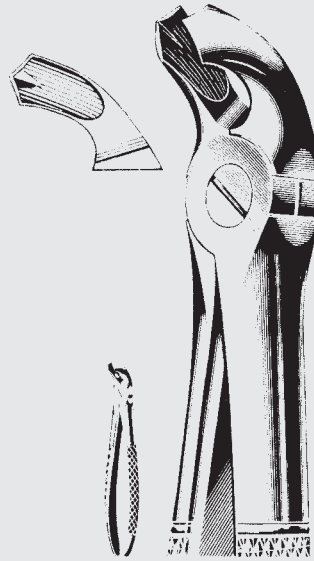

80-0201-00

Fig. 21

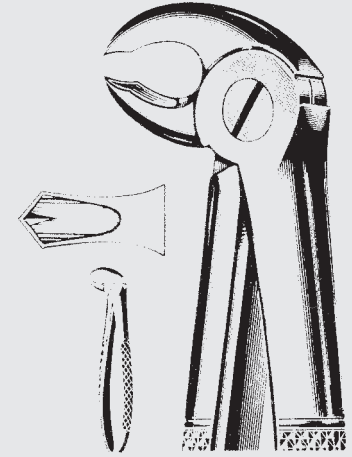

80-0202-00*

80-0202-09

Fig. 22

Für untere Weisheitszähne, beide Seiten
For lower wisdoms, either side
Pour dents de sagesse inférieures, des deux côtés
Para cordales inferiores, ambos lados
Per denti del giudizio, ambedue i lati

Für untere Molaren, beide Seiten
For lower molars, either side
Pour molaires inférieures des deux côtés
Para molares inferiores, ambos lados
Per molari inferiori, ambedue i lati

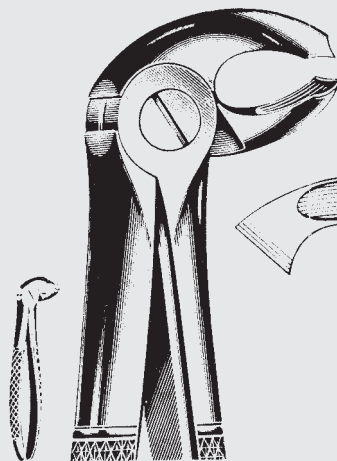

80-0203-00

Fig. 23

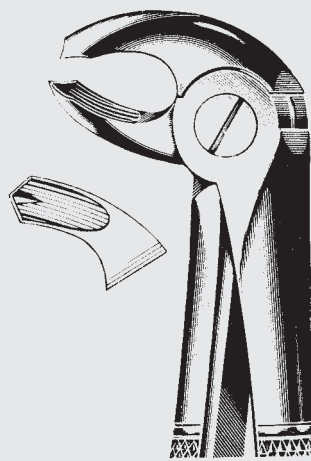

80-0204-00

Fig. 24

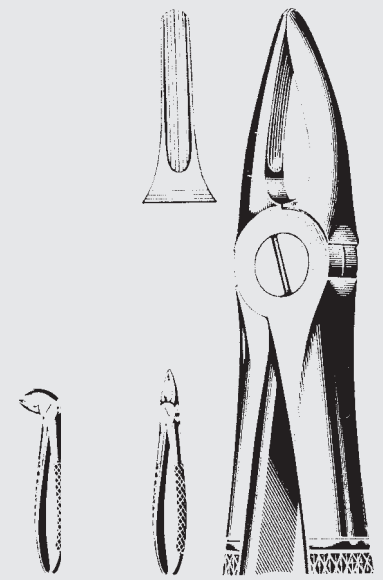

80-0209-00

Fig. 29

Für untere Molaren, rechts
For right lower molars
Pour molaires inférieures, côté droit
Para molares inferiores, lado derecho
Per molari inferiori destri

Für untere Molaren, links
For left lower molars
Pour molaires inférieures, côté gauche
Para molares inferiores, lado izquierdo
Per molari inferiori sinistri

Für obere Wurzeln und Schneidezähne, beide Seiten
For upper roots and incisors, either side
Pour racines et incisives supérieures des deux côtés
Para raíces e incisivos superiores, ambos lados
Per radici e incisivi superiori, ambedue i lati

Englische Form
English Pattern
Forme anglaise
Forma inglesa
Forma inglesa

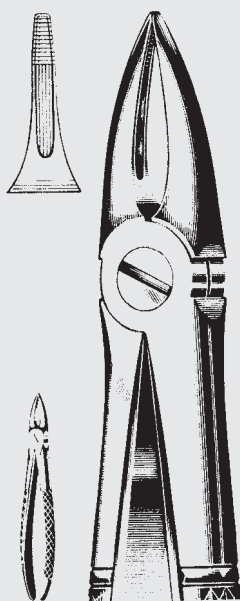

80-0209-07
Fig. 29N

Für obere Schneidezahnwurzeln
For roots of upper incisors
Pour racines d'incisives supérieures
Para raíces de incisivos superiores
Per radici di incisivi superiori

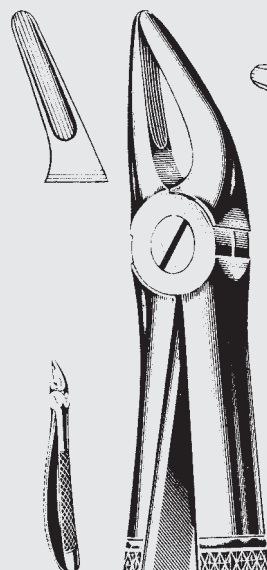

80-0300-00
Fig. 30

Für obere Wurzeln und Schneidezähne, beide Seiten
For upper roots and incisors, either side
Pour racines et incisives supérieures, des deux côtés
Para raíces e incisivos superiores, ambos lados
Per radici e incisivi superiori, ambedue i lati

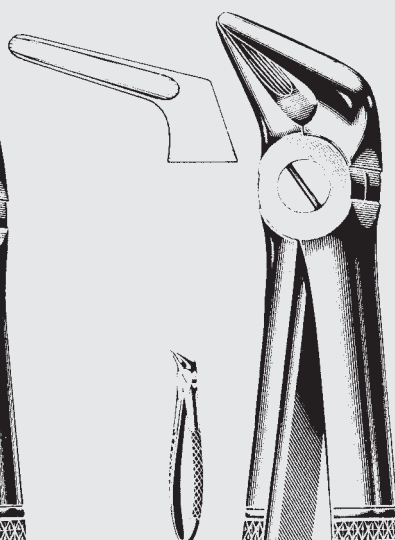

80-0301-00
Fig. 31

Für untere Wurzeln, beide Seiten
For lower roots, either side
Pour racines inférieures, des deux côtés
Para raíces inferiores, ambos lados
Per radici inferiori, ambedue i lati

ZAHNZANGEN

EXTRACTING FORCEPS

DAVIERS

FÓRCEPS DE EXTRACCIÓN

TENAGLIE

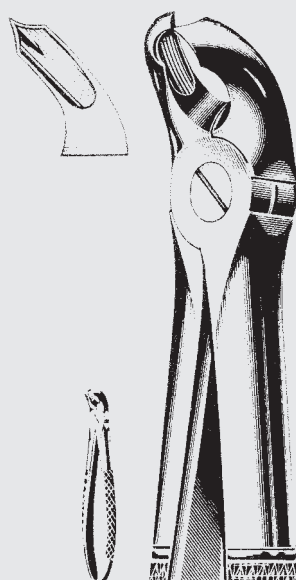

80-0302-00
Fig. 32

Für untere Molaren mit kariösen Kronen, beide Seiten
For lower molars, with decayed or broken-down crowns, either side
Pour molaires inférieures cariées ou découronnées, des deux côtés
Para molares inferiores cariados o con las coronas dañadas, ambos lados
Per molari inferiori cariati o scoronati, ambedue i lati

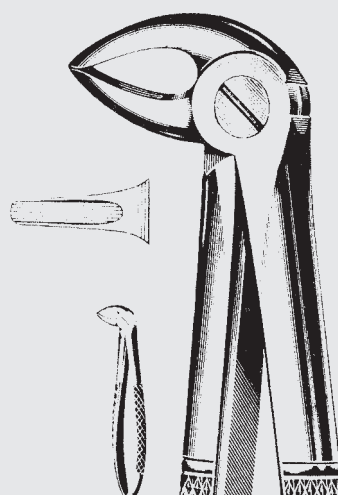

80-0303-00*
80-0303-09
Fig. 33

Für untere Wurzeln, beide Seiten
For lower roots, either side
Pour racines inférieures des deux côtés
Para raíces inferiores, ambos lados
Per radici inferiori, ambedue i lati

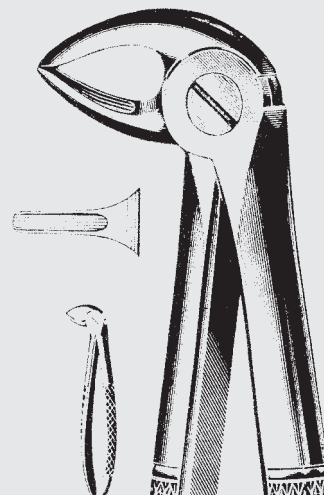

80-0303-01*
80-0303-95
Fig. 33A

Schlankes Maul, für untere Wurzeln, beide Seiten
For lower roots, either side, slender pattern
Pour racines inférieures des deux côtés, à bec étroits
Para raíces inferiores, ambos lados, con pico angosto
Per radici inferiori, ambedue i lati, morso fino

Nr. -09 = mit Haftprofil
No. -09 = With Non-Slip Square Profile
No. -09 = A mors quadrillés
Núm. -09 = Bocas con estrías cruzadas
No. 09 = Morso con zigrinatua quadra

* Gehört zum Standard-Satz
Part of basic set
Partie du jeu de base
Parte del juego de base
Parte del set básico



80-0303-95

80.5

Englische Form
English Pattern
Forme anglaise
Forma inglesa
Forma inglesa

ZAHNZANGEN

EXTRACTING FORCEPS

DAVIERS

FÓRCEPS DE EXTRACCIÓN

TENAGLIE

Nr. -09 = mit Haftprofil
No. -09 = With Non-Slip Square Profile
No. -09 = A mors quadrillés
Núm. -09 = Bocas con estrías cruzadas
No. 09 = Morso con zigrinatua quadra

* Gehört zum Standard-Satz
Part of basic set
Partie du jeu de base
Parte del juego de base
Parte del set basico

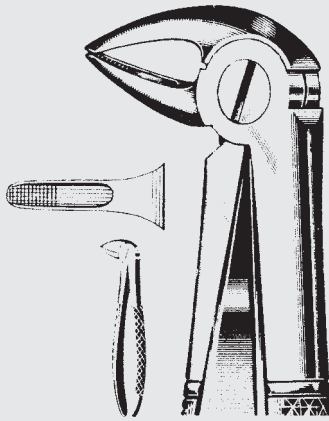

80-0303-03
Fig. 33C

Schlankes Maul, für untere Wurzeln, beide Seiten
For lower roots, either side, slender pattern
Pour racines inférieures des deux côtés, à bec étroits
Para raíces inferiores, ambos lados, con pico angosto
Per radici inferiori, ambedue i lati, morso fino

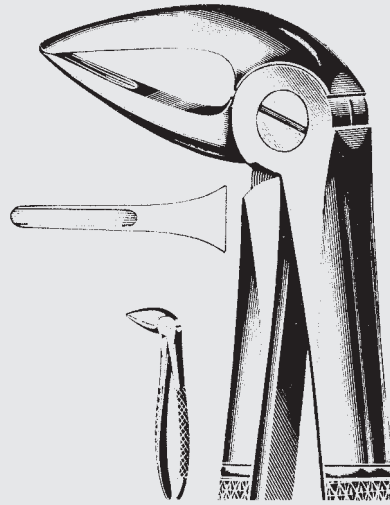

80-0303-06
Fig. 33M

Langes Maul, für tief sitzende untere Wurzeln
With long beak for very deep lower roots, either side
Pour racines inférieures très profondes, à bec très longs, des deux côtés
Para raíces inferiores muy profundas, ambos lados, con pico largo
Per radici inferiori molto profonde, ambedue i lati, con morso lungo

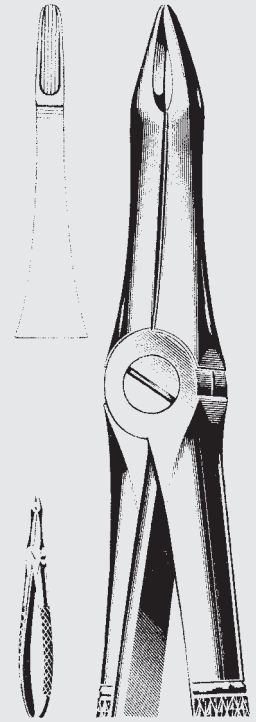

80-0401-00
Fig. 41

Für obere Wurzeln, beide Seiten
For upper roots, either side
Pour racines supérieures des deux côtés
Para raíces superiores, ambos lados
Per radici superiori, ambedue i lati

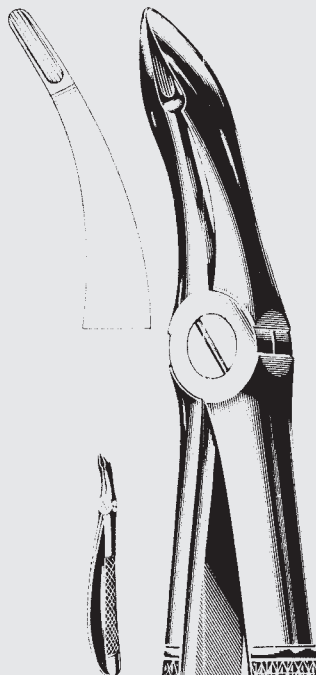

80-0404-00
Fig. 44

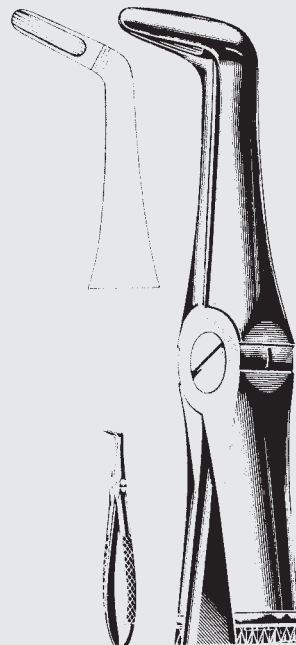

80-0405-00
Fig. 45

Für obere Wurzeln, beide Seiten
For upper roots, either side
Pour racines supérieures, des deux côtés
Para raíces superiores, ambos lados
Per radici superiori, ambedue i lati

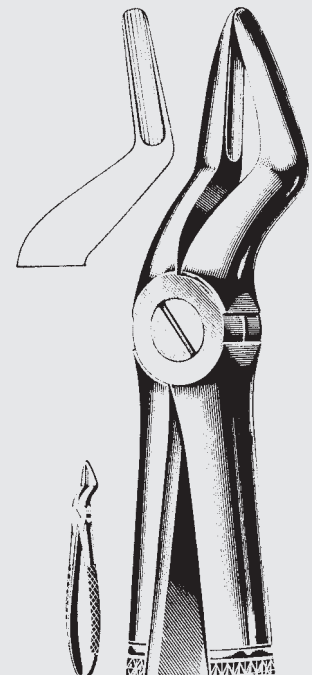

80-0501-00*
80-0501-09
Fig. 51

Für obere Wurzeln
For upper roots
Pour racines supérieures
Para raíces superiores
Per radici superiori

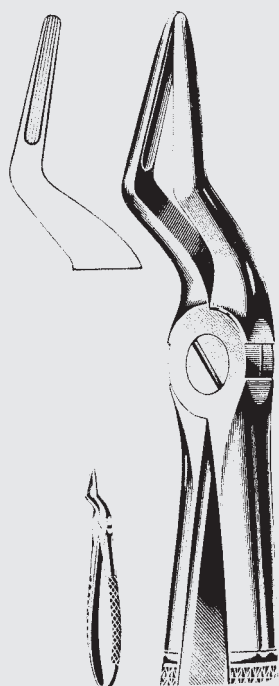

80-0501-01*
80-0501-95
Fig. 51A

Für obere Wurzeln, mit extra schmalem Schnabel
For upper roots, with extra narrow beak
Pour racines supérieures, à mors extrêmement étroits
Para raíces superiores, con pico muy angosto
Per radici superiori, con morso molto stretto

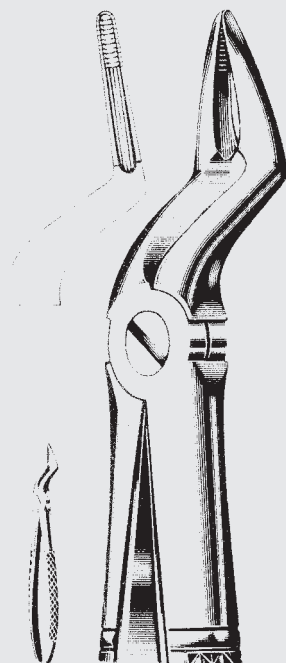

80-0501-03
Fig. 51C

Für obere Wurzeln
For upper roots
Pour racines supérieures
Para raíces superiores
Per radici superiori

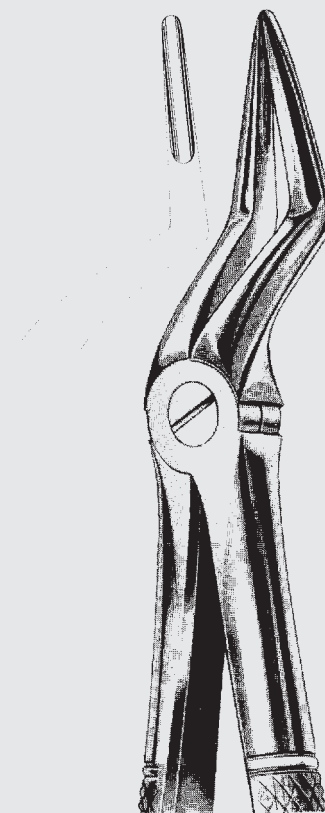

80-0501-05
Fig. 51L

Für obere Wurzeln, mit extra langem Schnabel für tief sitzende Wurzeln
For upper roots, with very long beak for deep upper roots
Pour racines supérieures très profondes, avec les bcs très longs
Para raíces superiores muy profundas, con pico muy largo
Per radici superiori molto profonde, con morso molto lungo

ZAHNZANGEN

Englische Form
English Pattern
Forme anglaise
Forma inglesa
Forma inglesa

EXTRACTING FORCEPS

DAVIERS

FÓRCEPS DE EXTRACCIÓN

TENAGLIE

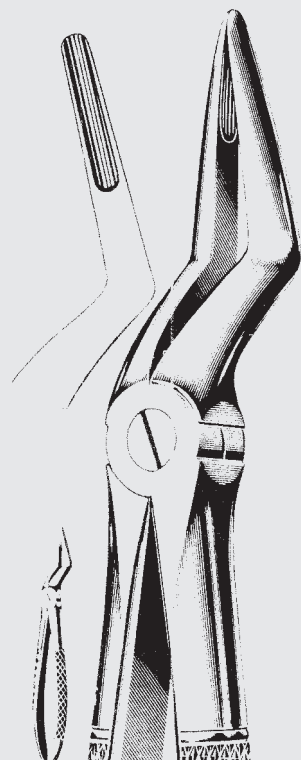

80-0501-06
Fig. 51M

Für obere Wurzeln, mit extra langem Schnabel für tief sitzende Wurzeln
For upper roots, with very long beak for deep upper roots
Pour racines supérieures très profondes, avec les bcs très longs
Para raíces superiores muy profundas, con pico muy largo
Per radici superiori molto profonde, con morso molto lungo

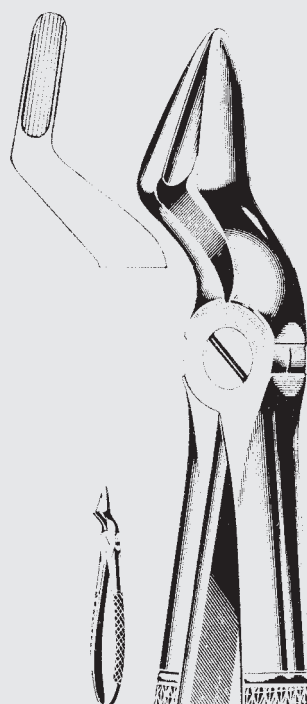

80-0502-00*
Fig. 52

Für obere Wurzeln und Eckzähne, mit breitem Schnabel
For upper roots and canines, with wide beak
Pour racines et canines supérieures, avec les bcs larges
Para raíces y caninos superiores, con pico ancho
Per radici e canini superiori, con morso largo

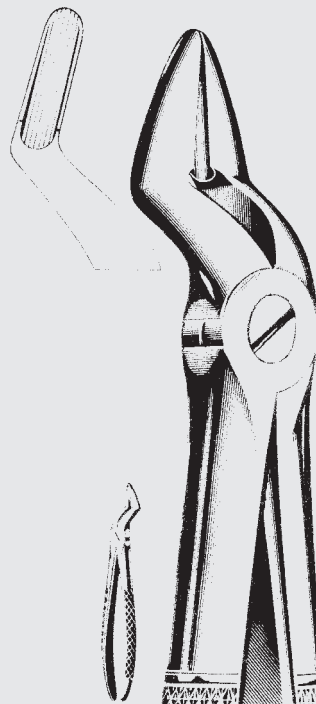

80-0502-01*
Fig. 52A

Für obere Zähne und Resektion, beide Seiten
For upper roots and resection, either side
Pour dents supérieures et la résection, des deux côtés
Para dientes superiores y resección, ambos lados
Per denti superiori e resezione, ambedue i lati

Nr. -09 = mit Haftprofil
No. -09 = With Non-Slip Square Profile
No. -09 = A mors quadrillés
Núm. -09 = Bocas con estrías cruzadas
No. 09 = Morso con zigrinatua quadra

* Gehört zum Standard-Satz
Part of basic set
Partie du jeu de base
Parte del juego de base
Parte del set básico



80-0502-01

80.7

Englische Form
English Pattern
Forme anglaise
Forma inglesa
Forma inglesa

ZAHNZANGEN

EXTRACTING FORCEPS

DAVIERS

FÓRCEPS DE EXTRACCIÓN

TENAGLIE

Nr. -09 = mit Haftprofil
No. -09 = With Non-Slip Square Profile
No. -09 = A mors quadrillés
Núm. -09 = Bocas con estrías cruzadas
No. 09 = Morso con zigrinatua quadra

* Gehört zum Standard-Satz
Part of basic set
Partie du jeu de base
Parte del juego de base
Parte del set basico

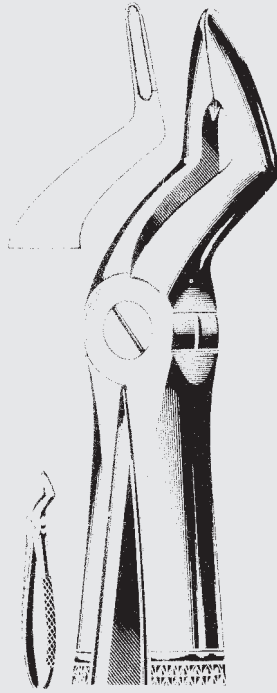

WITZEL
80-0503-00*

Für obere Wurzeln
For upper roots
Pour racines supérieures
Para raíces superiores
Per radici superiori

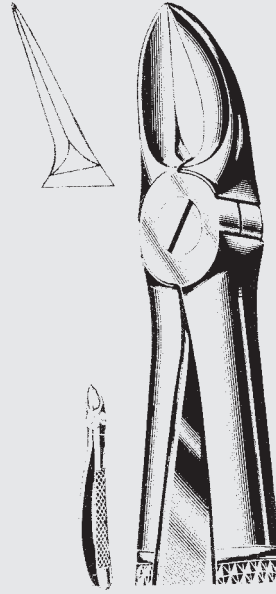

80-0505-00
Fig. 55

Spaltzange für obere Molarenwurzeln
For separating upper molar roots
Pour séparer les racines des molaires supérieures
Para separar raíces de molares superiores
Per separare radici di molari superiori



80-0506-00
Fig. 56

Spaltzange für untere Molarenwurzeln
For separating lower molar roots
Pour séparer les racines des molaires inférieures
Para separar raíces de molares inferiores
Per separare radici di molari inferiori

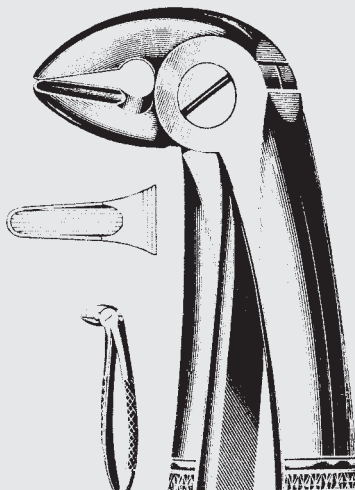

BUSCH
80-0509-00

Resektionszange für untere Wurzeln, breiter Schnabel
Resection forceps for lower roots, wide beak
Davier à résection pour racines inférieures, bec larges
Fórceps para resección para raíces inferiores, con pico ancho
Tenaglia per la resezione per radici inferiori, con morso largo

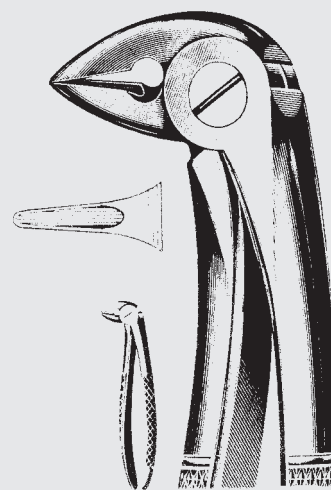

BUSCH
80-0600-00

- schmaler Schnabel
- narrow beak
- bec étroits
- pico estrecho
- morso stretto

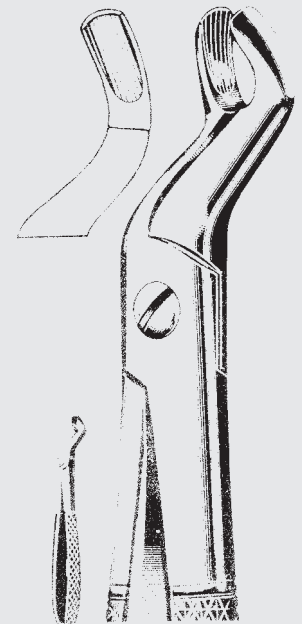

80-0607-00*
80-0607-09
Fig. 67

Für obere Weisheitszähne, beide Seiten
For upper wisdoms, either side
Pour dents de sagesse supérieures, des deux côtés
Para cordales superiores, ambos lados
Per denti del giudizio superiori, ambedue i lati

Englische Form
English Pattern
Forme anglaise
Forma inglesa
Forma inglesa

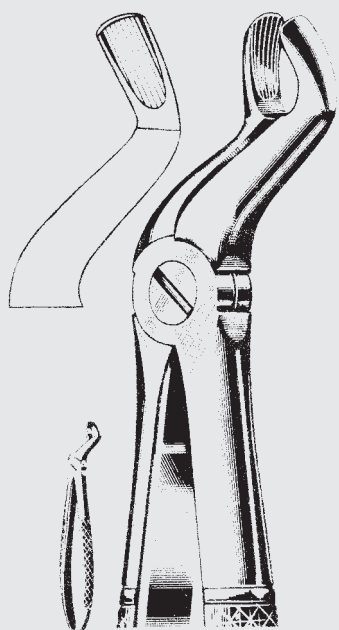

80-0607-01*
80-0607-19
Fig. 67A

Für obere Weisheitszähne, beide Seiten
For upper wisdoms, either side
Pour dents de sagesse supérieures, des deux côtés
Para cordales superiores, ambos lados
Per denti del giudizio, ambedue i lati

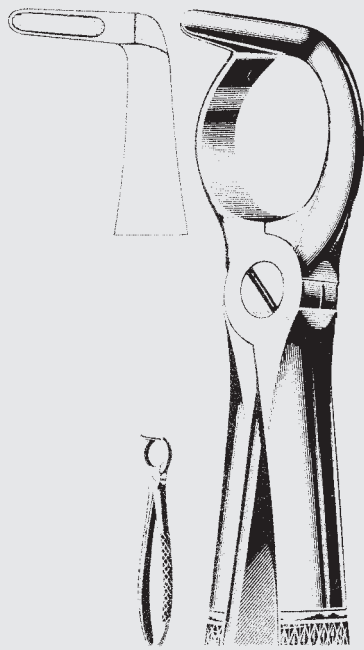

RYDING
80-0608-00

Für untere Wurzeln, beide Seiten
For lower roots, either side
Pour racines inférieures, des deux côtés
Para raíces inferiores, ambos lados
Per radici inferiori, ambedue i lati

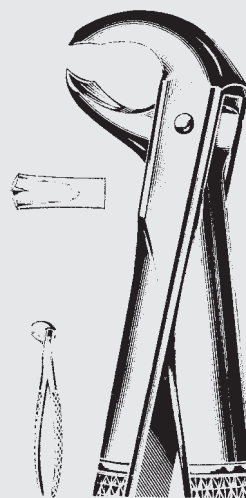

80-0703-00
Fig. 73

Für untere Molaren, beide Seiten
For lower molars, either side
Pour molaires inférieures, des deux côtés
Para molares inferiores, ambos lados
Per molari inferiori, ambedue i lati

ZAHNZANGEN

EXTRACTING FORCEPS

DAVIERS

FÓRCEPS DE EXTRACCIÓN

TENAGLIE

Nr. -09 = mit Haftprofil
No. -09 = With Non-Slip Square Profile
No. -09 = A mors quadrillés
Núm. -09 = Bocas con estrías cruzadas
No. 09 = Morso con zigrinatua quadra

* Gehört zum Standard-Satz
Part of basic set
Partie du jeu de base
Parte del juego de base
Parte del set basico

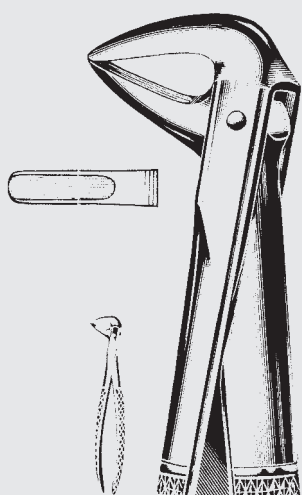

80-0704-00*
80-0704-09
Fig. 74

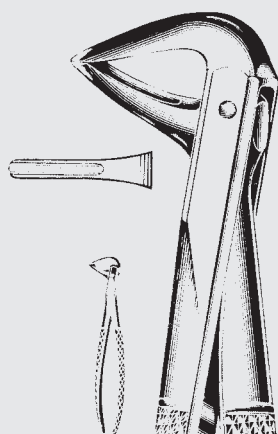

80-0704-06
Fig. 74M

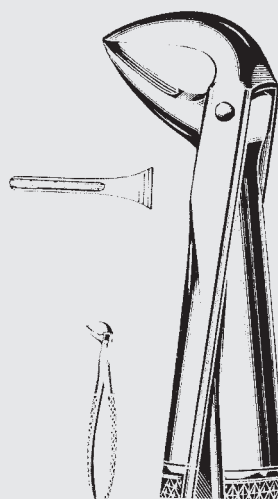

80-0704-07
Fig. 74N

Für untere Schneidezähne und Wurzeln, beide Seiten
For lower incisors and roots, either side
Pour incisives et racines inférieures, des deux côtés
Para incisivos y raíces inferiores, ambos lados
Per incisivi e radici inferiori, ambedue i lati



80-0704-07

80.9

Englische Form
English Pattern
Forme anglaise
Forma inglesa
Forma inglesa

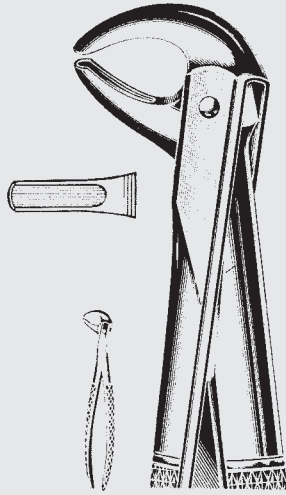

80-0705-00

Fig. 75

Für untere Eckzähne und Prämolaren, beide Seiten
For lower bicuspid and canines, either side
Pour canines et prémolaires inférieures des deux côtés
Para caninos y premolares inferiores, ambos lados
Per canini e premolari inferiori, ambedue i lati

LAWRENCE READ
80-0706-00

Fig. 76

Für obere Wurzeln, beide Seiten
For upper roots, either side
Pour racines supérieures, des deux côtés
Para raíces superiores, ambos lados
Per radici superiori, ambedue i lati

LAWRENCE READ
80-0706-07

Fig. 76N

Für obere Wurzeln, beide Seiten, mit schmalen Schnabel
For upper roots, either side, with narrow beak
Pour racines supérieures des deux côtés, becs étroits
Para raíces superiores, ambos lados, con pico estrecho
Per radici superiori, ambedue i lati, con morso stretto

ZAHNZANGEN

EXTRACTING FORCEPS

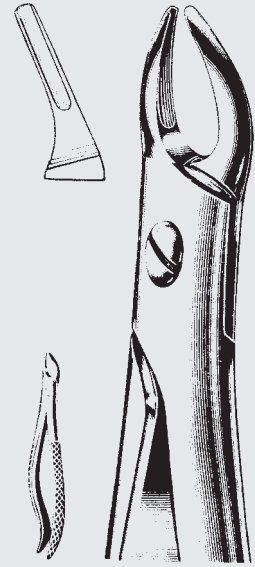
DAVIERS

FÓRCEPS DE EXTRACCIÓN

TENAGLIE

Nr. -09 = mit Haftprofil
No. -09 = With Non-Slip Square Profile
No. -09 = A mors quadrillés
Núm. -09 = Bocas con estrías cruzadas
No. 09 = Morso con zigrinatua quadra

* Gehört zum Standard-Satz
Part of basic set
Partie du jeu de base
Parte del juego de base
Parte del set basico

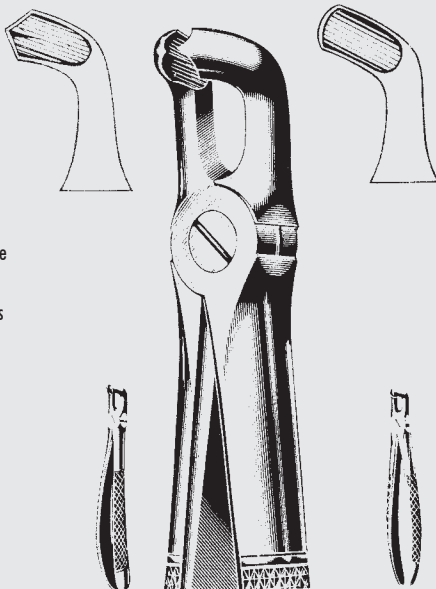

80-0709-00*

80-0709-09

Fig. 79

80-0709-01*

80-0709-19

Fig. 79A

Für untere Weisheitszähne, beide Seiten
For lower wisdoms, either side
Pour dents de sagesse inférieures, des deux côtés
Para cordales inferiores, ambos lados
Per denti del giudizio, ambedue i lati

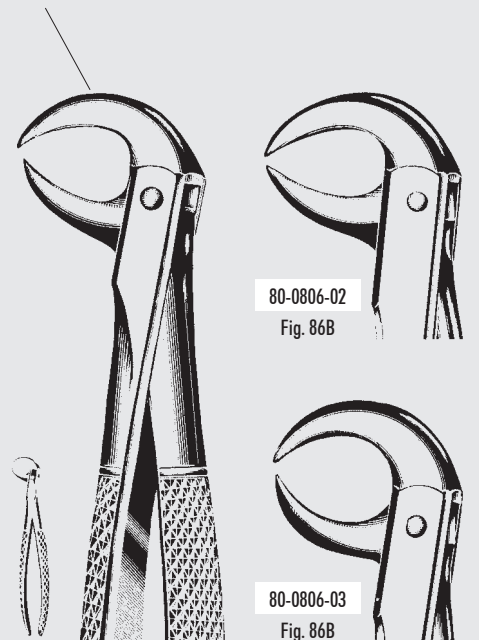

80-0806-02

Fig. 86B

80-0806-03

Fig. 86B

80-0806-01

Fig. 86A

ZEPF[®]
&
INSTRUMENTS

80-0705-00

80.10

Für obere Molaren, rechts
 For right upper molars
 Pour molaires supérieures, côté droit
 Para molares superiores, lado derecho
 Per molari superiori destri

Für obere Molaren, links
 For left upper molars
 Pour molaires supérieures, côté gauche
 Para molares superiores, lado izquierdo
 Per molari superiori sinistri

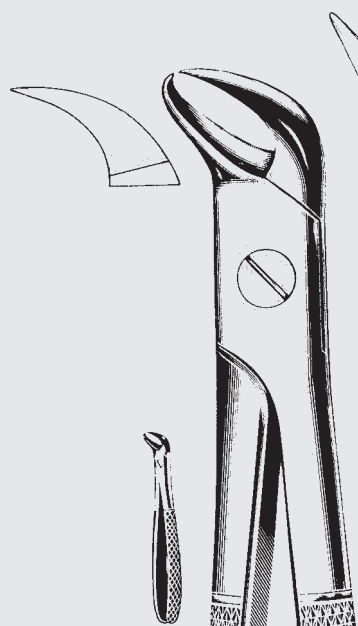

80-0807-00
 Fig. 87

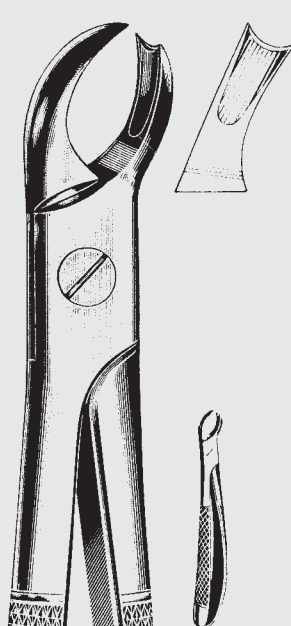

80-0809-00
 Fig. 89

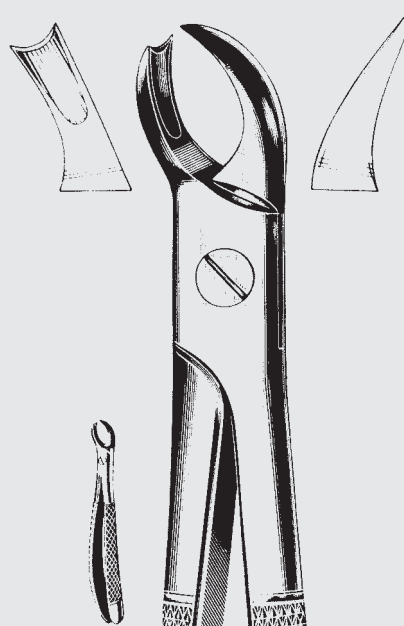

80-0900-00
 Fig. 90

Für untere Molaren, mit kariösen oder abgebrochenen Kronen, beide Seiten (Kuhhornschnabel)
 For lower molars with decayed or broken-down crowns, either side (cow horn beak)
 Pour molaires inférieures, cariées ou découronnées, des deux côtés (forme de corne de vache)
 Para molares inferiores muy cariosos o con las coronas dañadas, ambos lados (forma cuerno de vaca)
 Per molari inferiori molto carciati oppure con le corone dannegiate, ambedue i lati (forma corno di vacca)

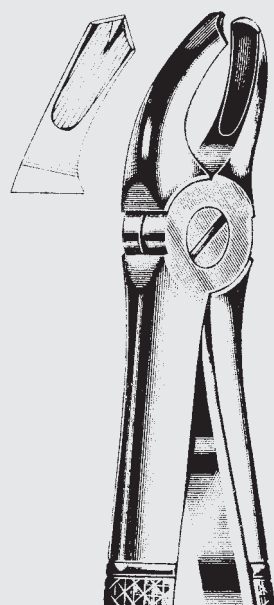

80-0904-00
 Fig. 94

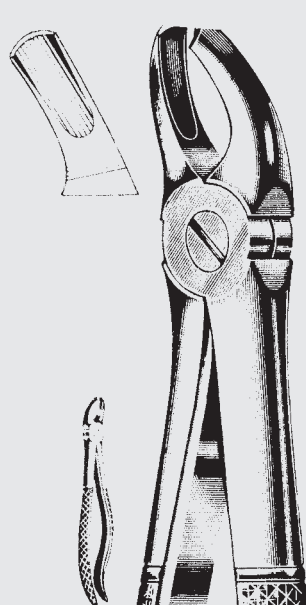

80-0905-00
 Fig. 95

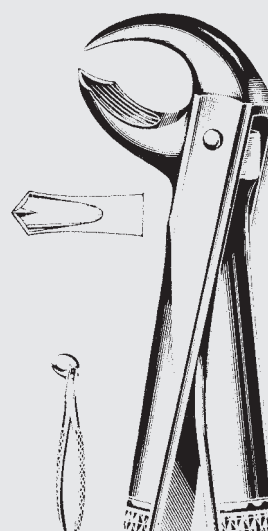

WOOD (PASSOW)
 80-0909-00
 Fig. 99

Für obere Molaren, rechts
 For right upper molars
 Pour molaires supérieures, côté droit
 Para molares superiores, lado derecho
 Per molari superiori destri

Für obere Molaren, links
 For left upper molars
 Pour molaires supérieures, côté gauche
 Para molares superiores, lado izquierdo
 Per molari superiori, sinistri

Für untere abgebrochene Molaren, beide Seiten
 For broken-down lower molars, either side
 Pour molaires inférieures découronnées, des deux côtés
 Para molares inferiores con las coronas dañadas, ambos lados
 Per molari inferiori colle corone daneggiate, ambedue i lati

Englische Form
 English Pattern
 Forme anglaise
 Forma inglesa
 Forma inglesa

ZAHNZANGEN

EXTRACTING FORCEPS

DAVIERS

FÓRCEPS DE EXTRACCIÓN

TENAGLIE

Nr. -09 = mit Haftprofil
 No. -09 = With Non-Slip Square Profile
 No. -09 = A mors quadrillés
 Núm. -09 = Bocas con estrías cruzadas
 No. 09 = Morso con zigrinatua quadra

* Gehört zum Standard-Satz
 Part of basic set
 Partie du jeu de base
 Parte del juego de base
 Parte del set basico



80-0909-00

80.11

Englische Form
English Pattern
Forme anglaise
Forma inglesa
Forma inglesa

ZAHNZANGEN

EXTRACTING FORCEPS

DAVIERS

FÓRCEPS DE EXTRACCIÓN

TENAGLIE

Für obere Schneidezähne und Wurzeln
For upper incisors and roots
Pour incisives et racines supérieures
Para incisivos y raíces superiores
Per incisivi e radici superiori

Für untere Schneidezähne und Wurzeln
For lower incisors and roots
Pour incisives et racines inférieures
Para incisivos y raíces inferiores
Per incisivi e radici inferiori

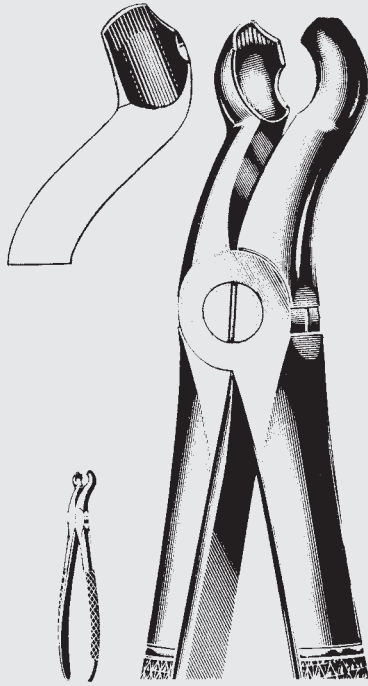

OGDEN-FELSCH

80-1201-00

Fig. 121

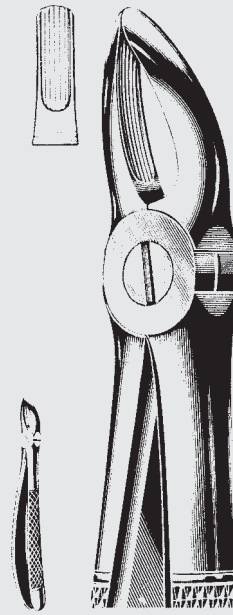

GUY

80-1306-00

Fig. 136

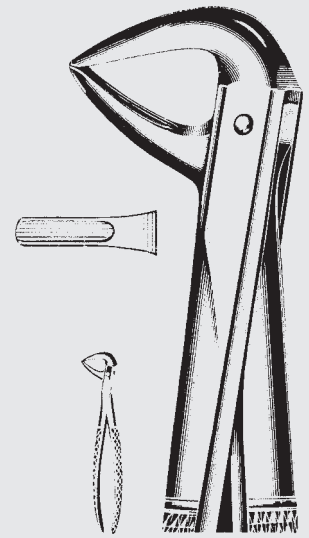

GUY

80-1307-00

Fig. 137

Für obere Weisheitszähne, mit Fangvorrichtung

For upper wisdoms, with special beak for retaining the tooth extracted

Pour dents de sagesse supérieures, avec becs spéciaux pour retenir la dent extraite

Para cordales superiores, con pico especial para retener los dientes extraídos

Per denti del giudizio superiori, con morso speciale per la ritenzione dei denti estratti

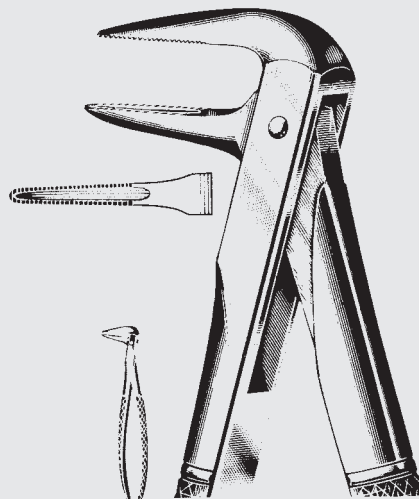

80-2303-00

Fig. 233

Für untere Wurzeln, mit Parallelmaul

For lower roots, with parallel beaks

Pour racines inférieures, avec les becs parallèles

Para raíces inferiores, con picos paralelos

Per radici inferiori, con morso parallelo

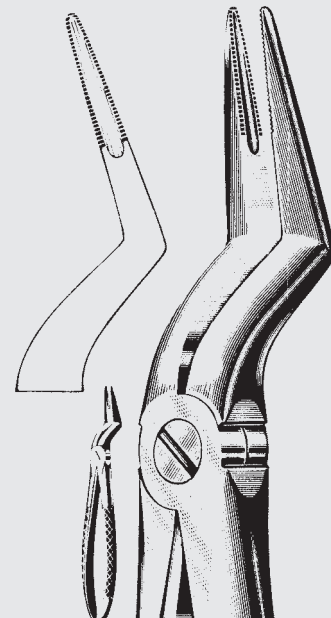

80-2305-00

Fig. 235

Für obere Wurzeln, mit Parallelmaul

For upper roots, with parallel beaks

Pour racines supérieures, avec les becs parallèles

Para raíces superiores, con picos paralelos

Per radici superiori, con morso parallelo

Englische Form
English Pattern
Forme anglaise
Forma inglesa
Forma inglesa

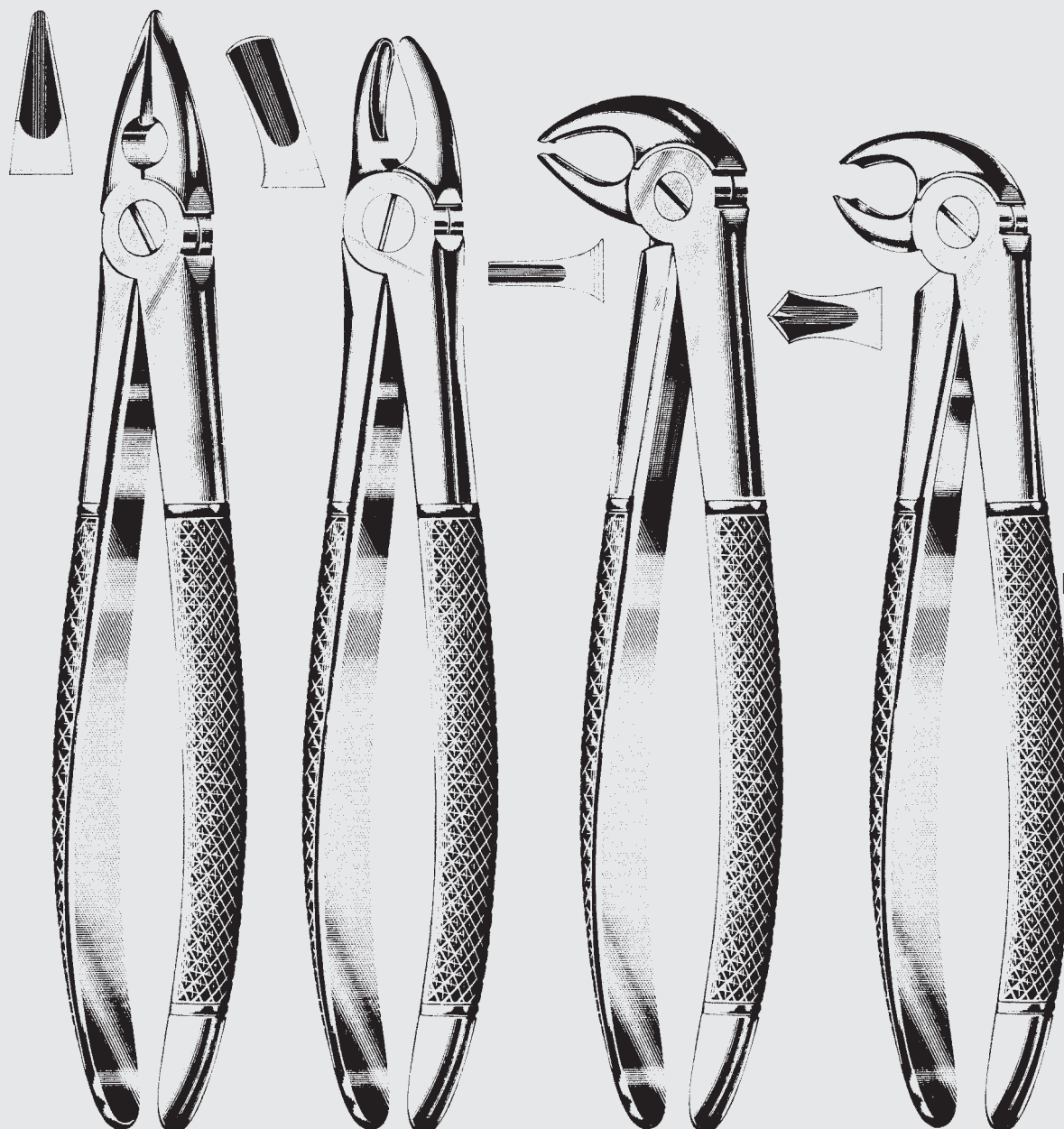

MEAD
80-3801-00
Fig. MD 1

Für obere Weisheitszähne, Prämolaren und Wurzeln
For upper wisdoms, bicuspid and upper roots
Pour dents de sagesse, prémolaires et racines supérieures
Para cordales, premolares y raíces superiores
Per denti del giudizio, premolari e radici superiori

MEAD
80-3802-00
Fig. MD 2

Für obere Molaren
For upper molars
Pour molaires supérieures
Para molares superiores
Per molari superiori

MEAD
80-3803-00
Fig. MD 3

Für untere Schneidezähne, Prämolaren und Wurzeln
For lower incisors, bicuspid and roots
Pour incisives, prémolaires et racines inférieures
Para incisivos, premolares y raíces inferiores
Per incisivi, premolari e radici inferiori

MEAD
80-3804-00
Fig. MD 4

Für untere Molaren
For lower molars
Pour molaires inférieures
Para molares inferiores
Per molari inferiori

ZAHNZANGEN

EXTRACTING FORCEPS

DAVIERS

FÓRCEPS DE EXTRACCIÓN

TENAGLIE

Universal-Zahnzangen
Universal Extracting Forceps
Daviers universels
Fórceps universales
Tenaglie universali

ZEPF[®]
INSTRUMENTS

80-3804-00

80.13

ZAHNZANGEN

EXTRACTING FORCEPS

DAVIERS

FÓRCEPS DE EXTRACCIÓN

TENAGLIE

Universal-Zahnzangen
 Universal Extracting Forceps
 Daviers universels
 Fórceps universales
 Tenaglie universali

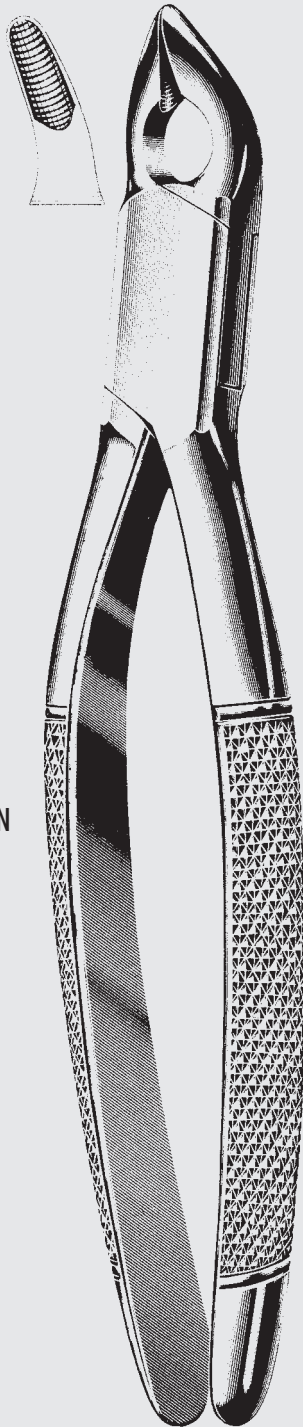

COHEN

80-4001-00

Amerikanisches Modell
 American pattern
 Forme américaine
 Forma americana
 Forma americana

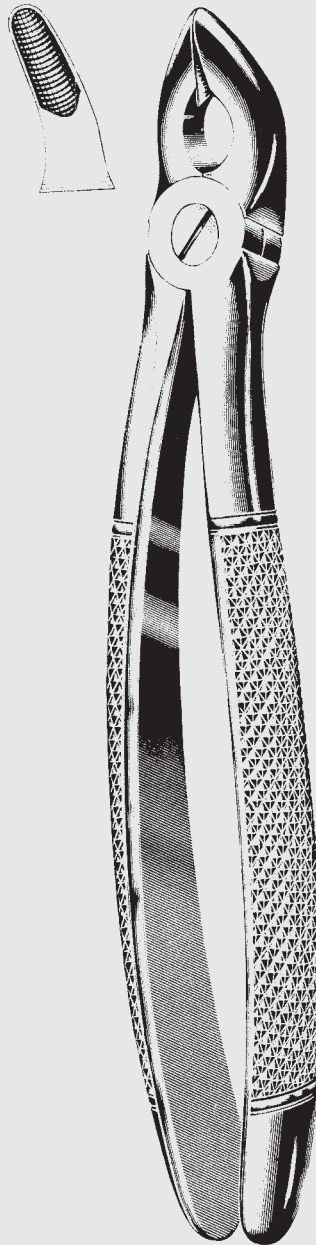

COHEN

80-4002-00

Englisches Modell
 English pattern
 Forme anglaise
 Forma inglesa
 Forma inglese

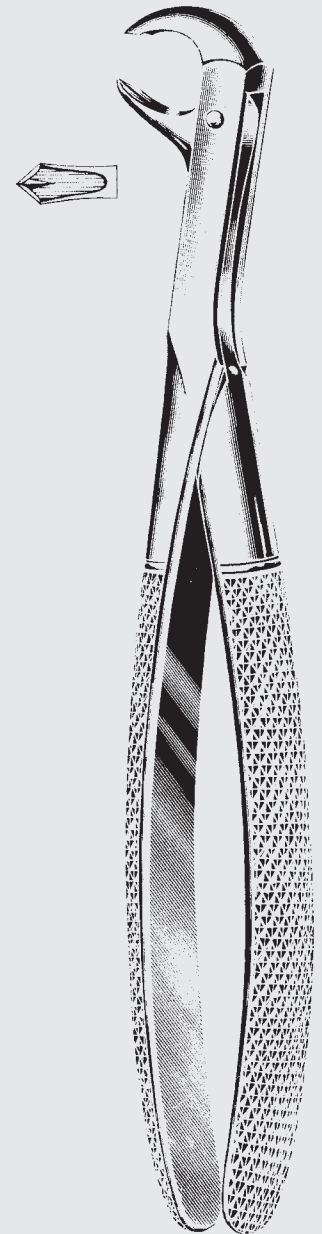

STIKSA

80-4101-00

Für untere Weisheitszähne und Molaren, beide Seiten
 For lower wisdoms and molars, either side
 Pour dents de sagesse et molaires inférieures, des deux côtés
 Para cordales y molares inferiores, ambos lados
 Per denti del giudizio e molari inferiori, ambedue i lati

ZEPF[®]
α
 INSTRUMENTS

80-4001-00

80.14

links - left side - côté gauche - lado izquierdo - sinistro rechts - right side - côté droit - lado derecho - destro

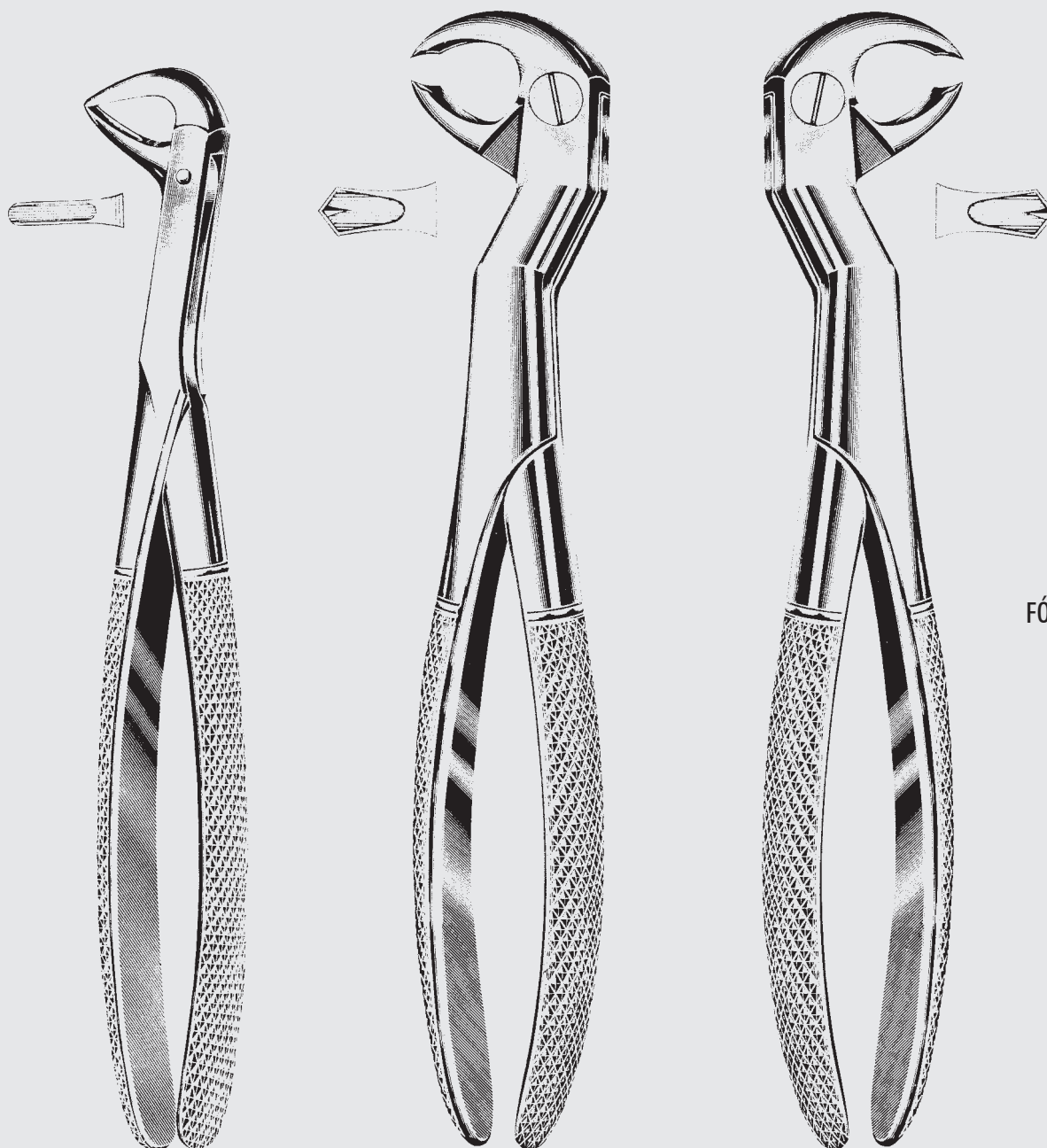

STIKSA
80-4102-00

ROUTURIER
80-4202-05

ROUTURIER
80-4202-08

Für Wurzeln von unteren Molaren und Weisheitszähnen, beide Seiten
 For roots of lower molars and wisdoms, either side
 Pour racines des dents de sagesse et molaires inférieures, des deux côtés
 Para raíces de molares y cordales inferiores, ambos lados
 Per radici di molari e denti del giudizio inferiori, ambedue i lati

Für untere Weisheitszähne und Molaren
 For lower wisdoms and molars
 Pour dents de sagesse et molaires inférieures
 Para cordales y molares inferiores
 Per denti del giudizio e molari inferiori

ZAHNZANGEN

EXTRACTING FORCEPS

DAVIERS

FÓRCEPS DE EXTRACCIÓN

TENAGLIE

ZEPF[®]
OX
 INSTRUMENTS

80-4202-08

80.15

Kinder-Zahnzangen, englische Form
 Extracting Forceps for Children, English Pattern
 Daviers pour enfants, modèle anglais
 Fórceps para niños, forma inglesa
 Tenaglia per bambini, forma inglese

ZAHNZANGEN

EXTRACTING FORCEPS

DAVIERS

FÓRCEPS DE EXTRACCIÓN

TENAGLIE

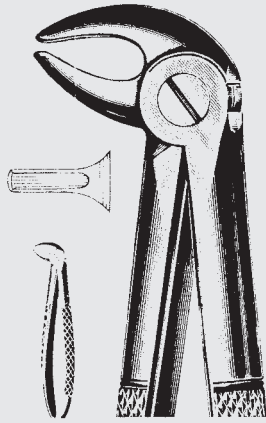

80-6103-09

Fig. 13S

Für untere Prämolaren, beide Seiten
 For lower bicuspid, either side
 Pour prémolaires inférieures, des deux côtés
 Para premolares inferiores, ambos lados
 Per premolari inferiori, ambedue i lati

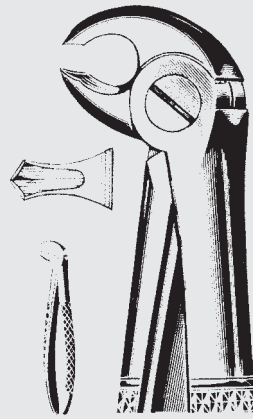

80-6202-09

Fig. 22S

Für untere Molaren, beide Seiten (Habichtsschnabel)
 For lower molars, either side (hawk's bill)
 Pour molaires inférieures des deux côtés
 Para molares inferiores, ambos lados (pico de azor)
 Per molari inferiori, ambedue i lati

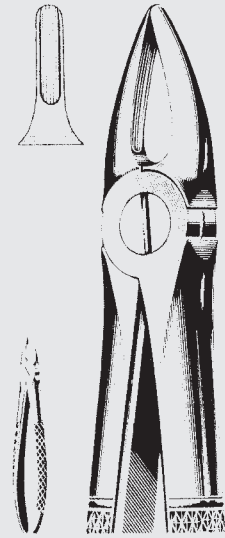

80-6209-09

Fig. 29S

Für obere Schneidezähne und Wurzeln, beide Seiten
 For upper incisors and roots, either side
 Pour incisives et racines supérieures, des deux côtés
 Para incisivos y raíces superiores, ambos lados
 Per incisivi e radici superiori, ambedue i lati

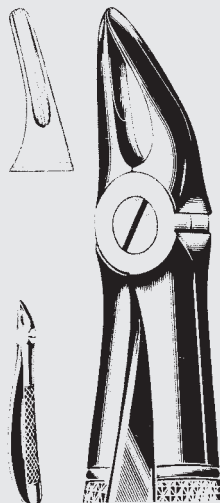

80-6300-09

Fig. 30S

Für obere Schneidezähne und Wurzeln, beide Seiten
 For upper roots, either side
 Pour racines supérieures, des deux côtés
 Para raíces superiores, ambos lados
 Per radici superiori, ambedue i lati

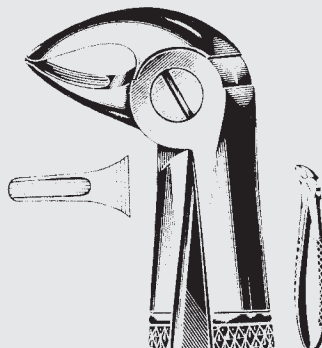

80-6303-09

Fig. 33S

Für untere Schneidezähne und Wurzeln, beide Seiten
 For lower incisors and roots, either side
 Pour incisives et racines inférieures, des deux côtés
 Para incisivos y raíces inferiores, ambos lados
 Per incisivi e radici inferiori, ambedue i lati

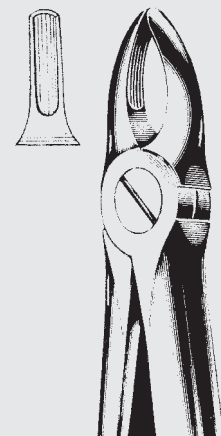

80-6307-00

Fig. 37

Für obere Schneide- und Eckzähne
 For upper incisors and canines
 Pour incisives et canines supérieures
 Para incisivos y caninos superiores
 Per incisivi e canini superiori

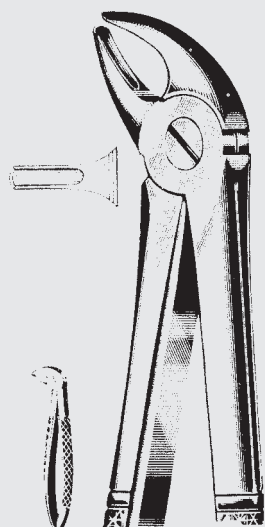

80-6308-00

Fig. 38

Für untere Schneide- und Eckzähne
 For lower incisors and canines
 Pour incisives et canines inférieures
 Para incisivos y caninos inferiores
 Per incisivi e canini inferiori

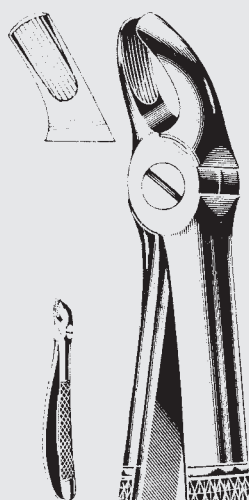

80-6309-00

Fig. 39

Für obere Molaren, beide Seiten
 For upper molars, either side
 Pour molaires supérieures, des deux côtés
 Para molares superiores, ambos lados
 Per molari superiori, ambedue i lati

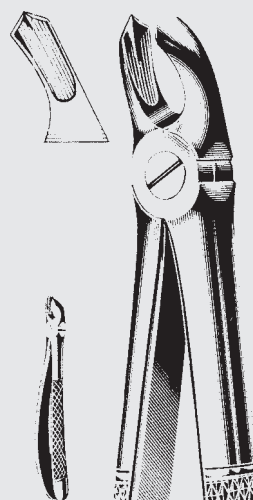

80-6309-01

Fig. 39A

Für obere Molaren, beide Seiten
 For upper molars, either side
 Pour molaires supérieures, des deux côtés
 Para molares superiores, ambos lados
 Per molari superiori, ambedue i lati

Kinder-Zahnzangen, englische Form
 Extracting Forceps for Children, English Pattern
 Daviers pour enfants, modèle anglais
 Fórceps para niños, forma inglesa
 Tenaglia per bambini, forma inglese

ZAHNZANGEN

EXTRACTING FORCEPS

DAVIERS

FÓRCEPS DE EXTRACCIÓN

TENAGLIE

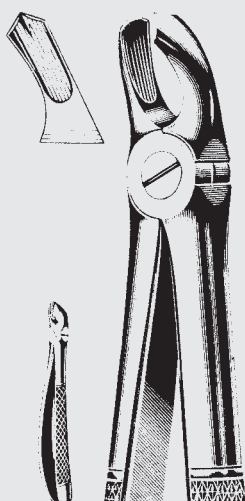

80-6309-05

Fig. 39L

Für obere Molaren, links
 For upper molars, left side
 Pour molaires supérieures, côté gauche
 Para molares superiores, lado izquierdo
 Per molari superiori, sinistri

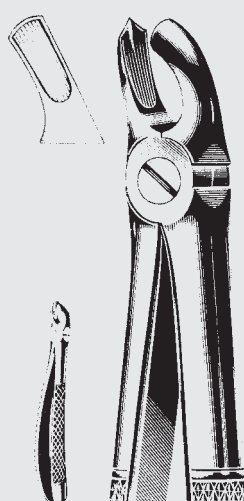

80-6309-08

Fig. 39R

Für obere Molaren, rechts
 For right upper molars
 Pour molaires supérieures, côté droit
 Para molares superiores, lado derecho
 Per molari superiori destri

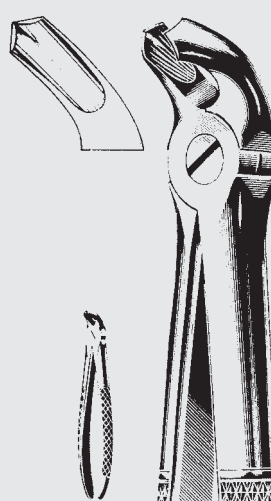

80-6400-00

Fig. 40

Für untere Molaren, beide Seiten
 For lower molars, either side
 Pour molaires inférieures, des deux côtés
 Para molares inferiores, ambos lados
 Per molari inferiori, ambedue i lati



80-6400-00

80.17

Kinder-Zahnzangen, englische Form
 Extracting Forceps for Children, English Pattern
 Daviers pour enfants, modèle anglais
 Fórceps para niños, forma inglesa
 Tenaglia per bambini, forma inglese

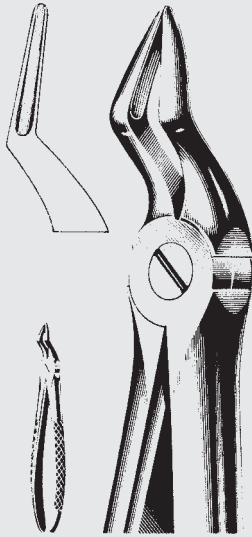

80-6501-09
 Fig. 51S

Für obere Wurzeln, beide Seiten
 For upper roots, either side
 Pour racines supérieures, des deux côtés
 Para raíces superiores, ambos lados
 Per radici superiori, ambedue i lati

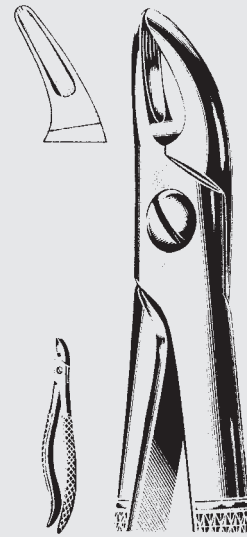

LAWRENCE READ
 80-6706-09
 Fig. 76S

Für obere Wurzeln, beide Seiten
 For upper roots, either side
 Pour racines supérieures, des deux côtés
 Para raíces superiores, ambos lados
 Per radici superiori, ambedue i lati

ZAHNZANGEN

EXTRACTING FORCEPS

DAVIERS

FÓRCEPS DE EXTRACCIÓN

TENAGLIE

KLEIN Kinderzahnzangen mit Feder
 KLEIN Extracting Forceps, children's, with spring
 KLEIN daviers pour enfants, avec ressort
 KLEIN fórceps de extracción para niños, con resorte
 KLEIN tenaglia per bambini, con molla

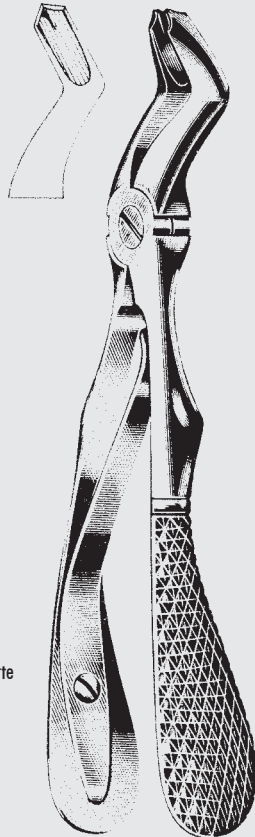

KLEIN
 80-7003-00
 Fig. 3

Für obere Molaren
 For upper molars
 Pour molaires supérieures
 Para molares superiores
 Per molari superiori

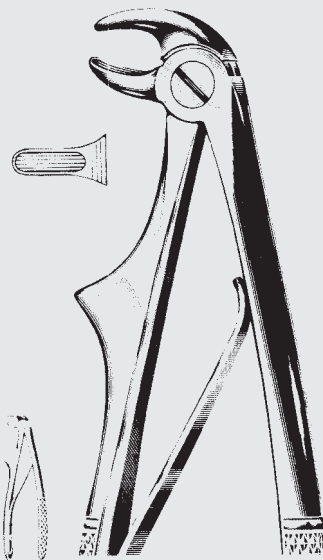

KLEIN
 80-7005-00
 Fig. 5

Für untere Schneidezähne
 For lower incisors
 Pour incisives inférieures
 Para incisivos inferiores
 per incisivi inferiori

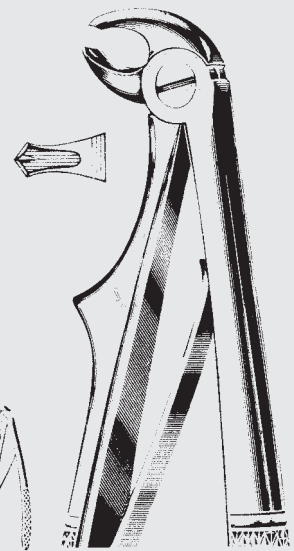

KLEIN
 80-7006-00
 Fig. 6

Für untere Molaren
 For lower molars
 Pour molaires inférieures
 Para molares inferiores
 Per molari inferiori

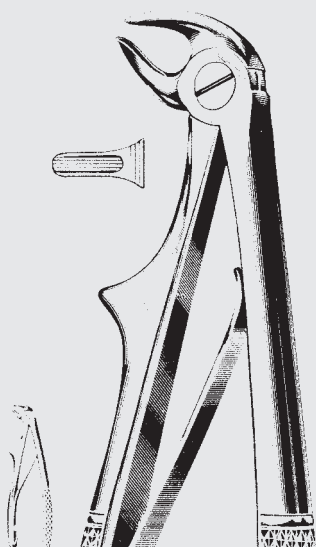

KLEIN
80-7007-00
Fig. 7

Für untere Wurzeln
For lower roots
Pour racines inférieures
Para raíces inferiores
Per radici inferiori

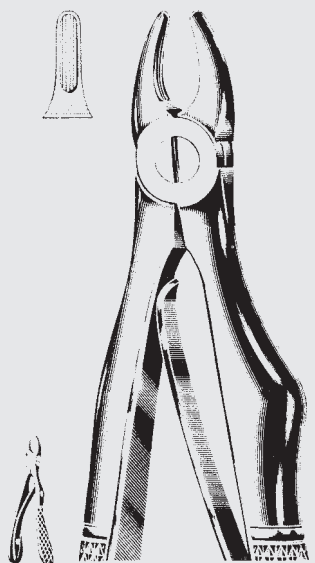

KLEIN
80-7307-00
Fig. 137

Für obere Schneide- und Eckzähne
For upper incisors and canines
Pour incisives et canines supérieures
Para incisivos y caninos superiores
Per incisivi e canini superiori

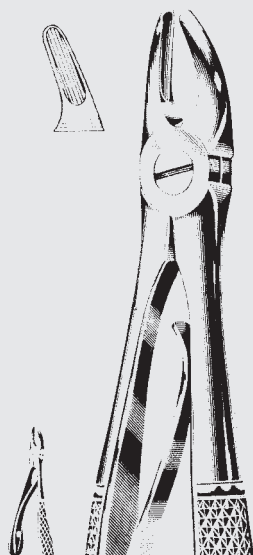

KLEIN
80-7309-00
Fig. 139

Für obere Prämolaren
For upper bicusps
Pour prémolaires supérieures
Para premolares superiores
Per premolari superiori

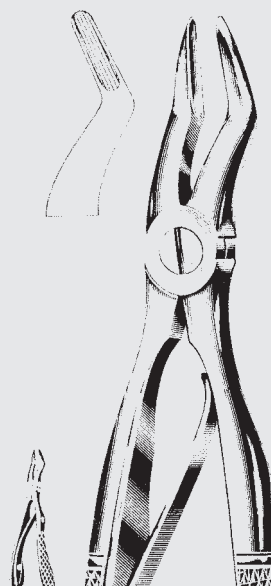

KLEIN
80-7501-09
Fig. 51S

Für untere Molaren, beide Seiten
For lower molars, either side
Pour molaires inférieures, des deux côtés
Para molares inferiores, ambos lados
Per molari inferiori, ambedue i lati

KLEIN Kinderzahnzangen mit Feder
KLEIN Extracting Forceps, Children's, with Spring
KLEIN daviers pour enfants, avec ressort
KLEIN fórceps de extracción para niños, con resorte
KLEIN tenaglie per bambini, con molla

ZAHNZANGEN

EXTRACTING FORCEPS

DAVIERS

FÓRCEPS DE EXTRACCIÓN

TENAGLIE



80-7501-09

80.19

Kinderzahnzangen, amerikanische Form
 Extracting Forceps, Children's, American Pattern
 Daviers pour enfants, forme américaine
 Fórceps de extracción para niños, forma americana
 Tenaglie per bambini, forma americana

ZAHNZANGEN

EXTRACTING FORCEPS

DAVIERS

FÓRCEPS DE EXTRACCIÓN

TENAGLIE

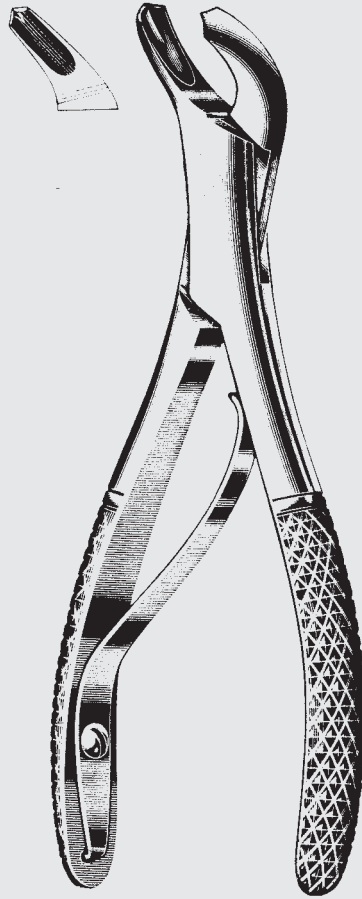

80-8107-09

Fig. 17 SK

Für untere Molaren, beide Seiten
 For lower molars, either side
 Pour molaires inférieures, des deux côtés
 Para molares inferiores, ambos lados
 Per molari inferiori, ambedue i lati

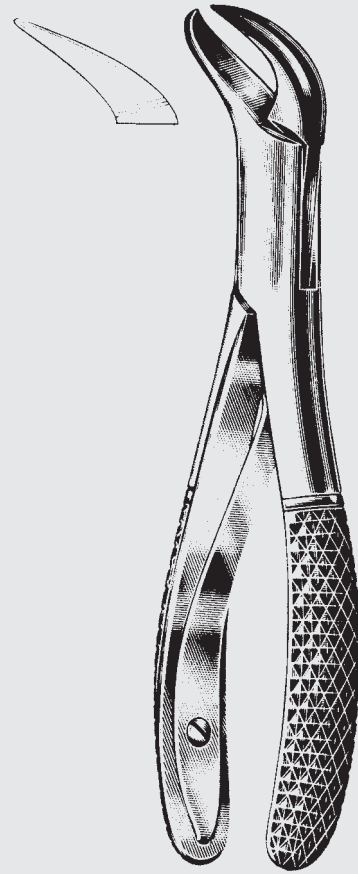

80-8203-09

Fig. 23 SK

Für untere Molaren, beide Seiten
 For lower molars, either side
 Pour molaires inférieures, des deux côtés
 Para molares inferiores, ambos lados
 Per molari inferiori, ambedue i lati

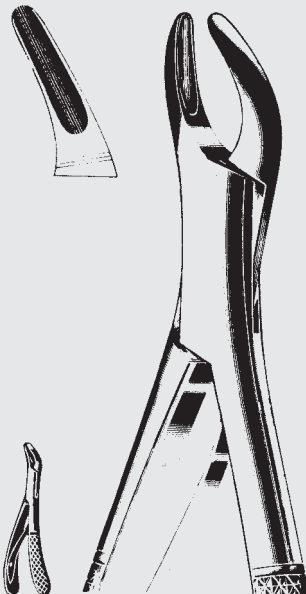

80-8500-09

Fig. 150 SK

Für obere Zähne und Wurzeln
 For upper teeth and roots
 Pour dents et racines supérieures
 Para dientes y raíces superiores
 Per denti e radici superiori

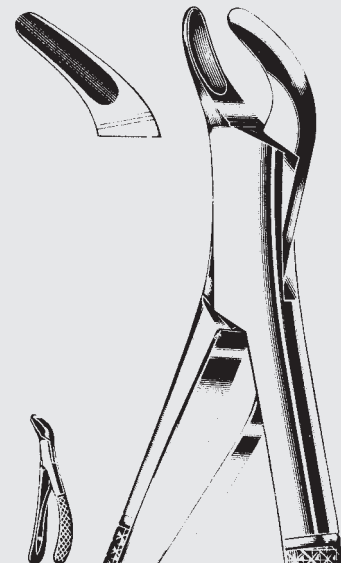

80-8501-09

Fig. 151 SK

Für untere Zähne und Wurzeln
 For lower teeth and roots
 Pour dents et racines inférieures
 Para dientes y raíces inferiores
 Per denti e radici inferiori

ZAHNZANGEN

EXTRACTING FORCEPS

DAVIERS

FÓRCEPS DE EXTRACCIÓN

TENAGLIE

Amerikanische Form
 American Pattern
 Forme américaine
 Forma americana
 Forma americana

ZAHNZANGEN

EXTRACTING FORCEPS

DAVIERS

FÓRCEPS DE EXTRACCIÓN

TENAGLIE

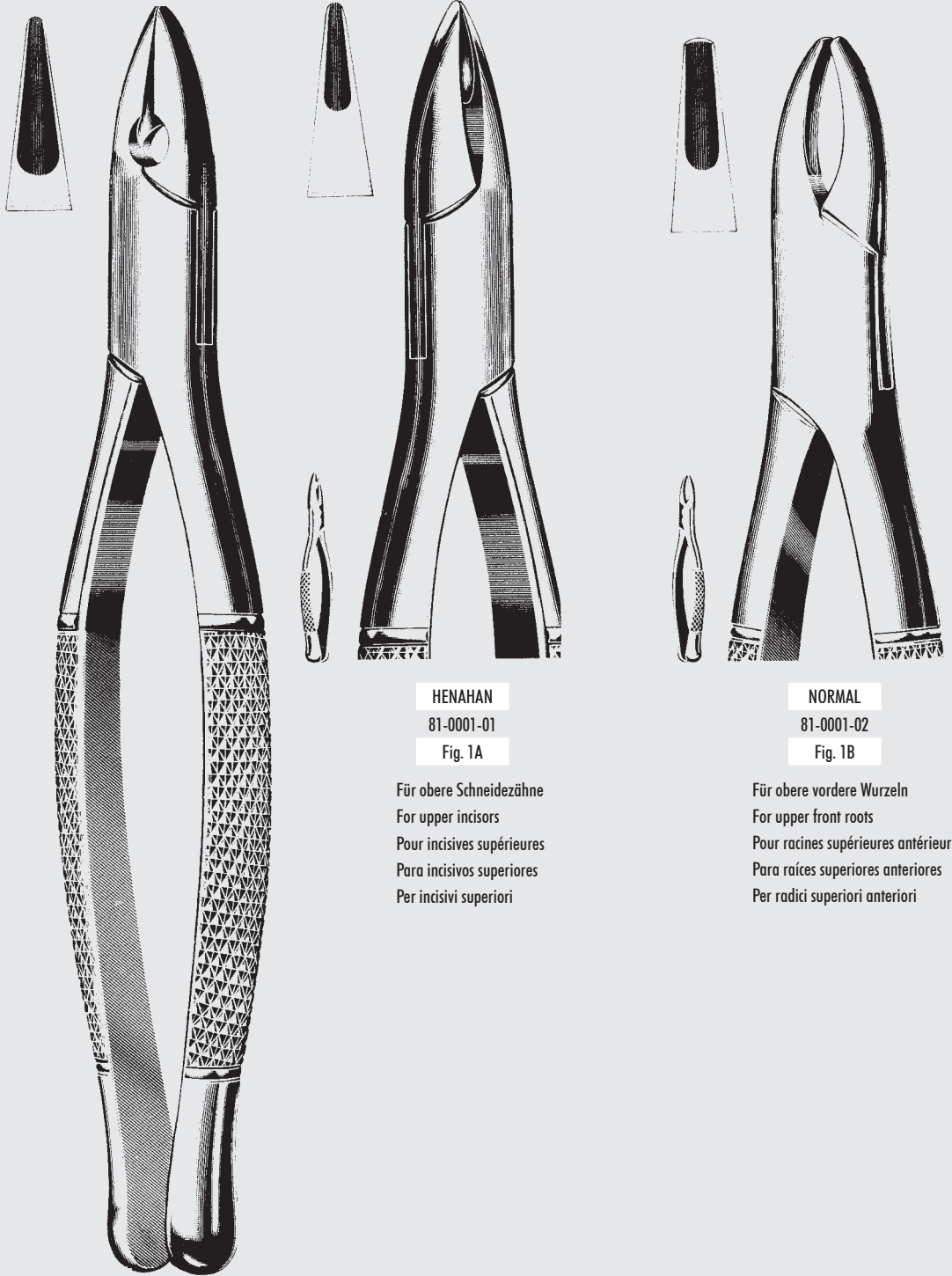

STANDARD

81-0001-00

Fig. 1

Für obere Schneide- und Eckzähne
 For upper incisors, laterals and cuspids
 Pour incisives et canines supérieures
 Para incisivos y caninos superiores
 Per incisivi e canini superiori

HENAHAN

81-0001-01

Fig. 1A

Für obere Schneidezähne
 For upper incisors
 Pour incisives supérieures
 Para incisivos superiores
 Per incisivi superiori

NORMAL

81-0001-02

Fig. 1B

Für obere vordere Wurzeln
 For upper front roots
 Pour racines supérieures antérieures
 Para raíces superiores anteriores
 Per radici superiori anteriori

ZEPF®
 &
 INSTRUMENTS

81-0001-00

81.2

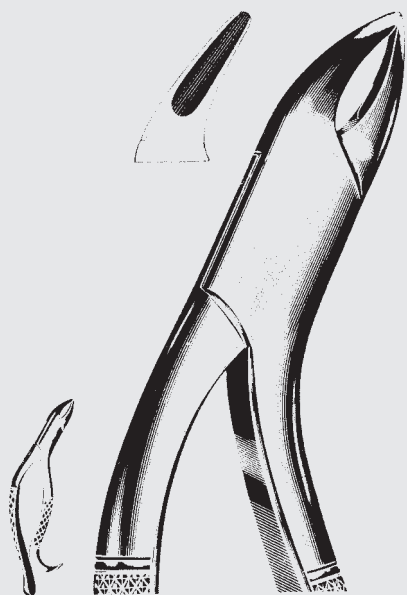

MILWAUKEE
81-0003-00
Fig. 3

Für untere Prämolaren
For lower bicuspid
Pour prémolaires inférieures
Para premolares inferiores
Per premolari inferiori

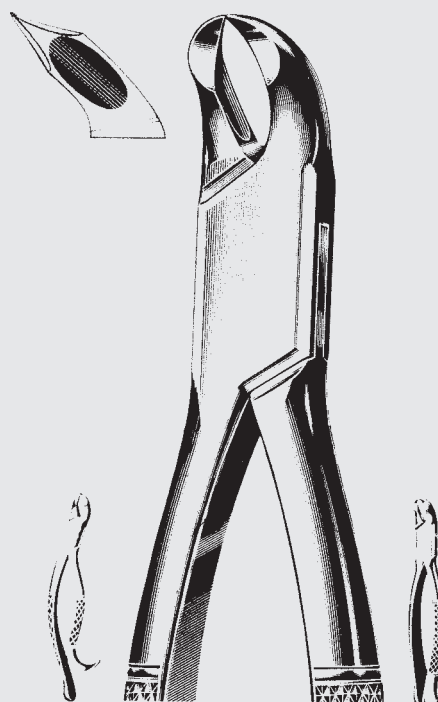

WOODWARD
81-0003-04 81-0003-09
Fig. 3FH Fig. 3FS

Für untere Molaren
For lower molars
Pour molaires inférieures
Para molares inferiores
Per molari inferiori

Amerikanische Form
American Pattern
Forme américaine
Forma americana
Forma americana

ZAHNZANGEN

EXTRACTING FORCEPS

DAVIERS

FÓRCEPS DE EXTRACCIÓN

TENAGLIE

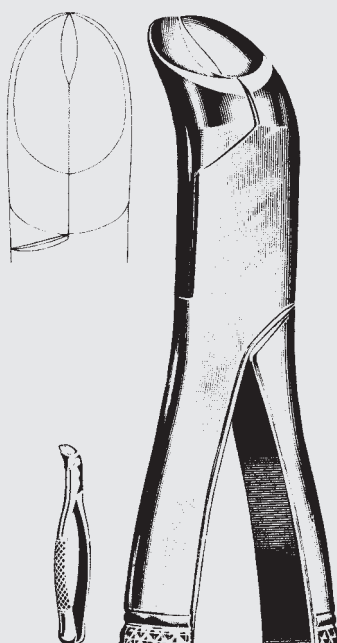

PHYSICK
81-0005-00
Fig. 5

Für untere Weisheitszähne, beide Seiten
For lower third molars, either side
Para cordales inferiores, ambos lados
Pour dents de sagesse inférieures, des deux côtés
Per denti del giudizio, ambedue i lati

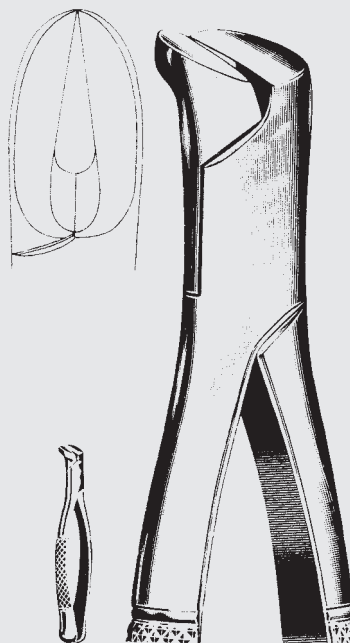

81-0006-00
Fig. 6

Spaltzange
Splitting or separating forceps
Pour séparer les racines
Para separar raíces
Per separare radici



81-0006-00
81.3

Amerikanische Form
 American Pattern
 Forme américaine
 Forma americana
 Forma americana

ZAHNZANGEN

EXTRACTING FORCEPS

DAVIERS

FÓRCEPS DE EXTRACCIÓN

TENAGLIE

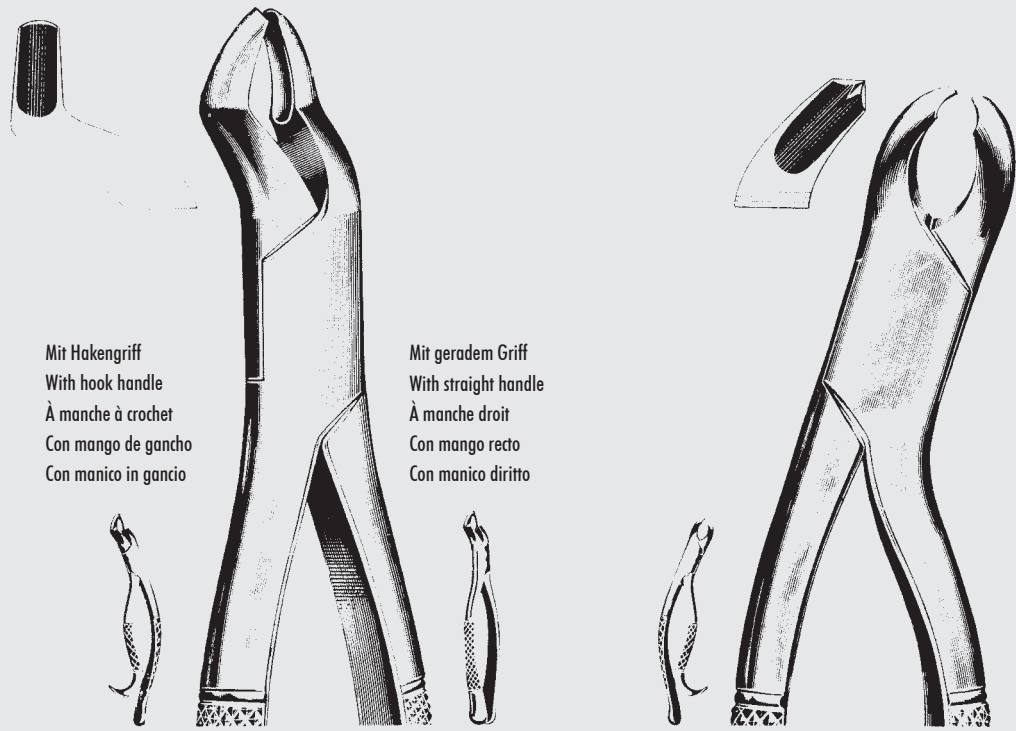

Mit Hakengriff
 With hook handle
 À manche à crochet
 Con mango de gancho
 Con manico in gancio

Mit geradem Griff
 With straight handle
 À manche droit
 Con mango recto
 Con manico diritto

81-0100-04

81-0100-09

Fig. 10H

Fig. 10S

HARRIS

81-0105-00

Fig. 15

Für obere Molaren, beide Seiten
 For upper molars, either side
 Pour molaires supérieures, des deux côtés
 Para molares superiores, ambos lados
 Per molari superiori, ambedue i lati

Für untere Molaren, beide Seiten
 For lower molars, either side
 Pour molaires inférieures, des deux côtés
 Para molares inferiores, ambos lados
 Per molari inferiori, ambedue i lati

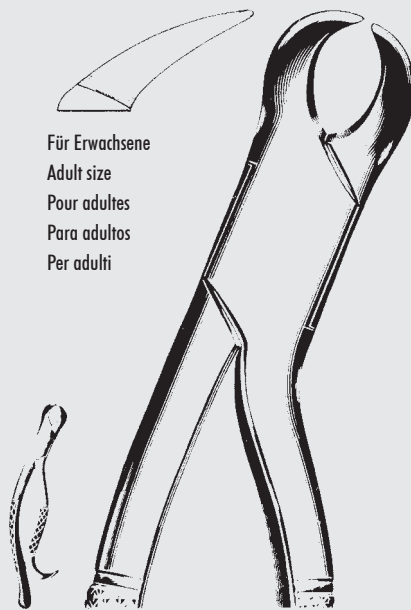

Für Erwachsene
 Adult size
 Pour adultes
 Para adultos
 Per adulti

81-0106-00

Fig. 16

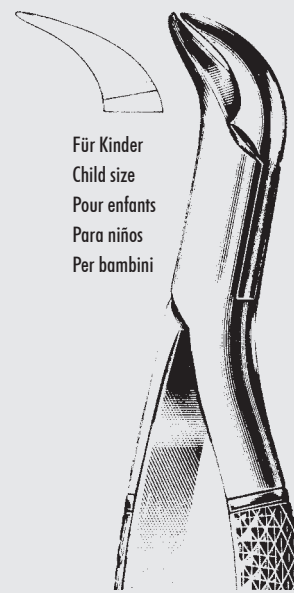

Für Kinder
 Child size
 Pour enfants
 Para niños
 Per bambini

81-0106-09

Fig. 16S

Für untere Molaren, beide Seiten, Kuhhornschnabel
 For lower molars, either side, with cow-horn beak
 Pour molaires inférieures, des deux côtés, en forme de corne de vache
 Para molares inferiores, ambos lados, forma cuerno de vaca
 Per molari inferiori, ambedue i lati, forma corno di vacca

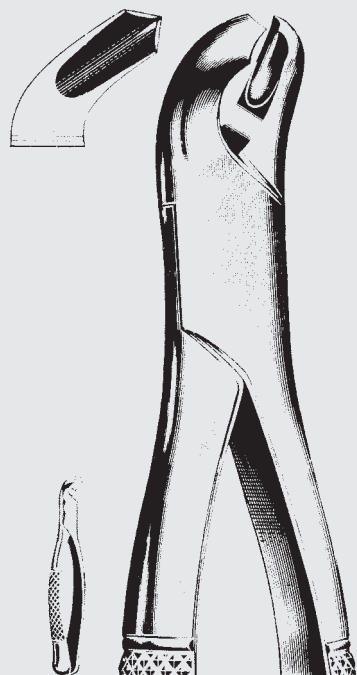

81-0107-00

Fig. 17

Für untere Molaren, beide Seiten
 For lower molars, either side
 Pour molaires inférieures, des deux côtés
 Para molares inferiores, ambos lados
 Per molari inferiori, ambedue i lati

Amerikanische Form
 American Pattern
 Forme américaine
 Forma americana
 Forma americana

ZAHNZANGEN

EXTRACTING FORCEPS

DAVIERS

FÓRCEPS DE EXTRACCIÓN

TENAGLIE

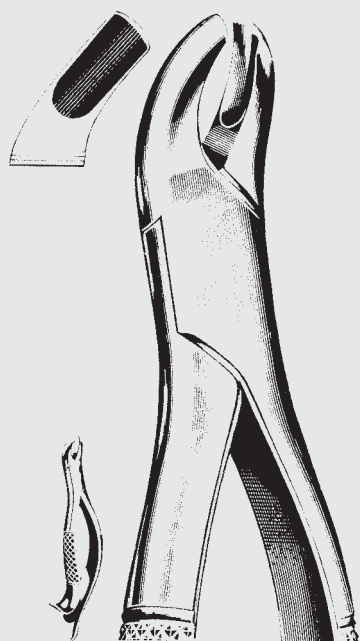

HARRIS

81-0108-05

Fig. 18L

links
 left side
 côté gauche
 izquierdo
 sinistro

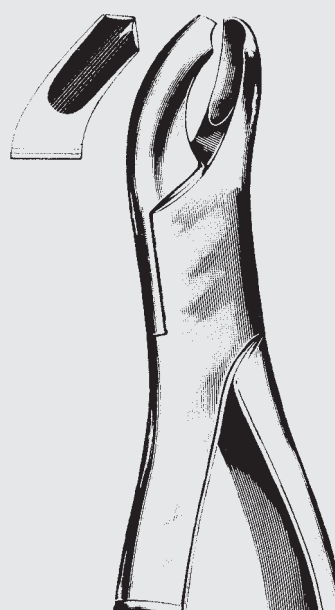

HARRIS

81-0108-08

Fig. 18R

rechts
 right side
 côté droit
 derecho
 destro

Für obere Molaren
 For upper molars
 Pour molaires supérieures
 Para molares superiores
 Per molari superiori



81-0108-08

81.5

Amerikanische Form
 American Pattern
 Forme américaine
 Forma americana
 Forma americana

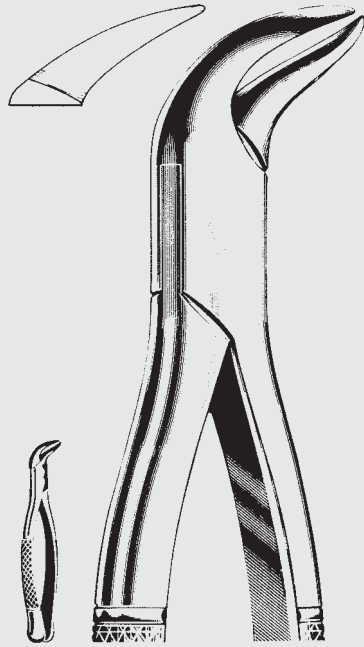

81-0203-00
 Fig. 23

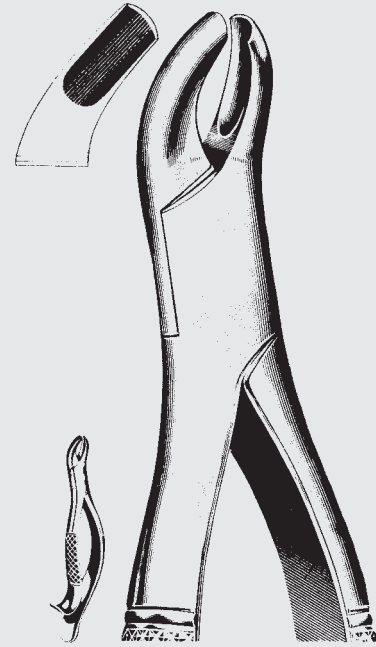

81-0204-00
 Fig. 24

ZAHNZANGEN

Für untere Molaren (Kuhhornschnabel), beide Seiten
 For lower molars, either side (cow horn beak)
 Pour molaires inférieures, des deux côtés (en forme de corne de vache)
 Para molares inferiores, ambos lados (con pico forma cuerno de vaca)
 Per molari inferiori, ambedue i lati (forma corno di vacca)

Für obere Molaren, beide Seiten
 For upper molars, either side
 Pour molaires supérieures, des deux côtés
 Para molares superiores, ambos lados
 Per molari superiori, ambedue i lati

EXTRACTING FORCEPS

DAVIERS

FÓRCEPS DE EXTRACCIÓN

TENAGLIE

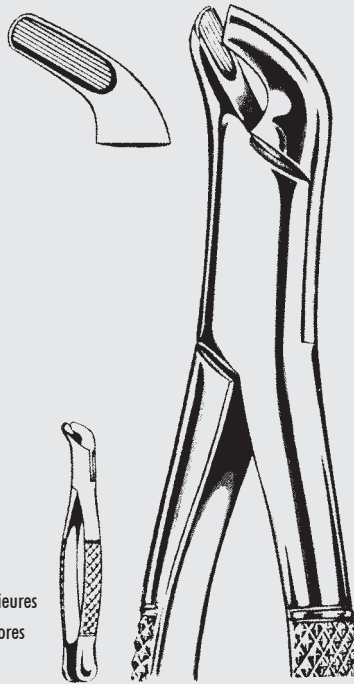

Für untere Molaren
 For lower molars
 Pour molaires inférieures
 Para molares inferiores
 Per molari inferiori

81-0207-00
 Fig. 27



Alveolarzange
 Alveolar forceps
 Davier alvéolaire
 Fórceps alveolar
 Tenaglia alveolare

PARMLY
 81-0302-00 81-0302-01
 Fig. 32 Fig. 32A

Für obere Molaren und Prämolaren, starker Schnabel
 For upper molars and bicuspid, strong beak
 Pour molaires et prémolaires supérieures, à bcs forts
 Para molares y premolares superiores, con pico fuerte
 Per molari e premolari superiori, con morso forte

Für obere Molaen, Prämolaren und Wurzeln, schlanker Schnabel
 For upper molars, bicuspid and roots, slender beak
 Pour molaires, prémolaires et racines supérieures, à bcs étroits
 Para molares, premolares y raíces superiores, con pico angosto
 Per molari, premolari e radici superiori, con morso fino

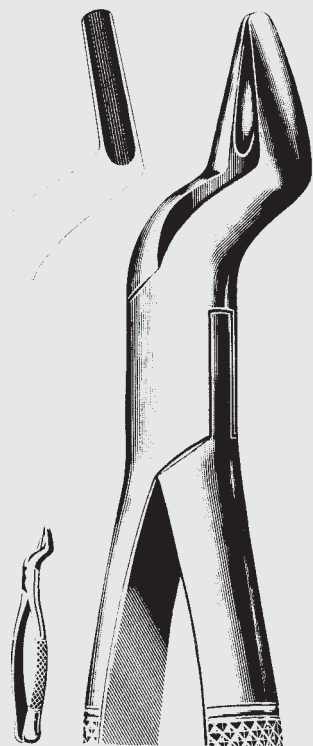

81-0305-00

Fig. 35

Für obere Wurzeln, beide Seiten
 For upper roots, either side
 Pour racines supérieures, des deux côtés
 Para raíces superiores, ambos lados
 Per radici superiori, ambedue i lati

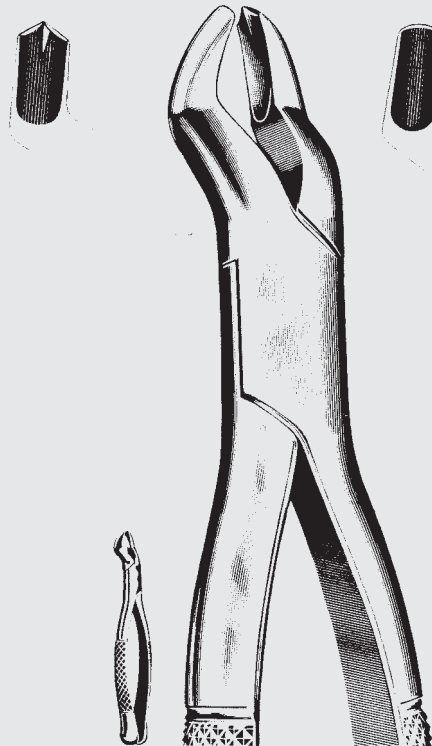

81-0503-05

Fig. 53L

Für obere Molaren, links
 For left upper molars
 Pour molaires supérieures, côté gauche
 Para molares superiores, lado izquierdo
 Per molari superiori sinistri



81-0503-08

Fig. 53R

für obere Molaren, rechts
 For right upper molars
 Pour molaires supérieures, côté droit
 Para molares superiores, lado derecho
 Per molari superiori, destri

Amerikanische Form
 American Pattern
 Forme américaine
 Forma americana
 Forma americana

ZAHNZANGEN

EXTRACTING FORCEPS

DAVIERS

FÓRCEPS DE EXTRACCIÓN

TENAGLIE



81-0602-00

Fig. 62

Universalzange für obere Zähne und Wurzeln, auch für Kinder
 Universal forceps for upper teeth and roots, also for children
 Davier universel pour dents et racines supérieures, aussi pour enfants
 Fórceps universal para dientes y raíces superiores, también para niños
 Tenaglia universale per denti e radici superiori, anche per bambini

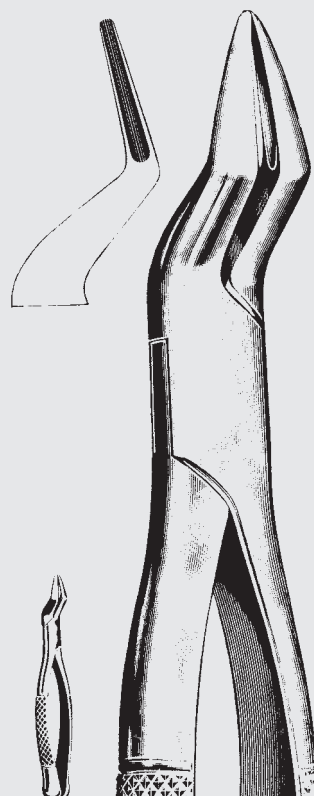

81-0605-00

Fig. 65

Für obere Schneidezähne und Wurzeln, langer schlanker Schnabel
 For upper incisors and roots, long slender beak
 Pour incisives et racines supérieures, à bec longs et étroits
 Para incisivos y raíces superiores, con pico largo y angosto
 Per incisivi e radici superiori, con morso lungo e stretto



81-0605-00

81.7

Amerikanische Form
 American Pattern
 Forme américaine
 Forma americana
 Forma americana

ZAHNZANGEN

EXTRACTING FORCEPS

DAVIERS

FÓRCEPS DE EXTRACCIÓN

TENAGLIE



TOMES
 81-0609-00
 Fig. 69

Für Wurzelsplinter und kleine Wurzeln, oben und unten
 For root fragments and small roots, upper and lower
 Pour fragments de racines et petites racines, sup. et inf.
 Para fragmentos de raíces y raíces pequeñas, sup. e inf.
 Per frammenti di radici e radici piccole, sup. e inf.

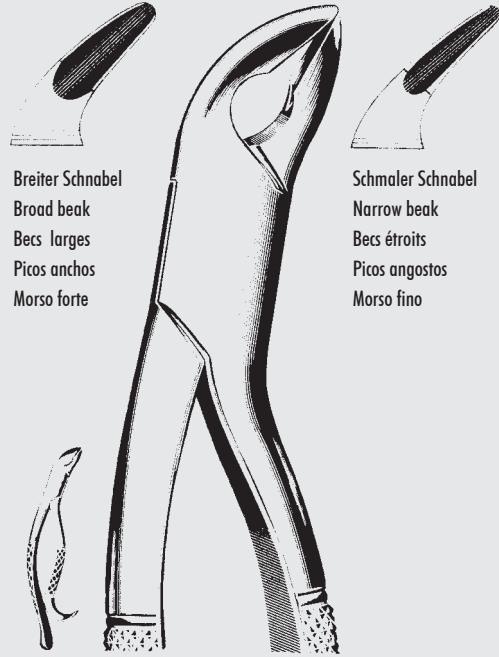

Breiter Schnabel
 Broad beak
 Becs larges
 Picos anchos
 Morso forte

Schmaler Schnabel
 Narrow beak
 Becs étroits
 Picos angostos
 Morso fino

THOMAS
 81-0805-00 81-0805-01
 Fig. 85 Fig. 85A

Alveolarzange für untere Molaren, Eck- und Schneidezähne
 Alveolar forceps for lower molars, cuspids and bicuspids
 Davier alvéolaire pour molaires, canines et incisives inférieures
 Fórceps alveolar para molares, caninos e incisivos inferiores
 Tenaglia alveolare per molari, canini e incisivi inferiori

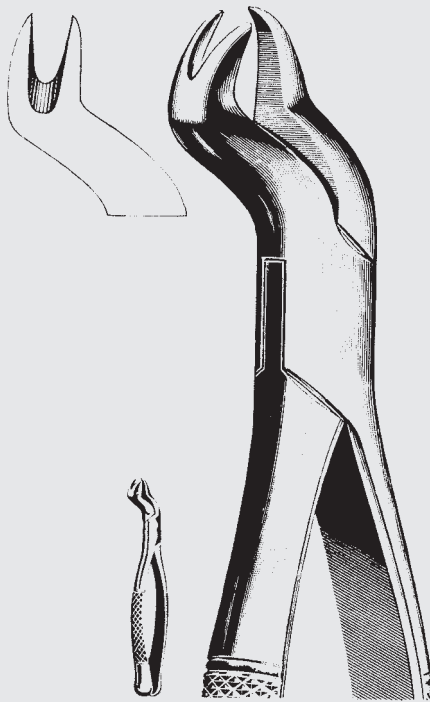

NEVIUS
 81-0808-05
 Fig. 88L

Für obere Molaren, links
 For left upper molars
 Pour molaires supérieures, côté gauche
 Para molares superiores, lado izquierdo
 Per molari superiori sinistri

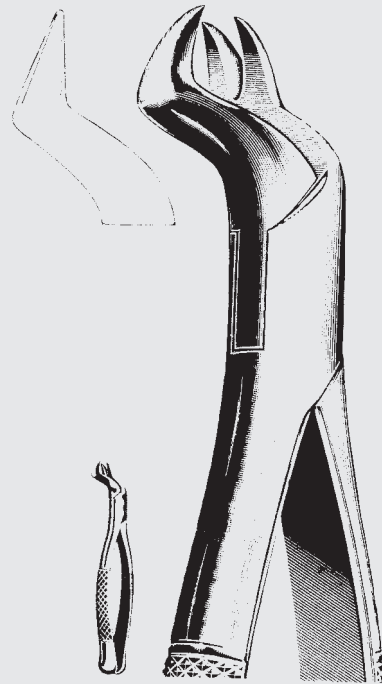

NEVIUS
 81-0808-08
 Fig. 88R

Für obere Molaren, rechts
 For right upper molars
 Pour molaires supérieures, côté droit
 Para molares superiores, lado derecho
 Per molari superiori destri

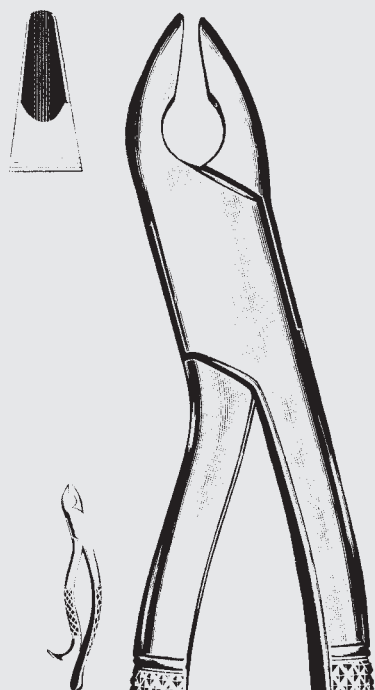

KELLS
81-0909-01
Fig. 99A

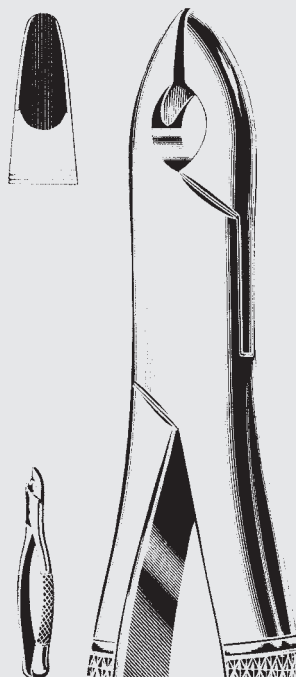

KELLS
81-0909-03
Fig. 99C

Für obere Prämolaren, Eck- und Schneidezähne
For upper bicuspid, cuspids and incisors
Pour prémolaires, canines et incisives supérieures
Para premolares, caninos e incisivos superiores
Per premolari, canini e incisivi superiori

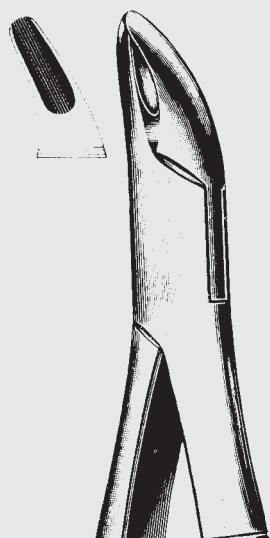

HULL
81-1001-00
Fig. 101

Universalzange für Prämolaren und Milchzähne
Universal forceps for bicuspid and milk-teeth
Daviers universel pour prémolaires et dents de lait
Fórceps universal para premolares y dientes temporales
Tenaglia universale per premolari e denti di latte

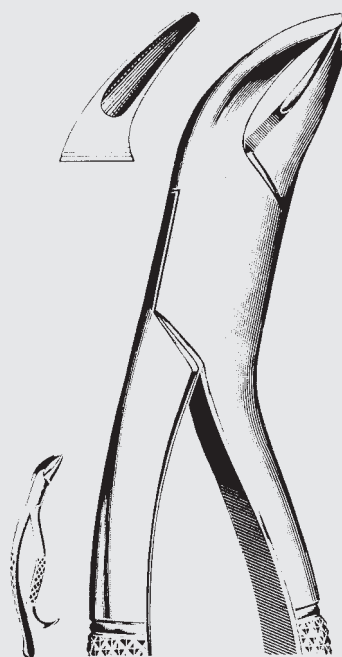

81-1003-00
Fig. 103

Für untere Prämolaren, Schneidezähne und Wurzeln, beide Seiten
For lower bicuspid, incisors, and roots, either side
Pour prémolaires, incisives et racines inférieures, des deux côtés
Para premolares, incisivos y raíces inferiores, ambos lados
Per premolari, incisivi e radici inferiori, ambedue i lati

Amerikanische Form
American Pattern
Forme américaine
Forma americana
Forma americana

ZAHNZANGEN

EXTRACTING FORCEPS

DAVIERS

FÓRCEPS DE EXTRACCIÓN

TENAGLIE



81-1003-00

81.9

Amerikanische Form
 American Pattern
 Forme américaine
 Forma americana
 Forma americana

ZAHNZANGEN

EXTRACTING FORCEPS

DAVIERS

FÓRCEPS DE EXTRACCIÓN

TENAGLIE



Mit Hakengriff
 With hook handle
 A manche à crochet
 Con mango de gancho
 Con manico in gancio

Mit geradem Griff
 With straight handle
 A manche droit
 Con mango recto
 Con manico diritto

NEVIUS	
81-1100-04	81-1100-09
Fig. 10H	Fig. 10S

Für obere Prämolaren und Eckzöhne, kräftig
 For upper cuspids and bicuspid, powerful pattern
 Pour prémolaires et canines supérieures, modèle fort
 Para premolares y caninos superiores, modelo fuerte
 Per premolari e canini superiori, modello forte

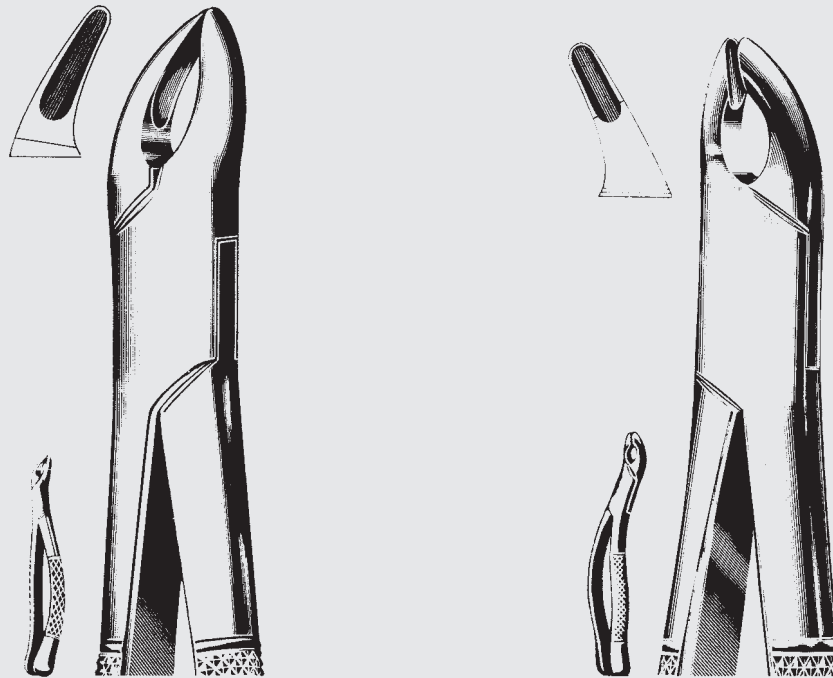

CRYER
 81-1500-00
 Fig. 150

CRYER
 81-1500-01
 Fig. 150A

Für obere Prämolaren, Schneidezähne und Wurzeln
 For upper bicuspid, incisors, and roots
 Pour prémolaires, incisives et racines supérieures
 Para premolares, incisivos y raíces superiores
 Per premolari, incisivi e radici superiori

Für obere Prämolaren, Schneidezähne und Wurzeln, modifiziert
 For upper bicuspid, incisors, and roots, modified
 Pour prémolaires, incisives et racines supérieures, modifié
 Para premolares, incisivos y raíces superiores, modificado
 Per premolari, incisivi e radici superiori, modificato

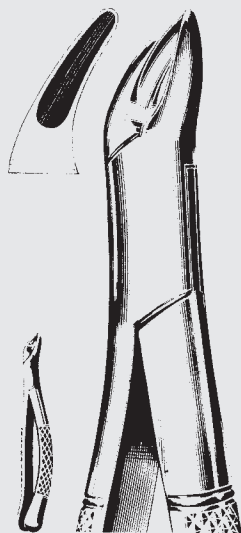

CRYER
81-1500-09
Fig. 150S

Für obere Prämolaren, Schneidezähne und Wurzeln
For upper bicuspid, incisors, and roots
Pour prémolaires, incisives et racines supérieures
Para premolares, incisivos y raíces superiores
Per premolari, incisivi e radici superiori

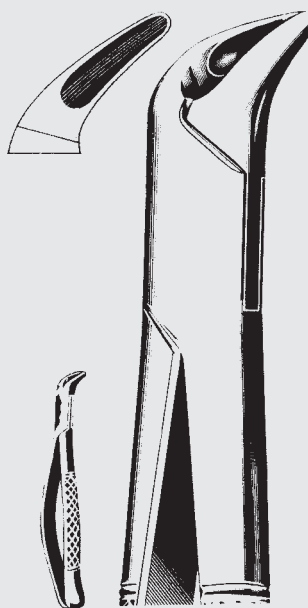

CRYER
81-1501-00
Fig. 151

Für untere Prämolaren, Schneidezähne und Wurzeln
For lower bicuspid, incisors, and roots
Pour prémolaires, incisives et racines inférieures
Para premolares, incisivos y raíces inferiores
Per premolari, incisivi e radici inferiori

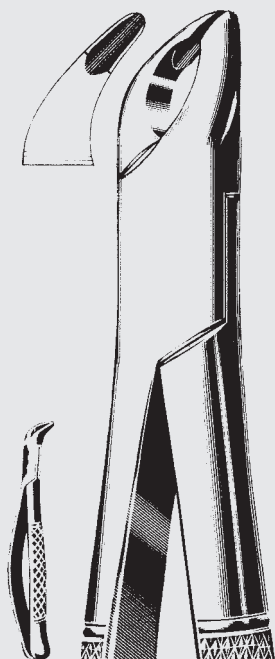

CRYER
81-1501-01
Fig. 151A

Für untere Prämolaren, Schneidezähne und Wurzeln, modifiziert
For lower bicuspid, incisors, and roots, modified
Pour prémolaires, incisives et racines inférieures, modifié
Para premolares, incisivos y raíces inferiores, modificado
Per premolari, incisivi e radici inferiori, modificato

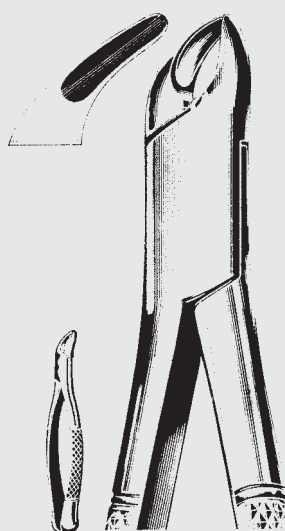

CRYER
81-1501-09
Fig. 151S

Für untere Prämolaren, Schneidezähne und Wurzeln
For lower bicuspid, incisors, and roots
Pour prémolaires, incisives et racines inférieures
Para premolares, incisivos y raíces inferiores
Per premolari, incisivi e radici inferiori

Amerikanische Form
American Pattern
Forme américaine
Forma americana
Forma americana

ZAHNZANGEN

EXTRACTING FORCEPS

DAVIERS

FÓRCEPS DE EXTRACCIÓN

TENAGLIE



81-1501-09

81.11

Amerikanische Form
American Pattern
Forme américaine
Forma americana
Forma americana

ZAHNZANGEN

EXTRACTING FORCEPS

DAVIERS

FÓRCEPS DE EXTRACCIÓN

TENAGLIE

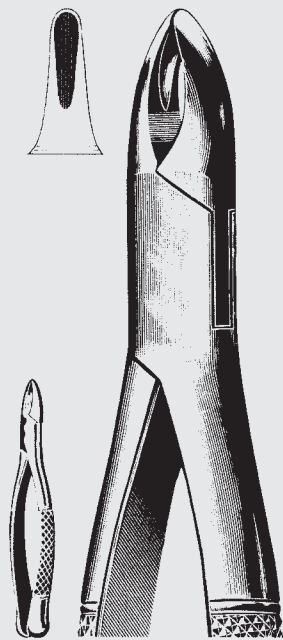

81-2001-00

Fig. 201

Für obere Prämolaren, Schneide- und Eckzähne, beide Seiten
For upper bicuspid, cuspids, and incisors, either side
Pour prémolaires, incisives et canines supérieures, des deux côtés
Para premolares, incisivos y caninos superiores, ambos lados
Per premolari, incisivi e canini superiori, ambedue i lati

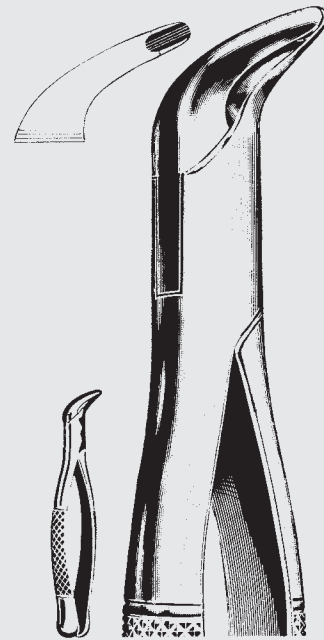

81-2003-00

Fig. 203

Für untere Prämolaren, Schneidezähne und Wurzeln, beide Seiten
For lower bicuspid, incisors, and roots, either side
Pour prémolaires, incisives et racines inférieures, des deux côtés
Para premolares, incisivos y raíces inferiores, ambos lados
Per premolari, incisivi e radici inferiori, ambedue i lati



Mit Hakengriff
With hook handle
Avec manche à crochet
Con mango de gancho
Con manico in gancio

Mit geradem Griff
With straight handle
Avec manche droit
Con mango recto
Con manico diritto

81-2100-04

Fig. 210H

81-2100-09

Fig. 210S

Für obere Weisheitszähne, beide Seiten
For upper wisdoms, either side
Pour dents de sagesse supérieures, des deux côtés
Para cordales superiores, ambos lados
Per denti del giudizio superiori, ambedue i lati

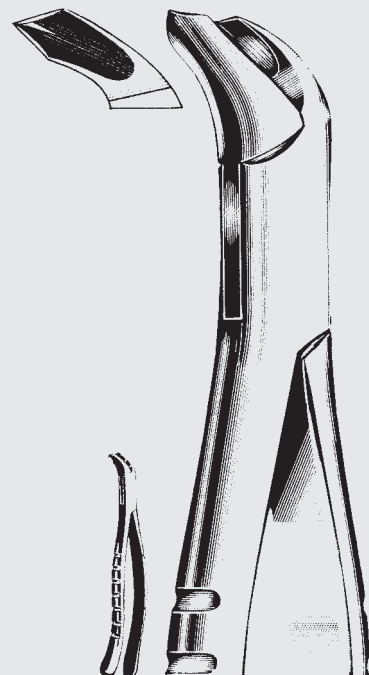

81-2107-00

Fig. 217

Für untere Molaren, beide Seiten
For lower molars, either side
Pour molaires inférieures, des deux côtés
Para molares inferiores, ambos lados
Per molari inferiori, ambedue i lati

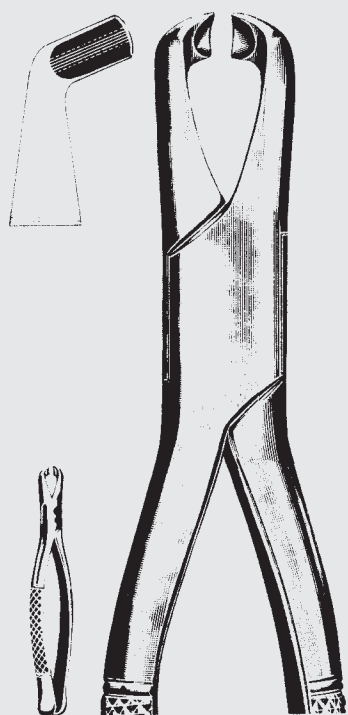

81-2202-00

Fig. 222

Für untere Weisheitszähne, beide Seiten
 For lower wisdoms, either side
 Pour dents de sagesse inférieures, des deux côtés
 Para cordales inferiores, ambos lados
 Per denti del giudizio inferiori, ambedue i lati

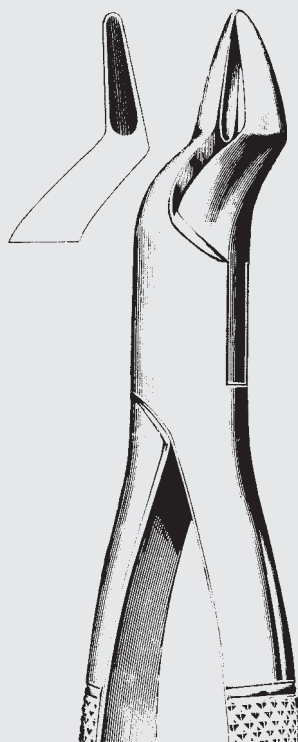

81-2806-00

Fig. 286

Für obere Wurzeln, Prämolaren und Schneidezähne, beide Seiten
 For upper roots, bicuspid, and incisors, either side
 Pour racines, prémolaires et incisives supérieures, des deux côtés
 Para raíces, premolares e incisivos superiores, ambos lados
 Per radici, premolari e incisivi superiori, ambedue i lati

Amerikanische Form
 American Pattern
 Forme américaine
 Forma americana
 Forma americana

ZAHNZANGEN

EXTRACTING FORCEPS

DAVIERS

FÓRCEPS DE EXTRACCIÓN

TENAGLIE

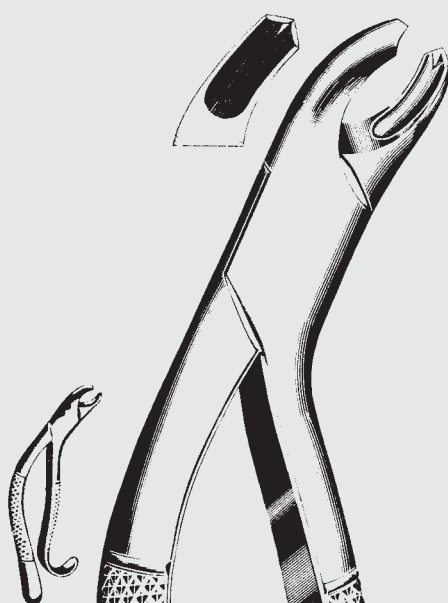

81-2807-00

Fig. 287

Für untere Molaren, beide Seiten
 For lower molars, either side
 Pour molaires inférieures, des deux côtés
 Para molares inferiores, ambos lados
 Per molari inferiori, ambedue i lati

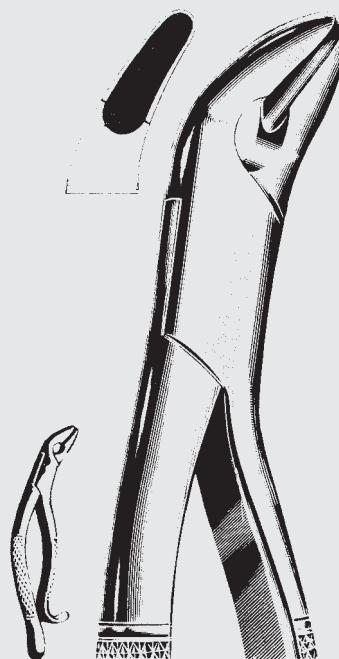

81-2808-00

Fig. 288

Für untere Prämolaren und Eckzähne, beide Seiten
 For lower bicuspid and canines, either side
 Pour molaires et canines inférieures, des deux côtés
 Para molares y caninos inferiores, ambos lados
 Per molari e canini inferiori, ambedue i lati



81-2808-00

81.13

Wurzelsplitterzangen
 Root Fragment Forceps
 Daviers à fragments de racines
 Fórceps para fragmentos de raíces
 Tenaglie per frammenti di radici

ZAHNZANGEN

EXTRACTING FORCEPS

DAVIERS

FÓRCEPS DE EXTRACCIÓN

TENAGLIE

Universal-Modelle
 Universal Patterns
 Modèles universels
 Modelos universales
 Modelli universali

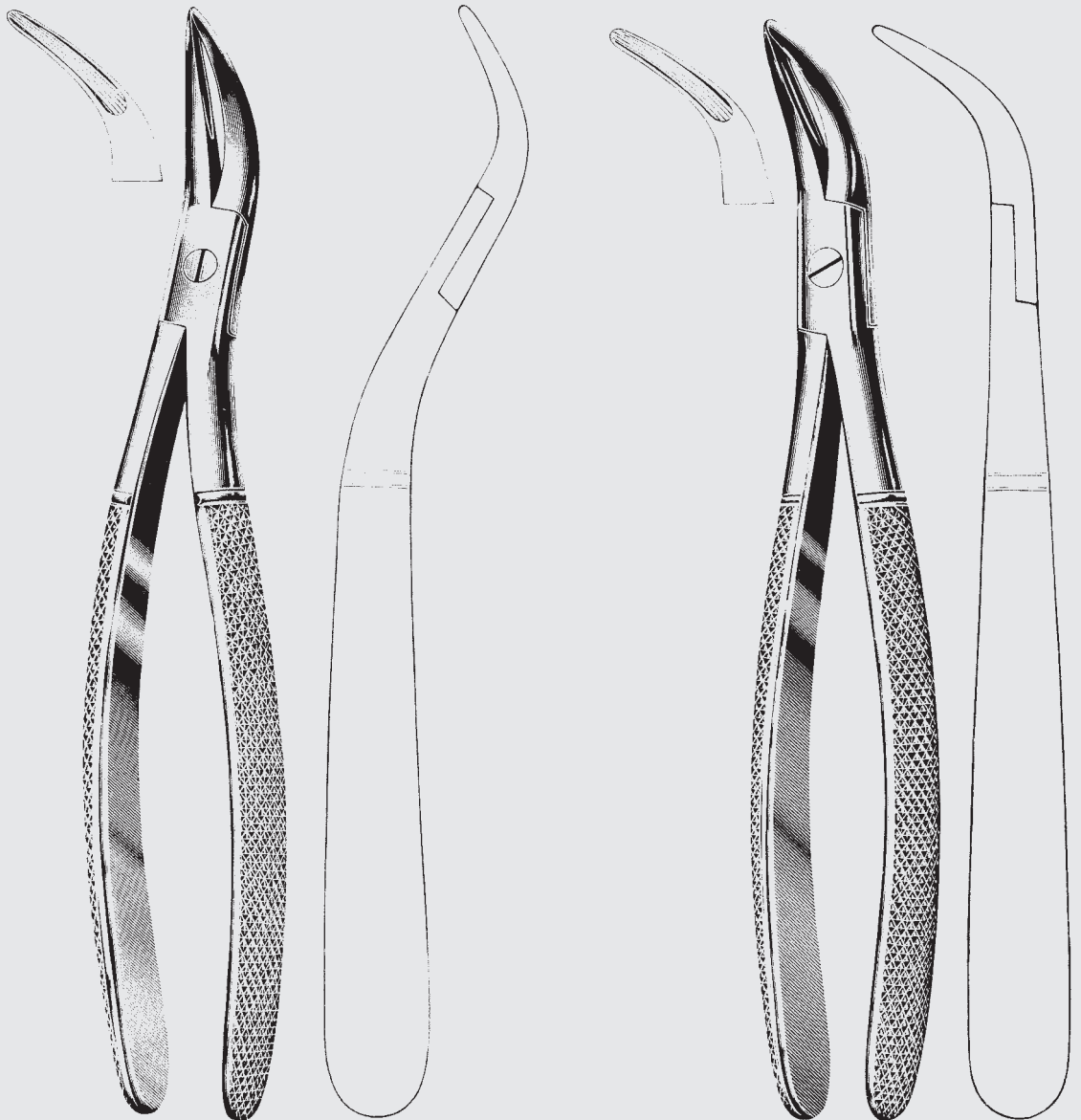

WITZEL

81-5001-00

Für obere Zähne
 For upper teeth
 Pour dents supérieures
 Para dientes superiores
 Per denti superiori

WITZEL

81-5002-00

Für untere Zähne
 For lower teeth
 Pour dents inférieures
 Para dientes inferiores
 Per denti inferiori

ZEPF[®]
α
 INSTRUMENTS

81-5001-00

81.14

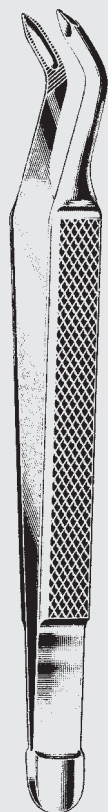

ALBRECHT
81-8101-16
Fig. 1

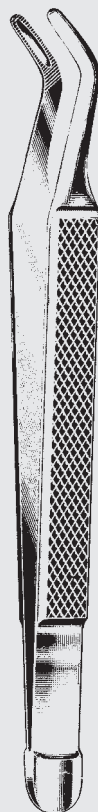

ALBRECHT
81-8102-16
Fig. 2

Milchzahnpinzetten
Forceps for Temporary Teeth
Pinces à dents de lait
Pinzas para dientes de leche
Pinze per denti di latte

EXTRAKTION

EXTRACTION

EXTRACTION

EXTRACCIÓN

ESTRAZIONE



MORRISON
81-8200-00 - 81-8200-03



81-8200-00
Fig. 0



81-8200-01
Fig. 1



81-8200-02
Fig. 2



81-8200-03
Fig. 3

Wurzelschrauben
Root Screws
Vis à racines
Tornillos para raíces
Viti per radici

ZAHNZANGEN

EXTRACTING FORCEPS

DAVIERS

FÓRCEPS DE EXTRACCIÓN

TENAGLIE

EXTRAKTION

EXTRACTION

EXTRACTION

EXTRACCIÓN

ESTRAZIONE



Wurzelheber
 Root Elevators
 Élévateurs à racines
 Elevadores para raíces
 Leve per radici

EXTRAKTION

EXTRACTION

EXTRACTION

EXTRACCIÓN

ESTRAZIONE

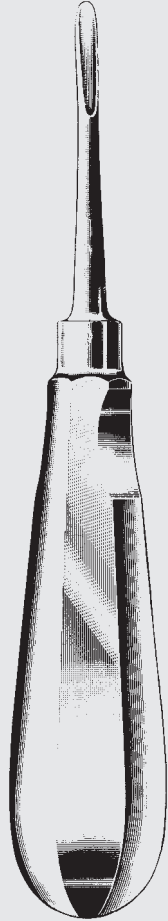

82-0001-05 - 82-0400-00



SELDIN
 82-0001-05
 Fig. 1L



SELDIN
 82-0001-08
 Fig. 1R



SELDIN
 82-0002-00
 Fig. 2



SELDIN
 82-0003-00
 Fig. 3



CRYER
 82-0003-01
 Fig. 3A



SELDIN
 82-0004-05
 Fig. 4L



SELDIN
 82-0004-08
 Fig. 4R



CRANE PICK
 82-0006-00
 Fig. 6



MILLER
 82-0008-00
 Fig. 8



MILLER
 82-0009-00
 Fig. 9



MILLER
 82-0100-00
 Fig. 10



MILLER
 82-0101-00
 Fig. 11



CRYER
 82-0102-00
 Fig. 12



CRYER
 82-0207-00
 Fig. 27



CRYER
 82-0208-00
 Fig. 28



CRYER
 82-0207-01
 Fig. 27S



CRYER
 82-0208-01
 Fig. 28S



SELDIN
 82-0304-00
 Fig. 34



SELDIN
 82-0304-09
 Fig. 34S



CRYER
 82-0309-00
 Fig. 39



CRYER
 82-0400-00
 Fig. 40

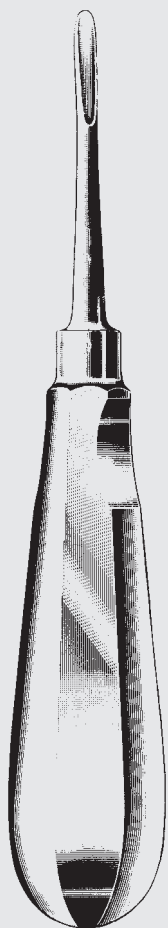

82-0406-00 - 82-3004-00



82-0406-00
Fig. 46

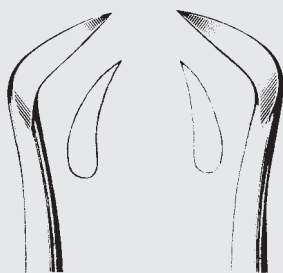

WALTER F. BARRY
82-0500-00 82-0501-00
Fig. 50 Fig. 51



APICAL (Apexo)
82-3001-00
Fig. 301



APICAL
82-3002-00 82-3003-00
Fig. 302 Fig. 303



APICAL
82-3004-00
Fig. 304

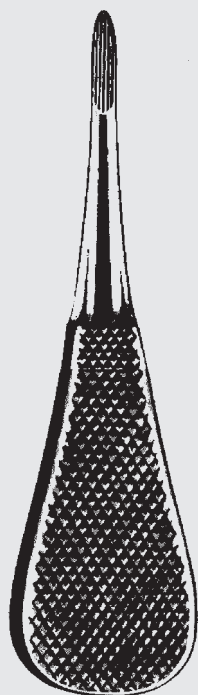

COLEMAN (LONDON HOSPITAL)
82-4005-01 - 82-4005-03



82-4005-01



82-4005-02



82-4005-03



WARWICK JAMES
82-4100-01



WARWICK JAMES
82-4100-02 82-4100-03

Wurzelheber
Root Elevators
Élévateurs à racines
Elevadores para raíces
Leve per radici

EXTRAKTION

EXTRACTION

EXTRACTION

EXTRACCIÓN

ESTRAZIONE



82-4100-03

82.3

Wurzelheber
Root Elevators
Élévateurs à racines
Elevadores para raíces
Leve per radici

EXTRAKTION

EXTRACTION

EXTRACTION

EXTRACCIÓN

ESTRAZIONE

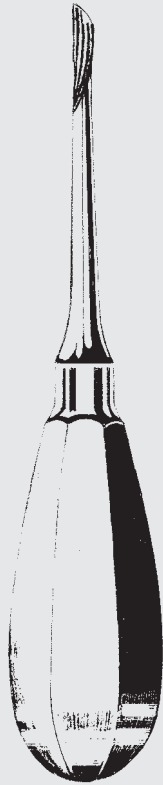

KOPP
82-4104-01 - 82-4104-04



82-4104-01
Fig. 1



82-4104-02
Fig. 2



82-4104-03
Fig. 3



82-4104-04
Fig. 4

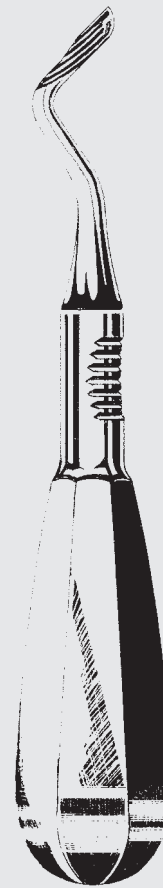

KOPP
82-8105-01 - 82-8105-04



82-8105-01
Fig. 1



82-8105-02
Fig. 2



82-8105-03
Fig. 3



82-8105-04
Fig. 4



FLOHR
82-2001-01 - 82-5001-03



82-5001-01
Fig. 1



82-5001-02
Fig. 2



82-5001-03
Fig. 3

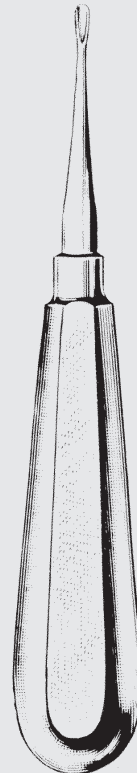

FRIEDMAN
82-5005-01 - 82-5005-03



82-5005-01
Fig. 1



82-5005-02
Fig. 2



82-5005-03
Fig. 3

Wurzelheber
 Root Elevators
 Élévateurs à racines
 Elevadores para raíces
 Leve per radici

EXTRAKTION

EXTRACTION

EXTRACTION

EXTRACCIÓN

ESTRAZIONE

ZEPF[®]
INSTRUMENTS

82-5303-71

82.5

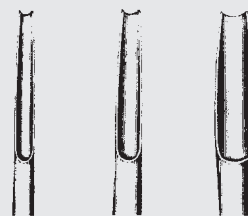

82-5101-00 82-5101-01 82-5101-02
 Fig. 1=2 mm Fig. 2=3 mm Fig. 3=4 mm

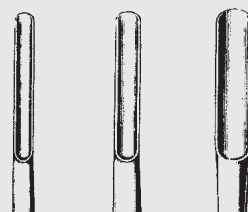

82-5102-00 82-5102-01 82-5102-02
 Fig. 1=2 mm Fig. 2=3 mm Fig. 3=4 mm

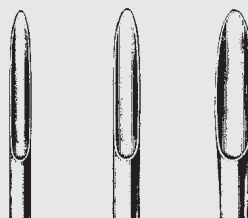

82-5103-00 82-5103-01 82-5103-02
 Fig. 1=2 mm Fig. 2=3 mm Fig. 3=4 mm



82-5303-20 82-5303-21
 Fig. 320 Fig. 321



82-5303-22 82-5303-23
 Fig. 322 Fig. 323



82-5303-70 82-5303-71
 Fig. 370 Fig. 371

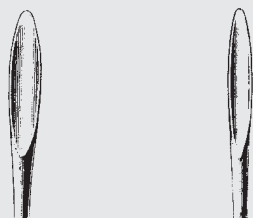

82-5008-01 82-5008-02
 Fig. 1 Fig. 2

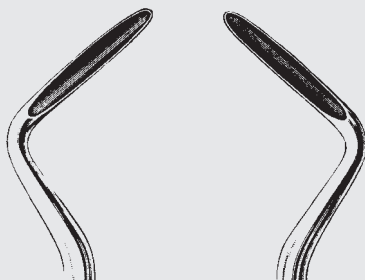

82-5008-03 82-5008-04
 Fig. 3 Fig. 4



BEIN
 82-5101-00 - 82-5103-02



HYLIN
 82-5008-01 - 82-5008-04



82-5202-01 82-5202-02
 Fig. 1 Fig. 2

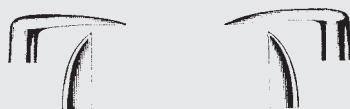

82-5202-05 82-5202-06
 Fig. 5 Fig. 6

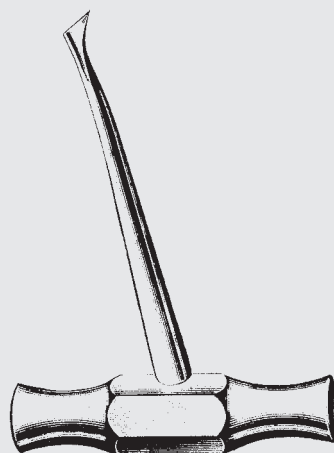

BARRY
 82-5303-20 - 82-5303-71



LOOS
 82-5202-01 - 82-5202-06

Wurzelheber
Root Elevators
Élévateurs à racines
Elevadores para raíces
Leve per radici



COUPLAND
82-5400-20 - 82-5400-30



82-5400-20 82-5400-25 82-5400-30
2,0 mm 2,5 mm 3,0 mm

Meissel - Gouges - Gouges - Gubias - Sgorbie



LECLUSE
82-5550-01 - 82-5550-02



82-5550-01
Fig. 1



82-5550-02
Fig. 2

EXTRAKTION

EXTRACTION

EXTRACTION

EXTRACCIÓN

ESTRAZIONE



82-5500-05 82-5500-08
Fig. 1L Fig. 1R



82-5501-05 82-5501-08
Fig. 11L Fig. 11R



82-5502-05 82-5502-08
Fig. 12L Fig. 12R

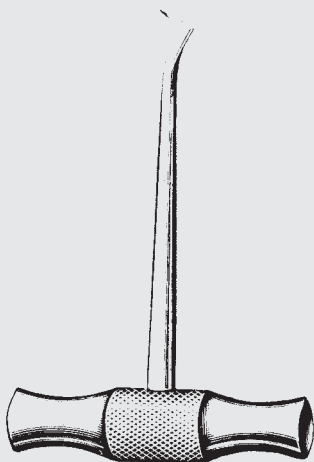

WINTER
82-5500-05 - 82-5504-08



82-5503-05 82-5503-08
Fig. 13L Fig. 13R

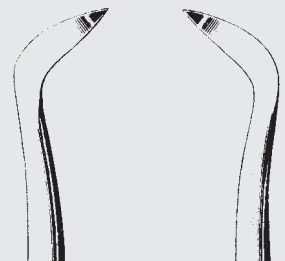

82-5504-05 82-5504-08
Fig. 14L Fig. 14R



82-5400-20

82.6

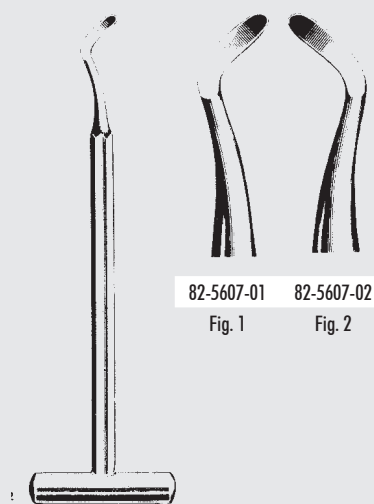

82-5607-01 82-5607-02
Fig. 1 Fig. 2

POTT

82-5607-01 - 82-5607-02

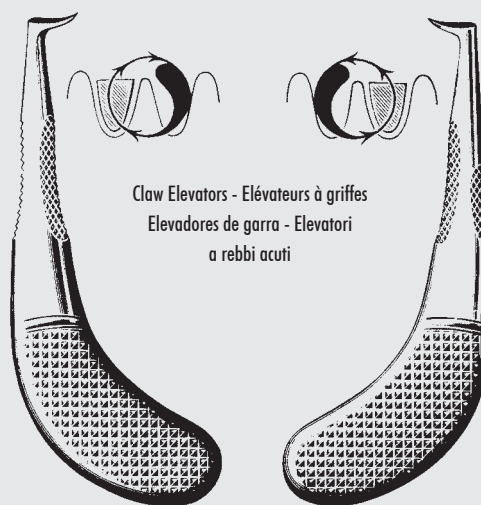

Claw Elevators - Elévateurs à griffes
Elevadores de garra - Elevatori
a rebbi acuti

KRALLENHEBER

82-5701-01 82-5701-02
Fig. 1 Fig. 2

Wurzelheber
Root Elevators
Élévateurs à racines
Elevadores para raíces
Leve per radici

EXTRAKTION

EXTRACTION

EXTRACTION

EXTRACCIÓN

ESTRAZIONE

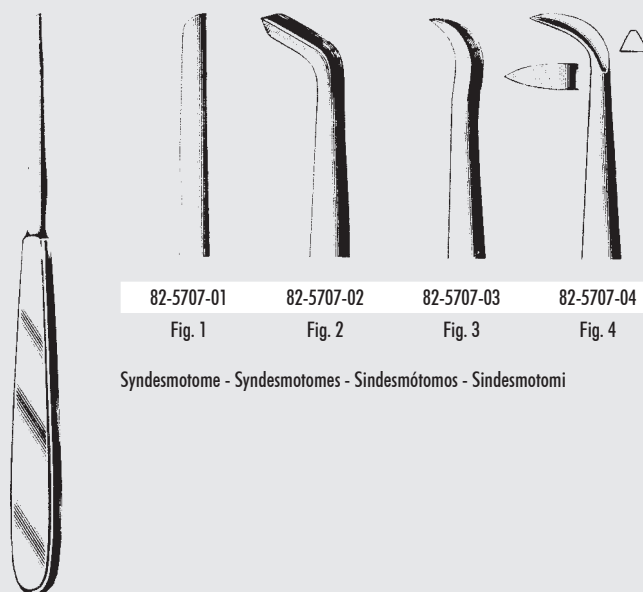

82-5707-01 82-5707-02 82-5707-03 82-5707-04
Fig. 1 Fig. 2 Fig. 3 Fig. 4

Syndesmotome - Syndesmotomes - Sindesmótomos - Sindesmotomi

CHOMPRET

82-5707-01 - 82-5707-04

Wurzelspitzenheber
 Apical Fragment Ejectors
 Elévateurs à fragments
 Elevadores para fragmentos
 Elevatori per frammenti

EXTRAKTION

EXTRACTION

EXTRACTION

EXTRACCIÓN

ESTRAZIONE



HEIDBRINK
 82-5802-01 - 82-5802-03



82-5802-01
 Fig. 1

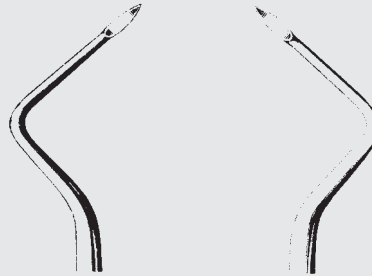

82-5802-02
 Fig. 2

82-5802-03
 Fig. 3



HEIDBRINK
 82-5807-01 - 82-5807-03



82-5807-01
 Fig. 1

82-5807-02
 Fig. 2

82-5807-03
 Fig. 3



RATZOW
82-5805-01 - 82-5805-03



82-5805-01
Fig. 1



82-5805-02 82-5805-03
Fig. 2 Fig. 3

Wurzelspitzenausschäler
Apical Fragment Enucleators
Décortiqueurs à fragments
Descorticadores de fragmentos
Leve per frammenti

EXTRAKTION

EXTRACTION

EXTRACTION

EXTRACCIÓN

ESTRAZIONE

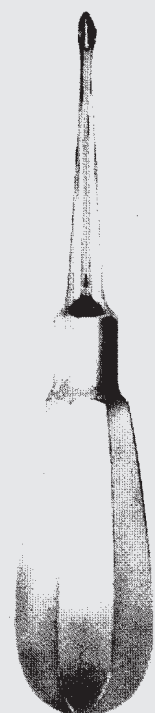

VIGNAL
82-5809-54 - 82-5809-69



82-5809-54
Fig. 54



82-5809-55
Fig. 55



82-5809-56
Fig. 56



82-5809-57
Fig. 57



82-5809-69
Fig. 69

Wurzelheber
Root Elevators
Élévateurs à racines
Elevadores para raíces
Leve per radici



82-5809-69

82.9

SPRITZEN,
MUNDSPIEGEL

SYRINGES,
MOUTH MIRRORS

SERINGUES,
MIROIRS A BOUCHE

JERINGAS,
ESPEJOS BUCALES

SIRINGHE,
SPECCHIETTI

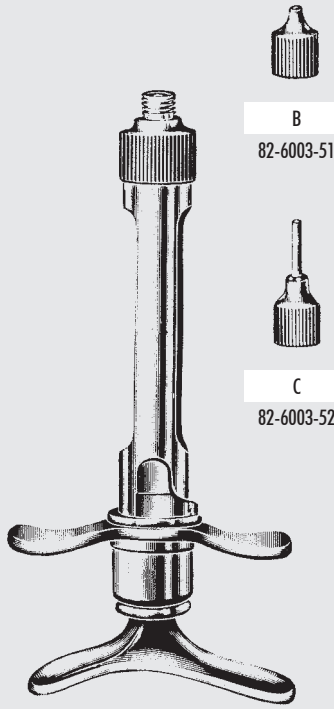

B
82-6003-51

C
82-6003-52

82-6002-18 1,8 cc 82-6004-18
82-6002-22 2,2 c 82-6004-22

mit Aspirationshaken
with aspiration hook
avec crochet d'aspiration
con gancho de aspiración
con gancho da aspirazione



17 x 23



17 x 42

82-6100-23 / 17 x 23 = 12 St. / p.
82-6100-42 / 17 x 42 = 12 St. / p.

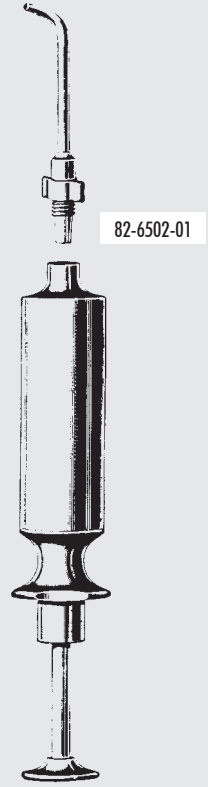

82-6502-01

82-6502-00

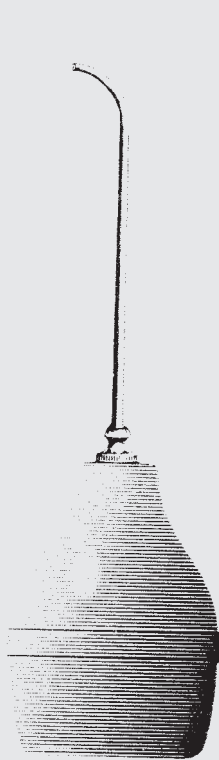

82-6601-00

normal

82-7002-22 Fig. 4 ø 22 mm
82-7002-24 Fig. 5 ø 24 mm
plan · plane · non-grossissant
plano · piano

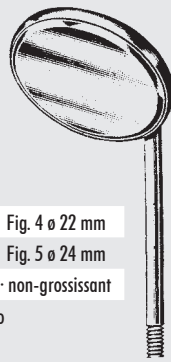

Cone Socket

82-7004-22 Fig. 4 ø 22 mm
82-7004-24 Fig. 5 ø 24 mm
plan · plane · non-grossissant
plano · piano

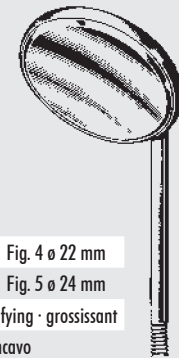

normal

82-7003-22 Fig. 4 ø 22 mm
82-7003-24 Fig. 5 ø 24 mm
hohl · magnifying · grossissant
concavo · concavo

Cone Socket

82-7005-22 Fig. 4 ø 22 mm
82-7005-24 Fig. 5 ø 24 mm
hohl · magnifying · grossissant
concavo · concavo



normal
Cone Socket

82-7201-01
82-7201-02



82-7206-01
82-7206-02



82-7208-01
82-7208-02

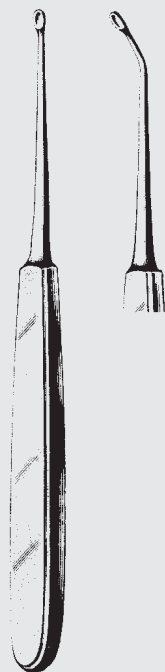

WILLIGER

82-8200-20 - 82-8209-02

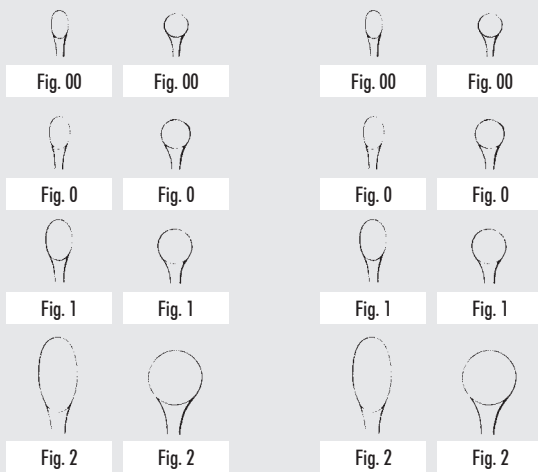

Fig.	—	—	Fig.	—	—
00	82-8200-20	82-8202-20	00	82-8206-20	82-8208-20
0	82-8200-10	82-8202-10	0	82-8206-10	82-8208-10
1	82-8201-01	82-8203-01	1	82-8207-01	82-8209-01
2	82-8201-02	82-8203-02	2	82-8207-02	82-8209-02

Scharfe Löffel
Bone Curettes
Curettes à os
Cucharillas cortantes
Curette taglienti

CHIRURGIE

SURGERY

CHIRURGIE

CHIRUJIA

CHIRURGIA



U.S.A.

82-8404-01 - 82-8407-06

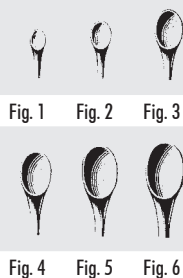

Fig.			
1	82-8404-01	82-8405-01	82-8407-01
2	82-8404-02	82-8405-02	82-8407-02
3	82-8404-03	82-8405-03	82-8407-03
4	82-8404-04	82-8405-04	82-8407-04
5	82-8404-05	82-8405-05	82-8407-05
6	82-8404-06	82-8405-06	82-8407-06



CHOMPRET

82-8501-01 82-8501-02 82-8501-03

Weitere Instrumente für Zahn-, Mund und Kieferchirurgie (Skalpelle, Scheren, Pinzetten, Klemmen, Nadelhalter, Wundhaken und -sperrer usw.) finden Sie in unserem Chirurgie-Hauptkatalog.

For more surgical instruments for oral and maxillo-facial surgery (scalpels, scissors, thumb and tissue forceps, hemostats, needle holders, retractors etc.), please consult our general surgical instruments catalogue.

Pour plus d'instruments pour la chirurgie orale et maxillo-faciale (bistouris, ciseaux, pinces hémostatiques, porte-aiguille, écarteurs etc.), veuillez consulter notre catalogue d'instruments chirurgicaux généraux, svp.



82-8501-03

82.11

Scharfe Löffel
Bone Curettes
Curettes à os
Cucharillas cortantes
Curette taglienti

CHIRURGIE

SURGERY

CHIRURGIE

CIRUJIA

CHIRURGIA

Weitere Instrumente für Zahn-, Mund- und Kieferchirurgie (Skalpelle, Scheren, Pinzetten, Klemmen, Nadelhalter, Wundhaken und -sperrerr usw.) finden Sie in unserem Chirurgie-Hauptkatalog.

Por más instrumentos para la cirugía bucal y maxilo-facial, (bisturíes, tijeras, pinzas de disección, pinzas hemostáticas, porta-aguja, separadores etc.), véase nuestro catálogo general de instrumental quirúrgico.

Per altri strumenti per la chirurgia buccale e mascello-facciale (bisturi, forbici, pinze da dissezione, pinze emostatiche, part'aghi, divaricatori ecc.), vedere il nostro catalogo generale di strumenti chirurgici.

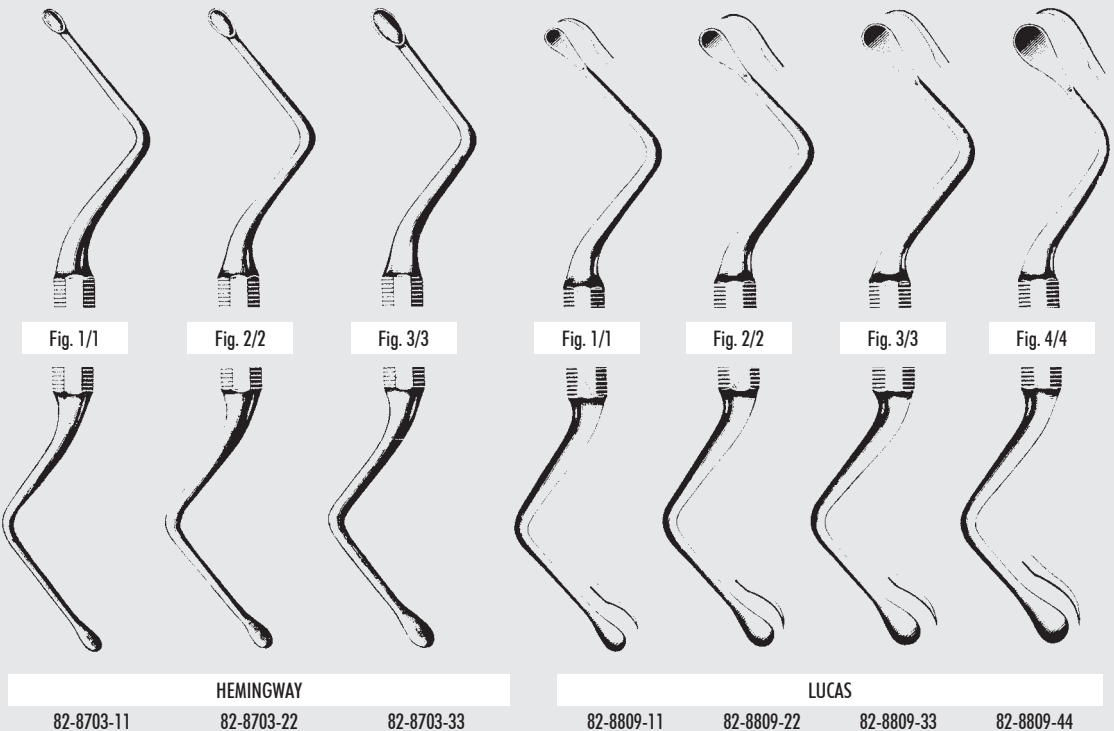
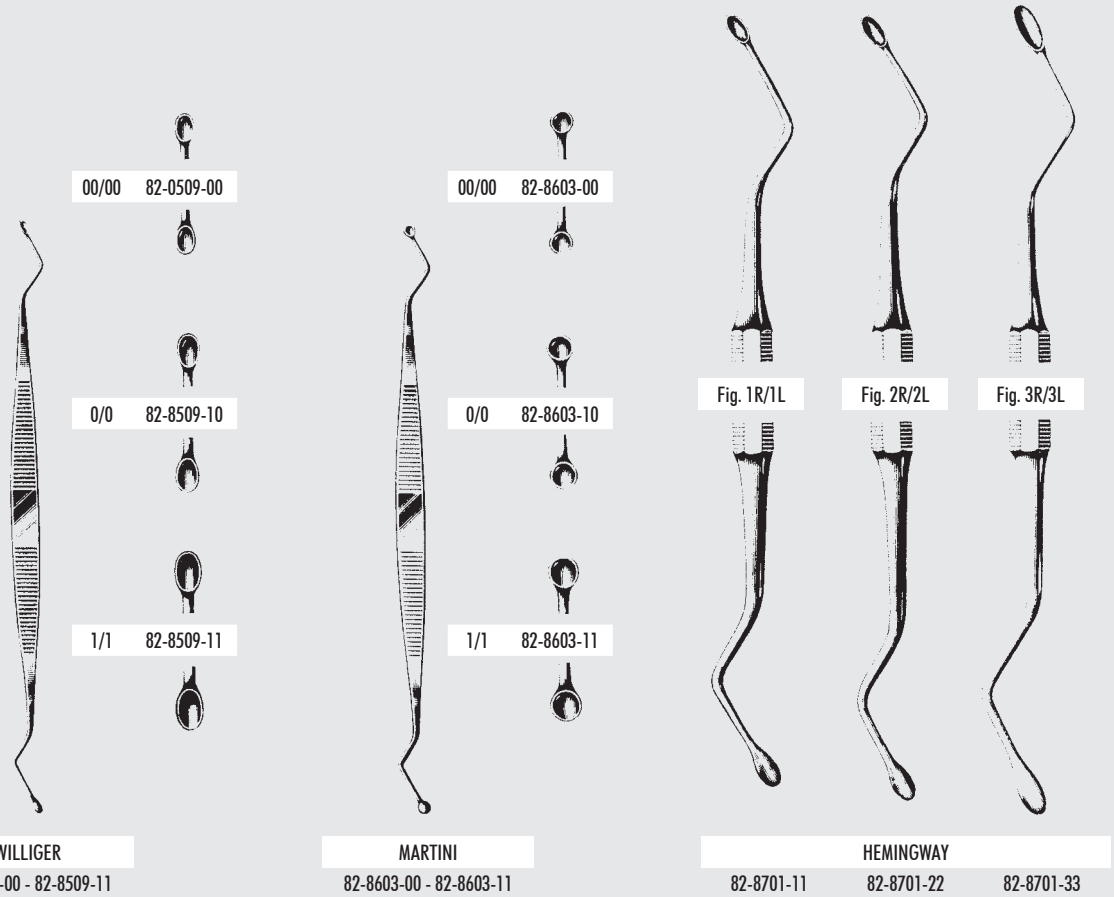

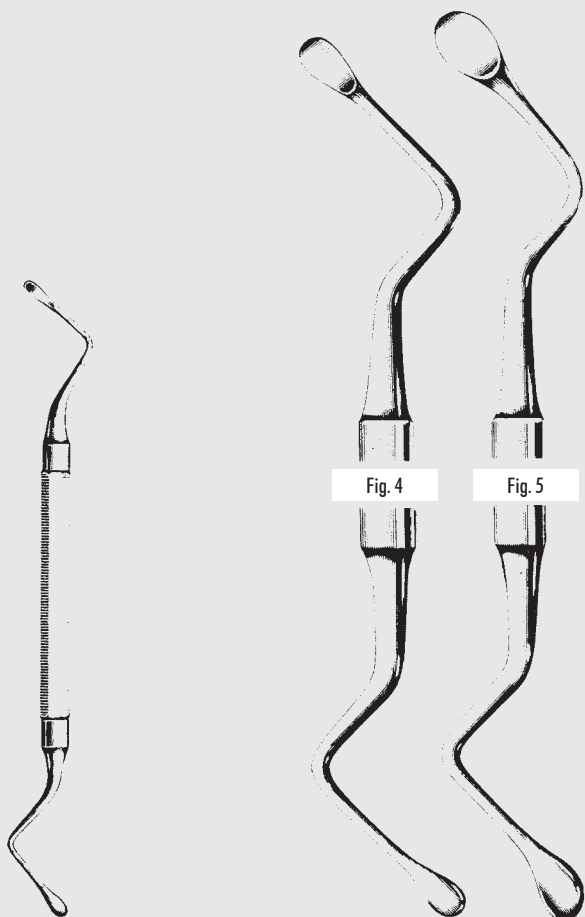

Fig. 4 Fig. 5

MEAD

82-8900-04 82-8900-05

Scharfe Löffel
Bone Curettes
Curettes à os
Cucharillas cortantes
Curette taglianti

CHIRURGIE

SURGERY

CHIRURGIE

CIRUJIA

CHIRURGIA

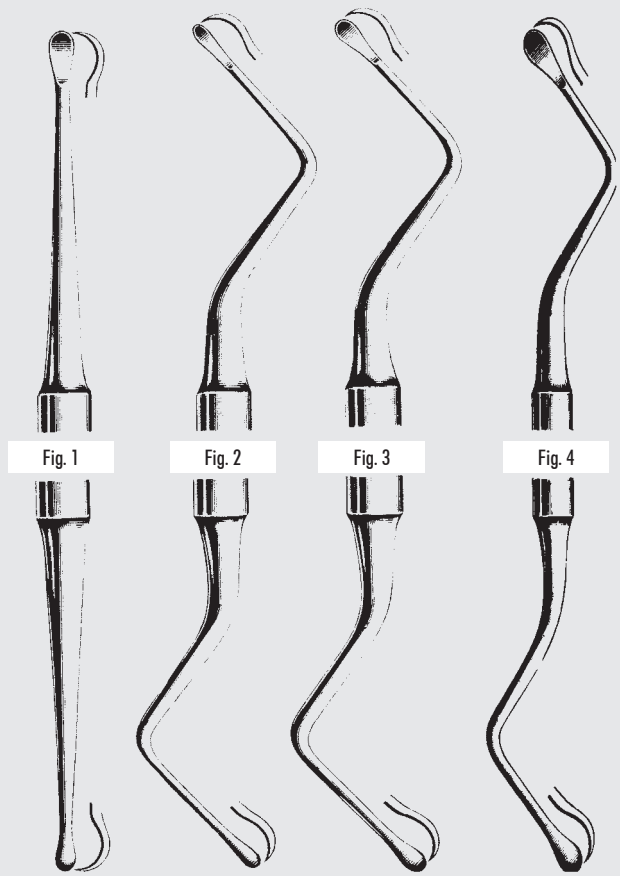

Fig. 1 Fig. 2 Fig. 3 Fig. 4

MILLER COLBURN

82-8903-01 82-8903-02 82-8903-03 82-8903-04

Scharfe Löffel
Bone Curettes
Curettes à os
Cucharillas cortantes
Curette taglianti

Knochenfeilen
Bone Files
Limes à os
Limas para huesos
Lime per ossa

CHIRURGIE

SURGERY

CHIRURGIE

CIRUJIA

CHIRURGIA



Fig. 1



Fig. 2



Fig. 3



Fig. 4



Fig. 5



MILLER COLBURN

82-8905-01

82-8905-02

82-8905-03

82-8905-04

82-8905-05



Fig. 1



Fig. 2



Fig. 3



Fig. 4



Fig. 5



MILLER COLBURN

82-8906-01

82-8906-02

82-8906-03

82-8906-04

82-8906-05

ZEPF®
INSTRUMENTS

82-8905-01

82.14



WILLIGER
82-8907-13



WILLIGER
82-8908-17



WILLIGER
82-8909-16

Knochenfeilen, Raspatorien, Elevatorien
Bone Files, Priosteal Elevators
Limes à os, rugines-raspatoires, éleveurs
Limas para huesos, periostótomos, legras, elevadores
Lime per ossa, periostotomi, elevatori

CHIRURGIE

SURGERY

CHIRURGIE

CIRUJIA

CHIRURGIA



SELDIN
82-9005-22



SELDIN
82-9005-23



SELDIN
82-9006-11



SELDIN
82-9006-12

ZEPF[®]
α
INSTRUMENTS

82-9006-12

82.15

Knochenfeilen, Raspatorien, Elevatorien
 Bone Files, Priosteal Elevators
 Limes à os, rugines-raspatoires, éleveurs
 Limas para huesos, periostótomos, legras, elevadores
 Lime per ossa, periostotomi, elevatori

CHIRURGIE

SURGERY

CHIRURGIE

CIRUJIA

CHIRURGIA



MOLT

82-9100-09

Nr. 9



MEAD

82-9110-03

Nr. 3

DIAGNOSTIK · PARODONTOLOGIE · KONSERVIERENDE ZAHNBEHANDLUNG · ENDODONTIE

DIAGNOSTICS · PARODONTOLOGY · CONSERVATION OF TEETH · ENDODONTIC INSTRUMENTS

DIAGNOSTIC · PARODONTOLOGIE · DENTISTERIE CONSERVATRICE · INSTRUMENTS ENDODONTIQUES

DIAGNÓSTICO · PARADONTOLOGÍA · ODONTOLOGÍA CONSERVADORA · INSTRUMENTOS ENDODÓNTICOS

DIAGNOSTICA · PARADONTOLOGIA · ODONTOLOGIA CONSERVATIVA · STRUMENTI ENDODONTICI

Zahnpinzetten
 Cotton and Dressing Pliers
 Pincettes pour coton
 Pinzas para algodón y curaciones
 Pinzette per medicazione

DIAGNOSTIK

DIAGNOSTICS

DIAGNOSTIC

DIAGNÓSTICO

DIAGNOSTICA

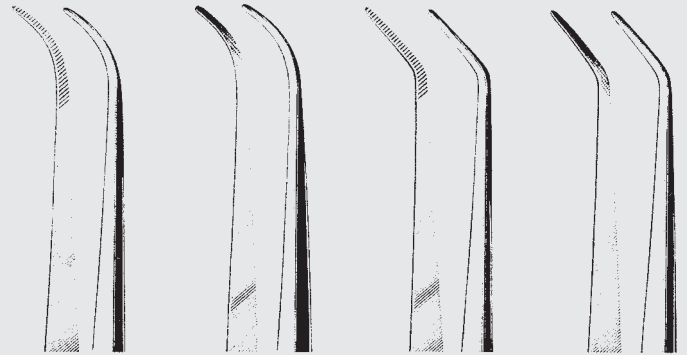

Fig. 1

Fig. 2

Fig. 3

Fig. 4

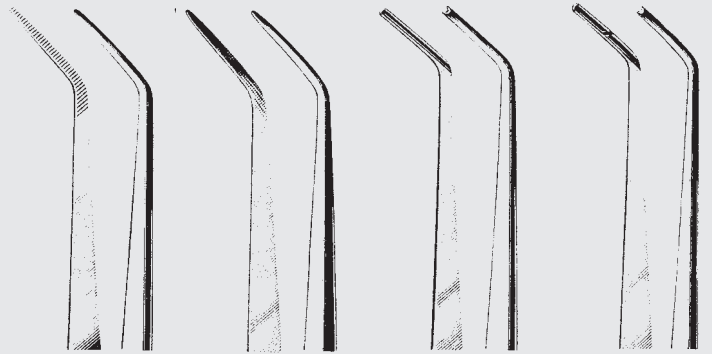
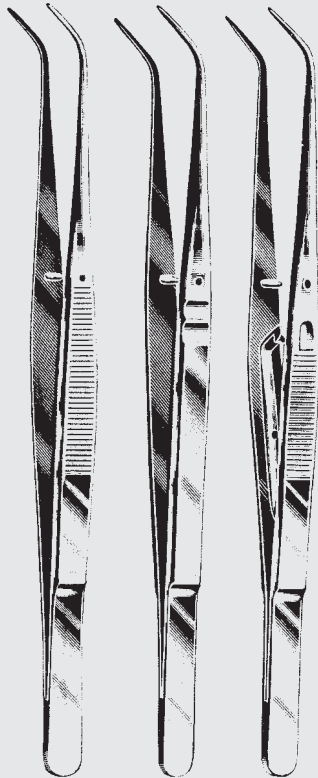

Fig. 5

Fig. 6

Fig. 7

Fig. 8

Fig.	LONDON COLLEGE		
1	83-0301-01	83-0303-01	83-0307-01
2	83-0301-02	83-0303-02	83-0307-02
3	83-0301-03	83-0303-03	83-0307-03
4	83-0301-04	83-0303-04	83-0307-04
5	83-0301-05	83-0303-05	83-0307-05
6	83-0301-06	83-0303-06	83-0307-06
7	83-0301-07	83-0303-07	83-0307-07
8	83-0301-08	83-0303-08	83-0307-08
	15,0 cm	15,0 cm	15,0 cm



83-0301-01

83.2

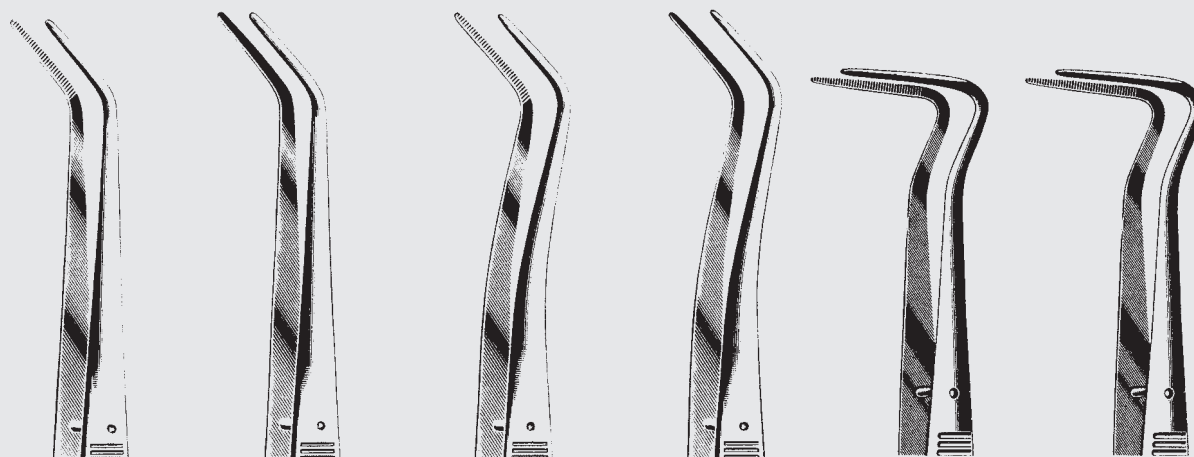

Fig. 1

Fig. 2

Fig. 3

Fig. 4

Fig. 5

Fig. 6

Zahnpinzetten
 Cotton and Dressing Pliers
 Précelles pour coton
 Pinzas para algodón y curaciones
 Pinzette per medicazione

DIAGNOSTIK

DIAGNOSTICS

DIAGNOSTIC

DIAGNÓSTICO

DIAGNOSTICA

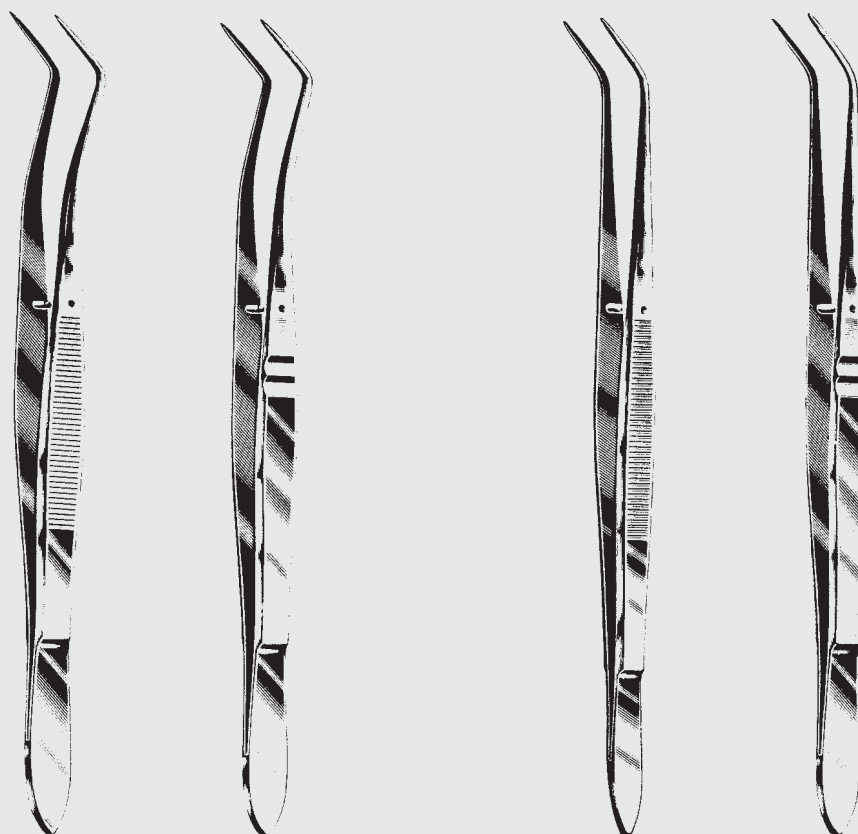

Fig.	MERIAM	
1	83-1001-01	83-1003-01
2	83-1001-02	83-1003-02
3	83-1001-03	83-1003-03
4	83-1001-04	83-1003-04
5	83-1001-05	83-1003-05
6	83-1001-06	83-1003-06
	16,0 cm	16,0 cm

Fig.	FLAGG	
1	83-1007-01	83-1009-01
2	83-1007-02	83-1009-02
3	83-1007-03	83-1009-03
4	83-1007-04	83-1009-04
	16,0 cm	16,0 cm

ZEPF[®]

 INSTRUMENTS

83-1009-04

83.3

Zahnpinzetten
 Cotton and Dressing Pliers
 Prêcelles pour coton
 Pinzas para algodón y curaciones
 Pinzette per medicazione

DIAGNOSTIK

DIAGNOSTICS

DIAGNOSTIC

DIAGNÓSTICO

DIAGNOSTICA



83-1105-03

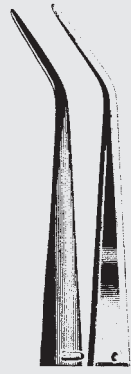

83-1105-04

LANDGRAF
 83-1105-03 - 83-1105-04
 15,0 cm



PERRY
 83-1200-12 83-1201-12
 12,5 cm 12,5 cm

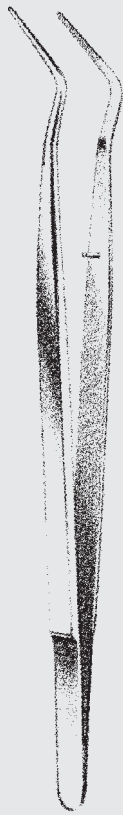

MERIAM, 16,0 cm
 83-1301-03 83-1301-19
 USA Fig. 3 USA Fig. 19



LONDON COLLEGE modif.
 83-1401-15
 15,0 cm

Zahnreiniger
 Scalers
 Détartreurs
 Limpiadores de sarro
 Strumenti per detartraggio



83-2300-01 - 83-2308-00



83-2300-01

WILLIGER



83-2300-02



83-2301-01

WILLIGER



83-2301-02



83-2302-00

FEHR



83-2303-01

CUSHING



83-2303-02



83-2304-00

MUEHLEMANN

83-2305-00

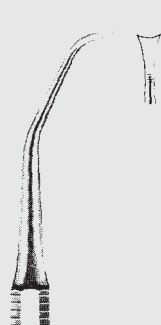

83-2307-00

BLACK



83-2308-00

SENNS

PARODONTOLOGIE

PARADONTOLOGY

PARODONTOLOGIE

PARADONTOLOGÍA

PARADONTOLOGIA



83-2308-00

83.5

Zahnreiniger
Scalers
Détartreurs
Limpiadores de sarro
Strumenti per detartraggio

PARODONTOLOGIE

PARADONTOLOGY

PARADONTOLOGIE

PARADONTOLOGÍA

PARADONTOLOGIA



83-2309-01 - 83-2403-02

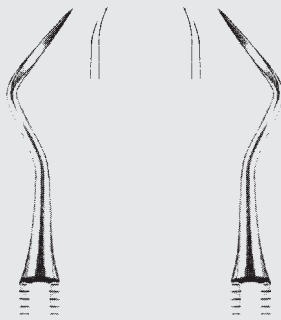

MUEHLEMANN
83-2309-01 83-2309-02

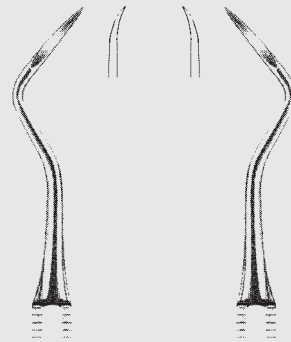

MUEHLEMANN
83-2400-01 83-2400-02



83-2401-01
Fig. 2L



83-2401-02
Fig. 2R



83-2402-01
Fig. 4L



83-2402-02
Fig. 4R

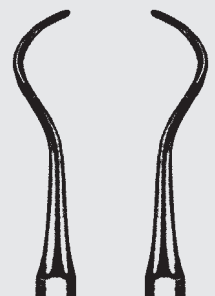

MUEHLEMANN
83-2403-01 83-2403-02
Fig. 2L Fig. 2R



83-2309-01

83.6

Zahnreiniger
 Scalers
 Détartreurs
 Limpiadores de sarro
 Strumenti per detartraggio



83-2405-01
 Fig. 1



83-2405-02
 Fig. 2



83-2405-03
 Fig. 3



83-2405-04
 Fig. 4



83-2405-05
 Fig. 5



83-2405-06
 Fig. 6



83-2405-32
 Fig. 32



83-2405-33
 Fig. 33



83-2405-34
 Fig. 34



83-2405-35
 Fig. 33½



83-2405-36
 Fig. 34½



83-2405-37
 Fig. 33A



83-2405-38
 Fig. 34A



83-2405-01 - 83-2405-38

PARODONTOLOGIE

PARODONTOLOGY

PARODONTOLOGIE

PARADONTOLOGÍA

PARADONTOLOGIA



83-2405-38

83.7

Zahnreiniger
Scalers
Détartreurs
Limpiadores de sarro
Strumenti per detartraggio

PARODONTOLOGIE

PARADONTOLOGY

PARODONTOLOGIE

PARADONTOLOGÍA

PARADONTOLOGIA

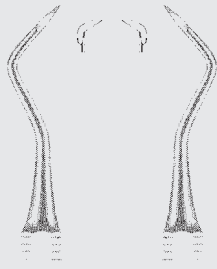

83-2500-02

83-2500-03



83-2500-04



83-2500-05

83-2500-06

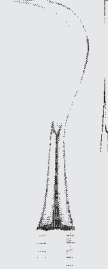

83-2500-07

83-2500-08

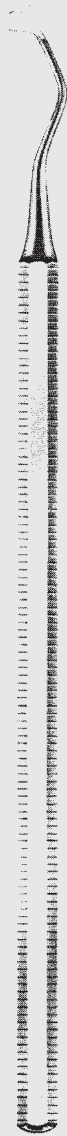

83-2500-01

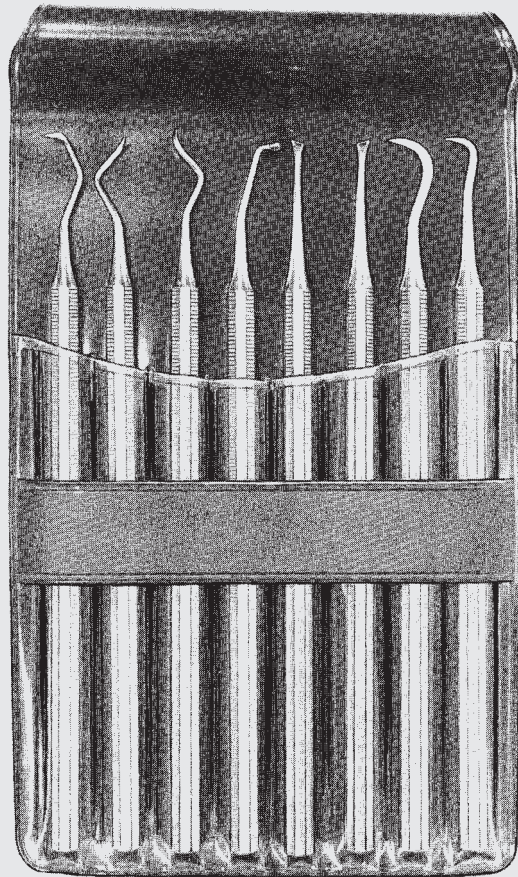

83-2500-00

SET = 8

ZEPF[®]
α
INSTRUMENTS

83-2500-00

83.8

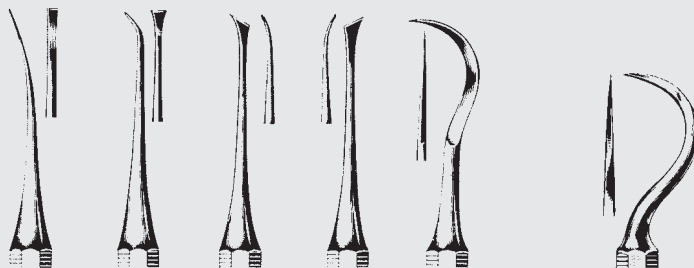

DARBY PERRY				
83-2501-01	83-2501-04	83-2501-05	83-2501-06	83-2501-11
Fig. 1	Fig. 4	Fig. 5	Fig. 6	Fig. 11

CLEVELAND
83-2505-15
Fig. 15

Zahnreiniger
Scalers
Détartreurs
Limpiadores de sarro
Strumenti per detartraggio

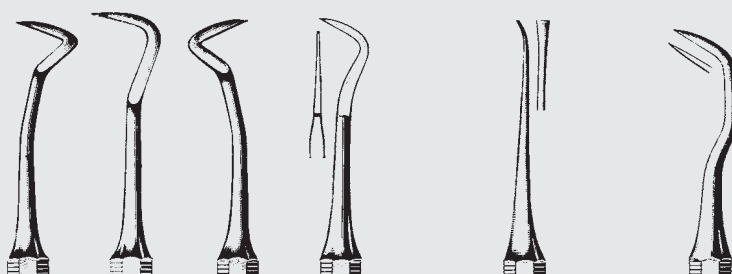

WHITE			
83-2601-01	83-2601-02	83-2601-03	83-2601-12
Fig. 1	Fig. 2	Fig. 3	Fig. 12B

ZERFING
83-2605-13

WHITTEN
83-2607-01
Fig. 1

PARODONTOLOGIE

PARODONTOLOGY

PARODONTOLOGIE

PARADONTOLOGÍA

PARADONTOLOGIA

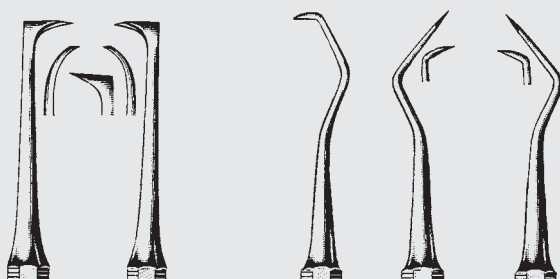

MOORE	
83-2609-01	83-2609-02
Fig. 1	Fig. 2

JACQUETTE		
83-2701-01	83-2701-02	83-2701-03
Fig. J1	Fig. J2	Fig. J3

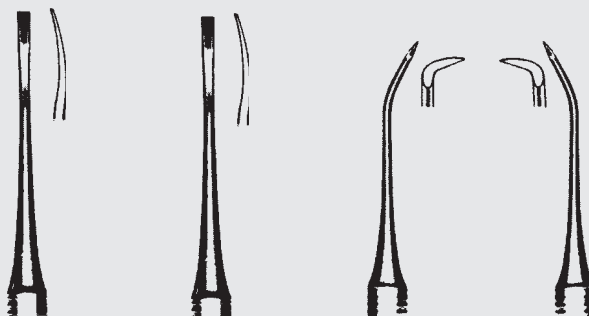

GUY			
83-2703-01	83-2703-02	83-2703-03	83-2703-04
Fig. 1	Fig. 2	Fig. 3	Fig. 4

83-2501-01 - 83-2703-04



83-2703-04

83.9

Zahnreiniger
 Scalers
 Détartreurs
 Limpiadores de sarro
 Strumenti per detartraggio

PARODONTOLOGIE

PARODONTOLOGY

PARODONTOLOGIE

PARADONTOLOGÍA

PARADONTOLOGIA

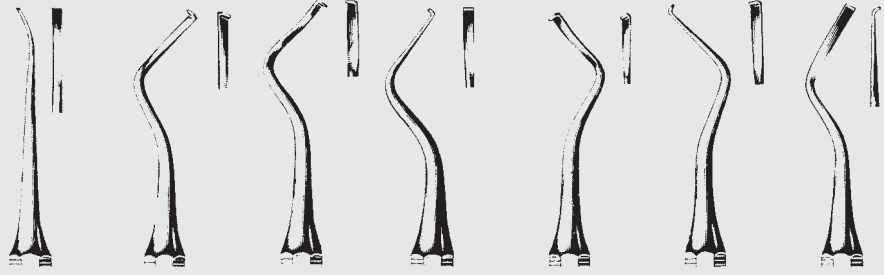

83-2707-01 Fig. 1 83-2707-02 Fig. 2 83-2707-03 Fig. 3 83-2707-04 Fig. 4 83-2707-05 Fig. 5 83-2707-06 Fig. 6 83-2707-07 Fig. 7

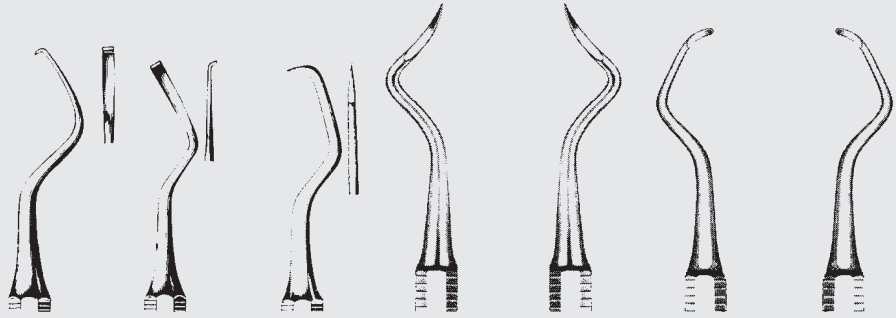

83-2707-08 Fig. 8 83-2707-09 Fig. 9 83-2707-10 Fig. 10 83-2707-11 Fig. 11A 83-2707-12 Fig. 12A 83-2707-13 Fig. 13 83-2707-14 Fig. 14

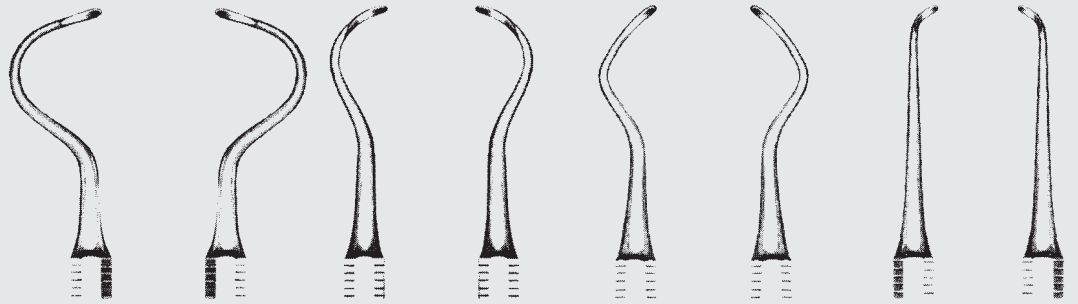

83-2707-15 Fig. 15 83-2707-16 Fig. 16 83-2707-17 Fig. 17 83-2707-18 Fig. 18 83-2707-19 Fig. 19 83-2707-20 Fig. 20 83-2707-21 Fig. 21 83-2707-22 Fig. 22

McCALL

83-2707-01 - 83-2707-31

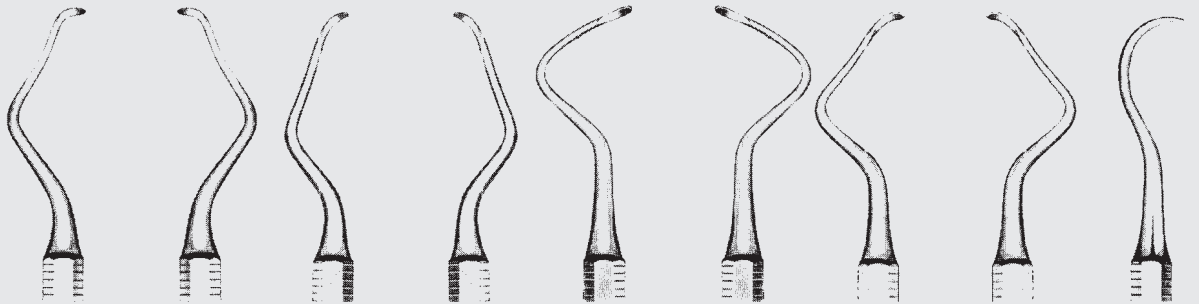

83-2707-23 Fig. 23 83-2707-24 Fig. 24 83-2707-25 Fig. 25 83-2707-26 Fig. 26 83-2707-27 Fig. 27 83-2707-28 Fig. 28 83-2707-29 Fig. 29 83-2707-30 Fig. 30 83-2707-31 Fig. 10A

ZEPF[®]

 INSTRUMENTS

83-2707-01

83.10



ABOTT
83-2709-01 - 83-2709-04

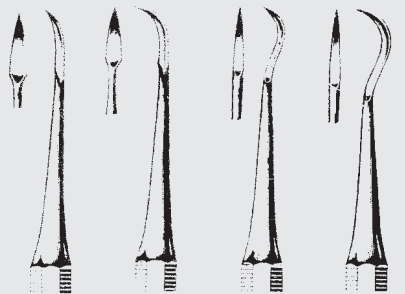

83-2709-01 Fig. 1 83-2709-02 Fig. 2 83-2907-03 Fig. 3 83-2907-04 Fig. 4



GUENTHER
83-2805-02



SHEPHERD
83-2807-00



83-2808-34
Fig. 43/44



GLOBE
83-2801-00



CUMINE
83-2802-02



MITCHELL
83-2803-02

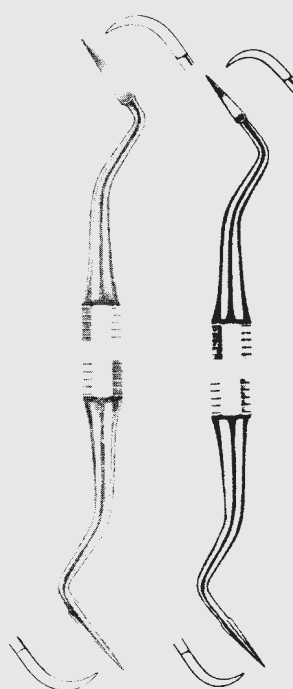

83-2809-01

83-2809-02

Zahnreiniger
Scalers
Détartreurs
Limpiadores de sarro
Strumenti per detartraggio

PARODONTOLOGIE

PARODONTOLOGY

PARODONTOLOGIE

PARADONTOLOGÍA

PARADONTOLOGIA

ZEPF
α
INSTRUMENTS

83-2809-02

83.11



Zahnreiniger
 Scalers
 Déartreurs
 Limpiadores de sarro
 Strumenti per detartraggio

PARODONTOLOGIE

PARODONTOLOGY

PARODONTOLOGIE

PARADONTOLOGÍA

PARADONTOLOGIA

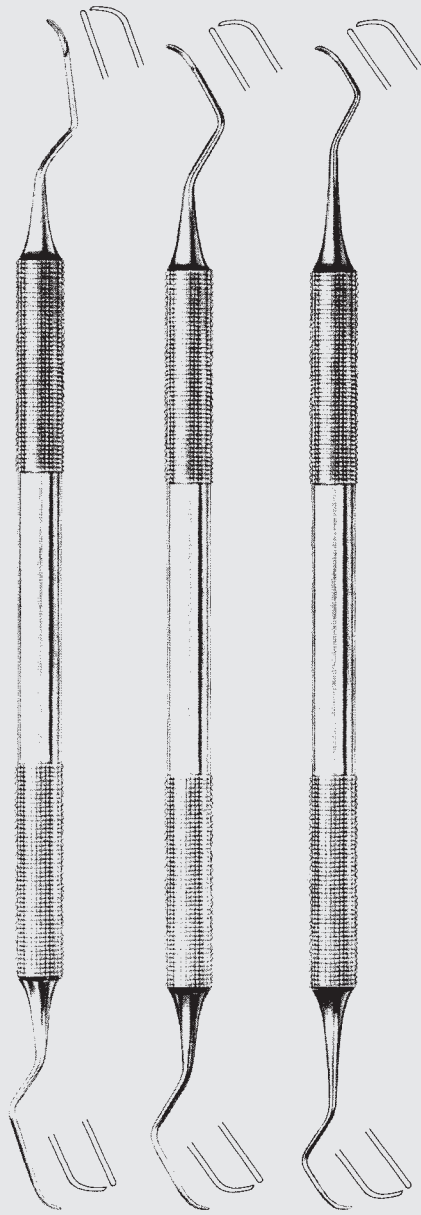

COLUMBIA 83-2900-02 Fig. 2R/2L	COLUMBIA 83-2900-04 Fig. 4R/4L	COLUMBIA 83-2900-14 Fig. 13/14
--------------------------------------	--------------------------------------	--------------------------------------

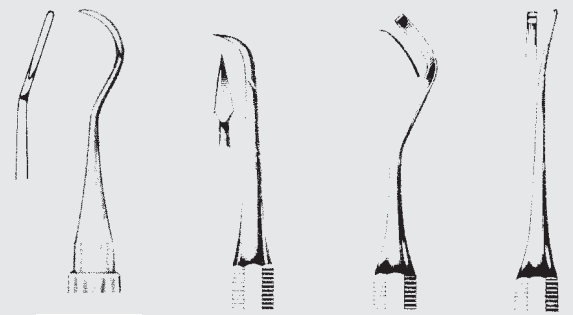
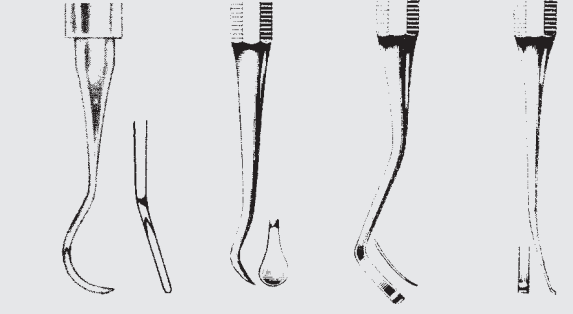

Fig. 7/8	Fig. 213	Fig. 229	Fig. 230
----------	----------	----------	----------



YOUNGER GOOD 83-2901-08	FEHR 83-2902-13	83-2902-29	83-2902-30
----------------------------	--------------------	------------	------------

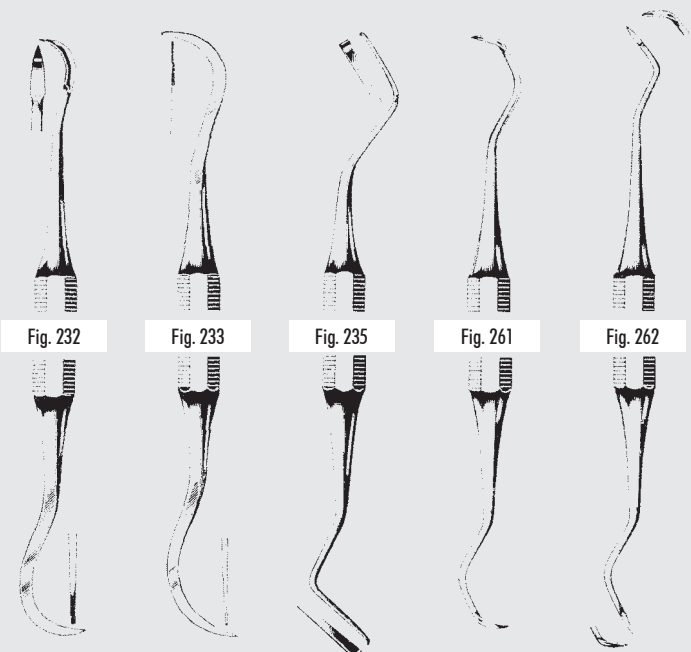
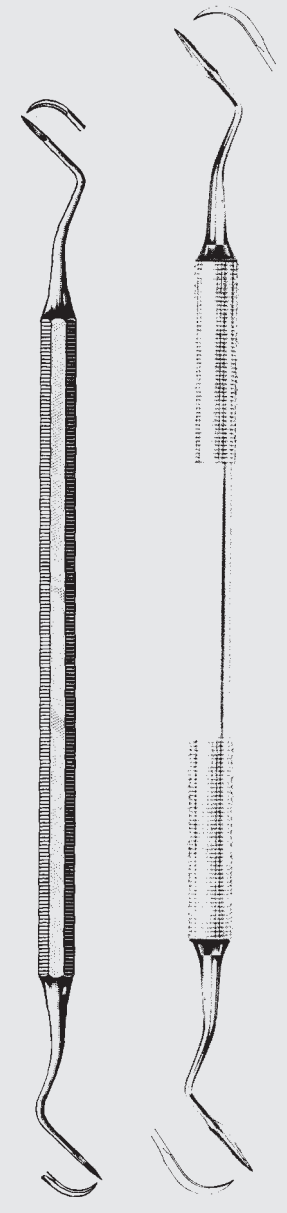

Fig. 232	Fig. 233	Fig. 235	Fig. 261	Fig. 262
83-2902-32	83-2902-33	83-2902-35	JACQUETTE 83-2902-61	JACQUETTE 83-2902-62



TAYLOR 83-2903-01 Fig. ST2/3	83-2903-02 Fig. SCI2/3
------------------------------------	---------------------------



83-2900-02

83.12

Zahnreiniger
 Scalers
 Détartreurs
 Limpiadores de sarro
 Strumenti per detartraggio

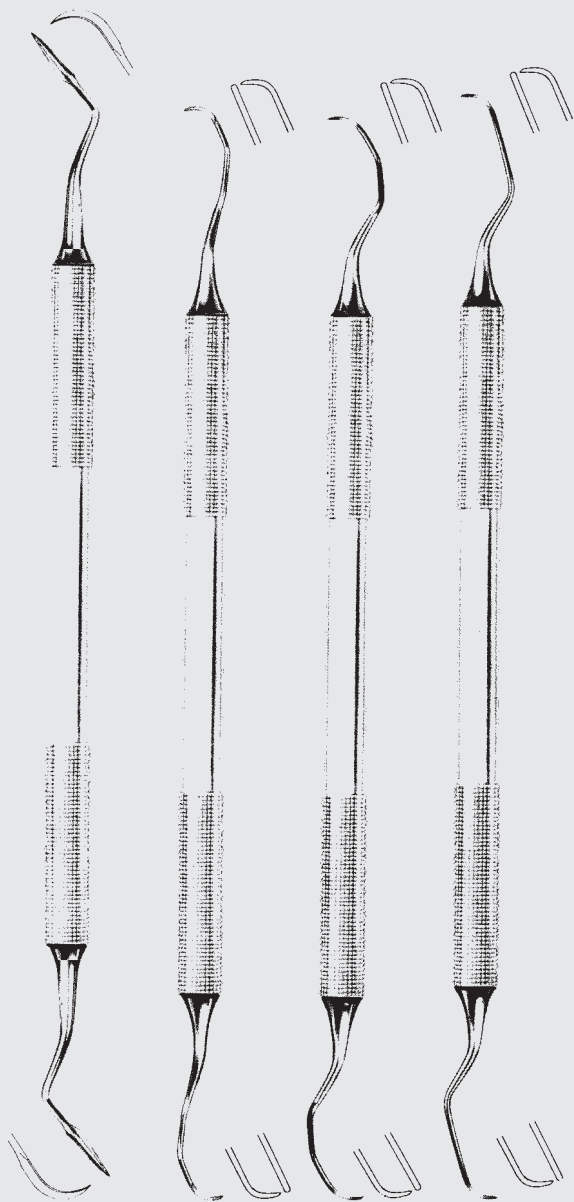

CRANE KAPLAN

83-2903-06

Fig. CK6

LANGER

83-2905-02

Fig. 1/2

83-2905-04

Fig. 3/4

83-2905-06

Fig. 5/6

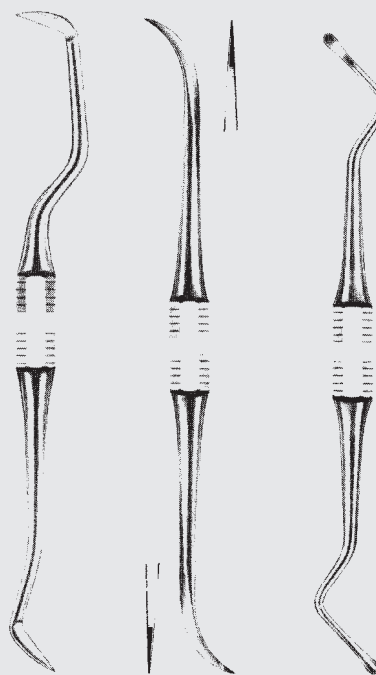

HAUBEIL

83-2906-01

83-2906-02

83-2906-03

PARODONTOLOGIE

PARODONTOLOGY

PARODONTOLOGIE

PARADONTOLOGÍA

PARADONTOLOGIA

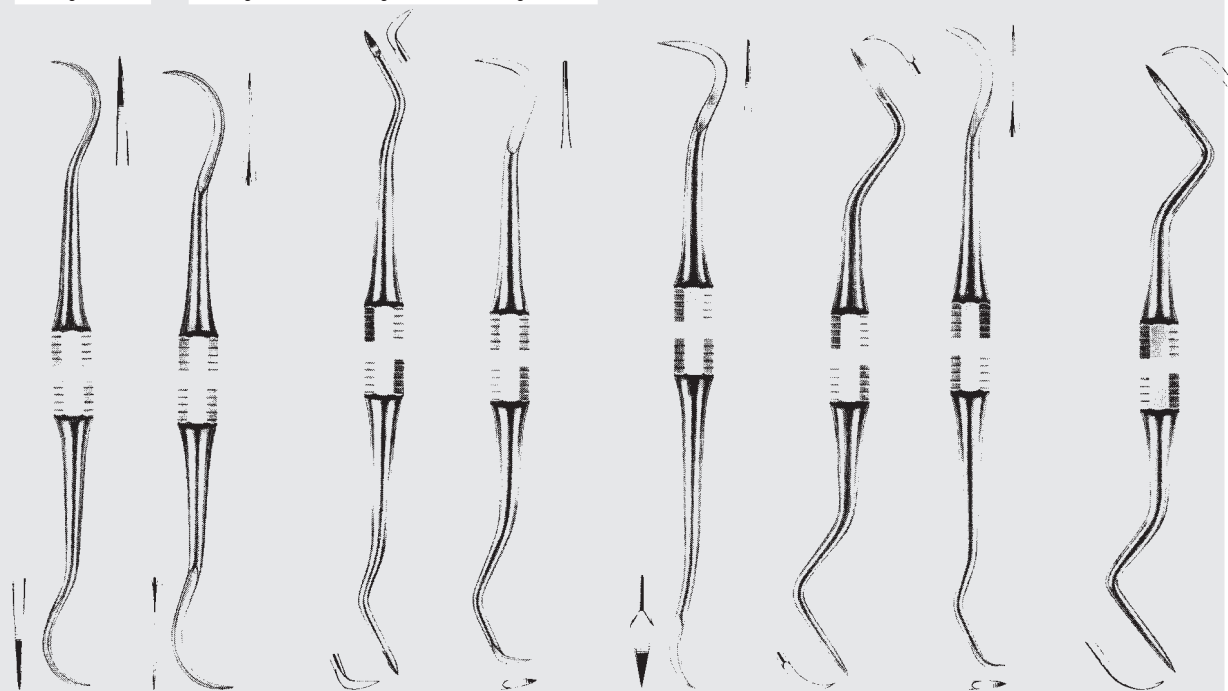

YOUNGER GOOD

83-2906-04

83-2906-05

BAYLOR

83-2906-06

83-2906-07

83-2906-08

MUEHLEMANN

83-2906-09

83-2906-10

REMINGTON

83-2907-12

ZEPF[®]
 INSTRUMENTS

83-2907-12

83.13

Zahnreiniger
 Scalers
 Déartreurs
 Limpiadores de sarro
 Strumenti per detaraggio

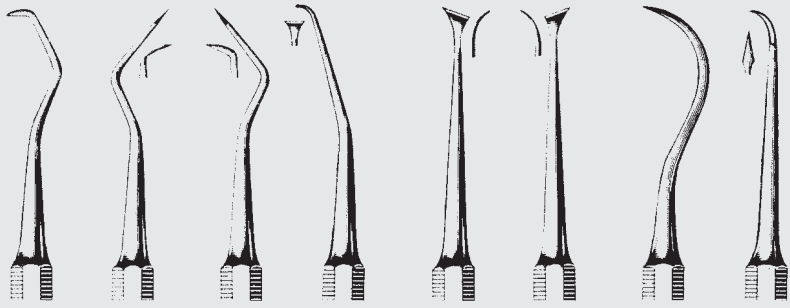

SCHARMANN							
83-3001-01	83-3001-02	83-3001-03	83-3001-04	83-3001-05	83-3001-06	83-3001-07	83-3001-08
Fig. 1	Fig. 2	Fig. 3	Fig. 4	Fig. 5	Fig. 6	Fig. 7	Fig. 8

PARADONTOLOGIE

PARADONTOLOGY

PARADONTOLOGIE

PARADONTOLOGÍA

PARADONTOLOGIA

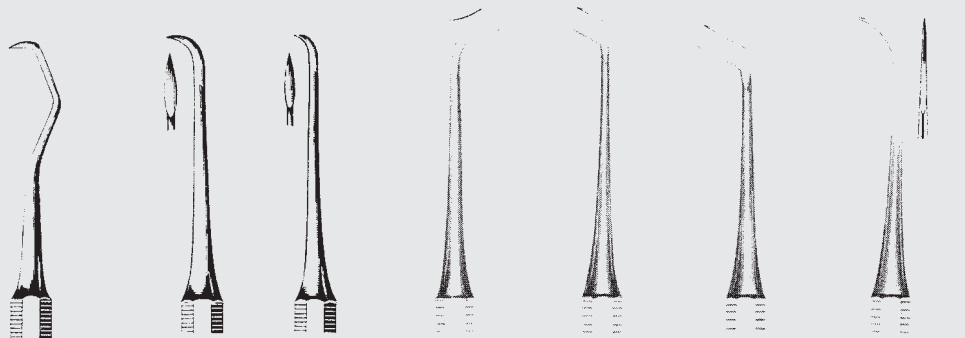

WHITESIDE		SMITH	THORPE I	THORPE II	CALIFORNIA
83-3003-01	83-3003-02	83-3006-00	83-3006-01	83-3006-02	83-3007-14
Fig. 1	Fig. 2				

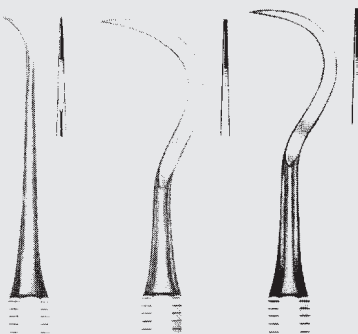

YOUNGER 15	SICHEL 23	TOWNER U15
83-3007-15	83-3007-23	83-3008-15

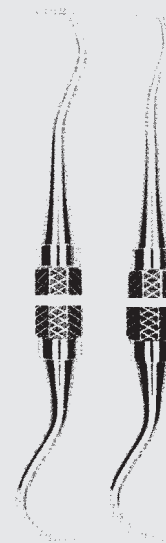

TOWNER JACQUETTE	
83-3008-30	83-8008-33
U15/30	U15/33

83-3001-01 - 83-3008-15

ZEPF[®]
α
 INSTRUMENTS

83-3001-01

83.14

Zahnreiniger
Scalers
Détartreurs
Limpiadores de sarro
Strumenti per detartraggio

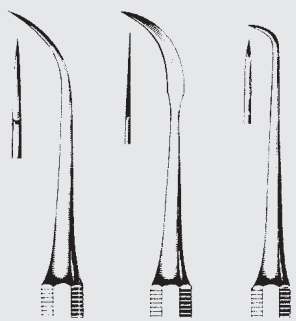

YOUNGER GOOD
83-3100-13 83-3100-14 83-3100-15
Fig. 13 Fig. 14 Fig. 15

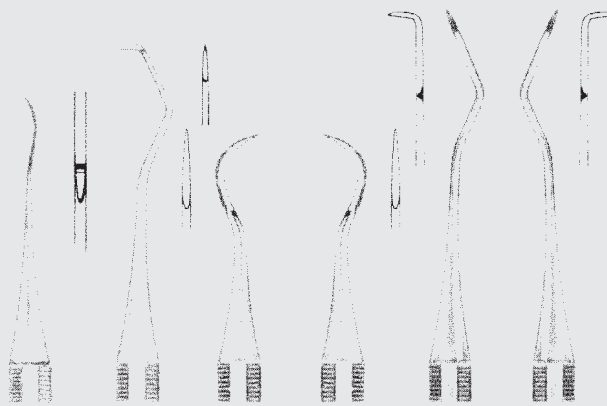

HYGIENIST
83-3101-04 83-3101-05 83-3101-06 83-3101-07 83-3101-08 83-3101-09
Fig. H4 Fig. H5 Fig. H6 Fig. H7 Fig. H8 Fig. H9

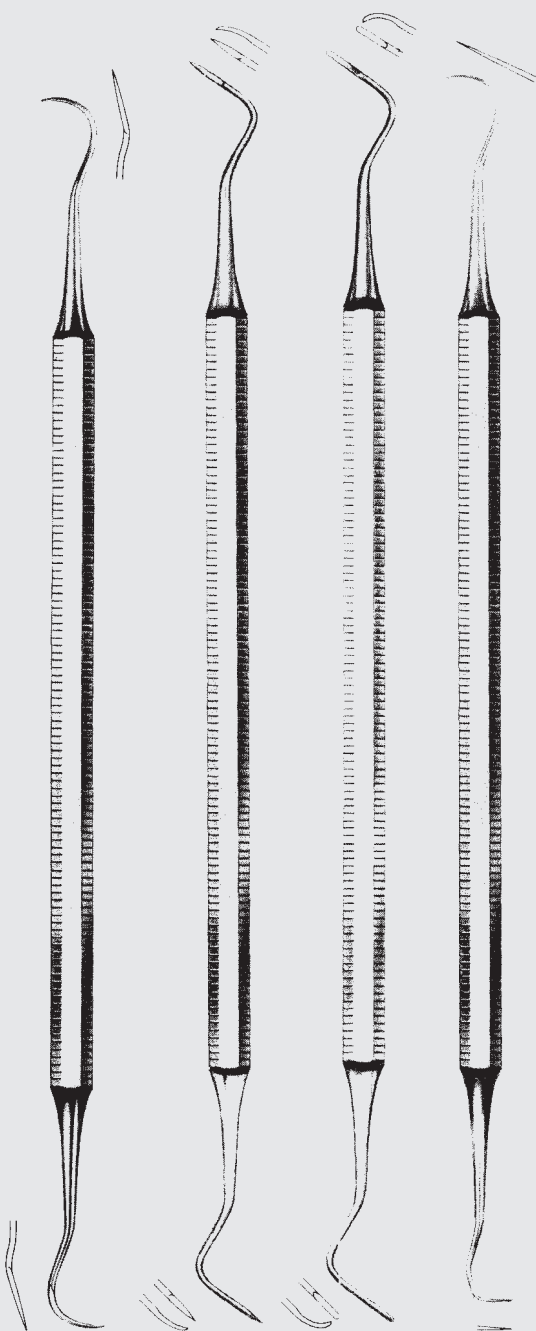

HYGIENIST 83-3102-07 Fig. H6/H7
McCALL 83-3102-13 Fig. 13S/14S
McCALL 83-3102-14 Fig. 13/14
HYGIENIST 83-3102-33 Fig. H5/33

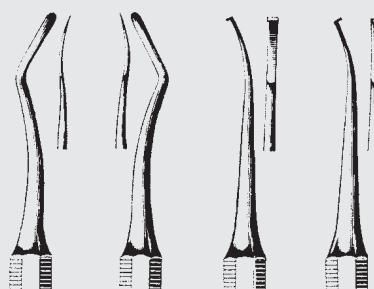

BLACK
83-3103-01 83-3103-02 83-3103-03 83-3103-04
Fig. 1 Fig. 2 Fig. 3 Fig. 4

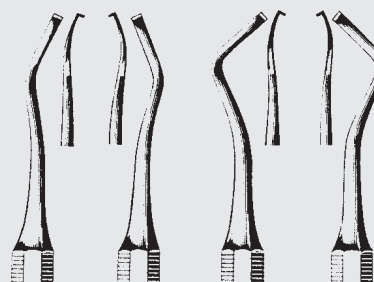

BLACK
83-3103-05 83-3103-06 83-3103-07 83-3103-08
Fig. 5 Fig. 6 Fig. 7 Fig. 8

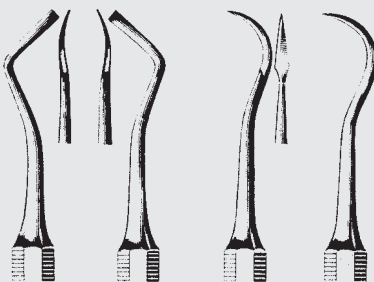

BLACK
83-3103-09 83-3103-10 83-3103-11 83-3103-12
Fig. 9 Fig. 10 Fig. 11 Fig. 12

PARODONTOLOGIE

PARODONTOLOGY

PARODONTOLOGIE

PARADONTOLOGÍA

PARADONTOLOGIA

ZEPF
&
INSTRUMENTS

83-3103-12

83.15



Zahnreiniger, Feilen
 Scalers, Files
 Détartreurs, Limes
 Limpiadores de sarro, Limas
 Strumenti per detartraggio, Lime

PARADONTOLOGIE

PARADONTOLOGY

PARADONTOLOGIE

PARADONTOLOGÍA

PARADONTOLOGIA

Feilen, Küretten
 Files, Curettes
 Limes, Curettes
 Limas, Curetas
 Lime, Curette



83-3104-01

83.16

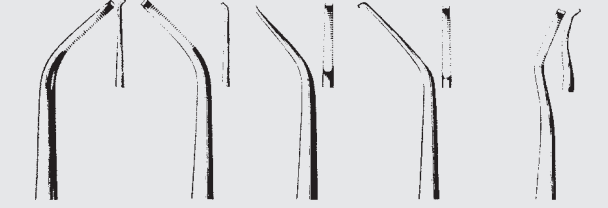

TOMPKINS				
83-3104-01	83-3104-02	83-3104-03	83-3104-04	83-3104-05
Fig. 1	Fig. 2	Fig. 3	Fig. 4	Fig. 5

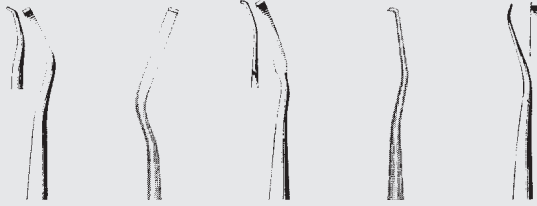

TOMPKINS				
83-3104-06	83-3104-07	83-3104-08	83-3104-11	83-3104-12
Fig. 6	Fig. 7	Fig. 8	Fig. 11	Fig. 12

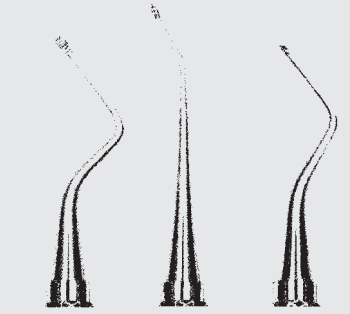
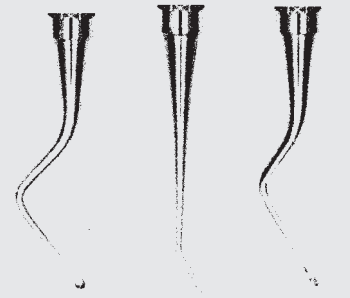

Fig. 3/7 Fig. 9/10 Fig. 5/11



HIRSCHFELD
 83-3105-07 83-3105-10 83-3105-11

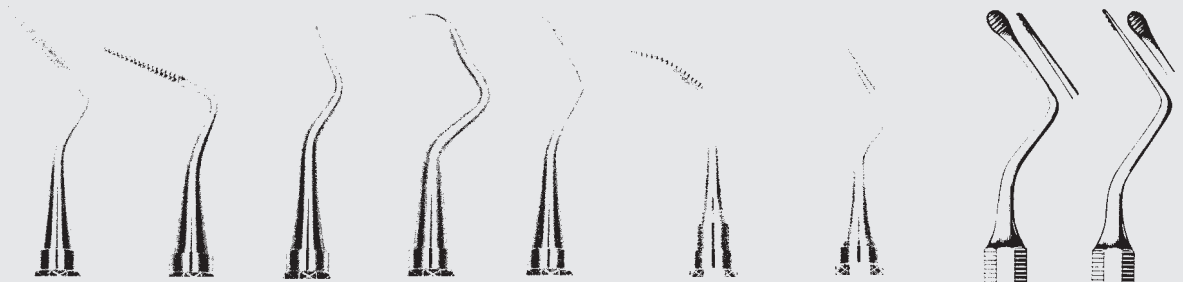
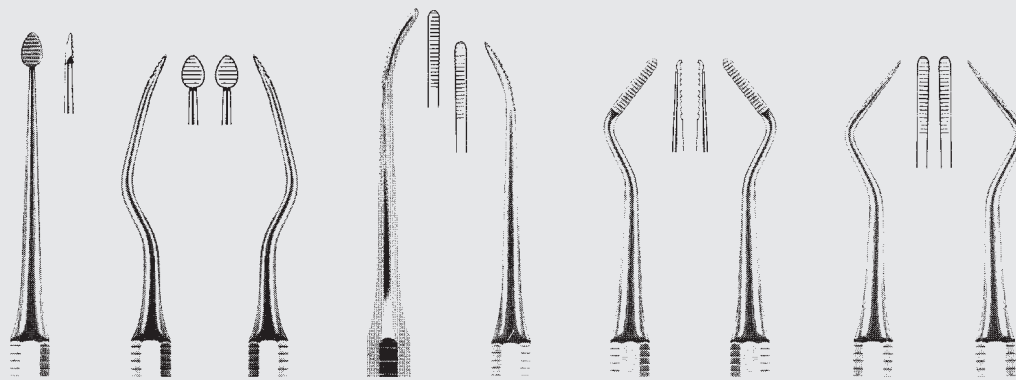

Fig. 15/25 Fig. 3S/4S Fig. 5S/6S Fig. 9S/10S Fig. 11S/12S Fig. 9/10 Fig. 11/12 Fig. 7 Fig. 8



SUGARMAN SCHLUGER BUCK MUEHLEMANN
 83-3106-02 83-3106-03 83-3106-05 83-3106-09 83-3106-11 83-3106-16 83-3106-21 83-3109-07 83-3109-08



BUNTING

83-3117-10	83-3117-11	83-3117-12	83-3117-13	83-3117-14	83-3117-15	83-3117-16	83-3117-17	83-3117-18
Fig. 10	Fig. 11	Fig. 12	Fig. 13	Fig. 14	Fig. 15	Fig. 16	Fig. 17	Fig. 18

Feilen für Wurzeln
Files for Roots
Limes pour racines
Limas para raíces
Lime per radici

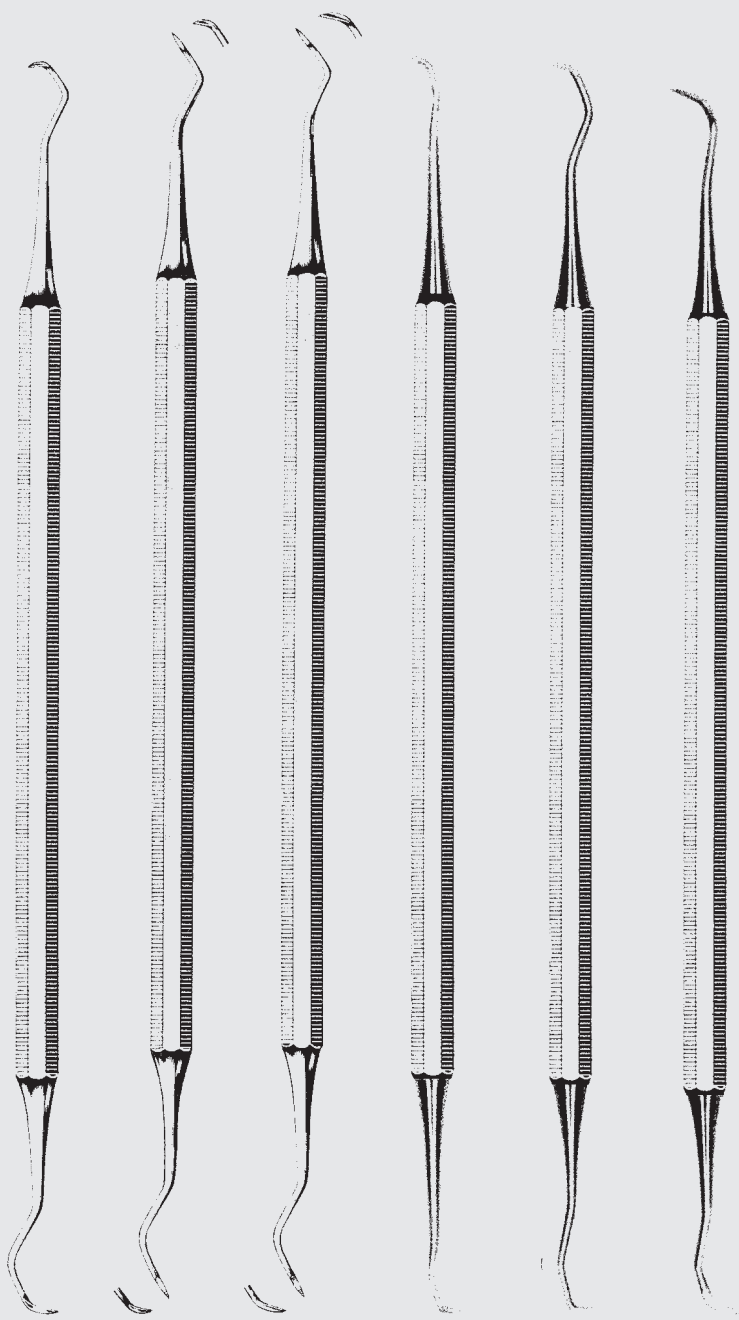

JACQUETTE

83-3203-01	83-3203-02	83-3203-03	83-3203-04	83-3203-05	83-3203-06
Fig. 30/31	Fig. 31/32	Fig. 34/35	Fig. 37/38	Fig. H3/H4	Fig. 14/15

PARODONTOLOGIE

PARODONTOLOGY

PARODONTOLOGIE

PARADONTOLOGÍA

PARADONTOLOGIA

Zahnreiniger
Scalers
Détartreurs
Limpiadores de sarro
Strumenti per detartraggio



83-3203-06

83.17

Zahnreiniger
 Scalers
 Détartreurs
 Limpiadores de sarro
 Strumenti per detartraggio

PARODONTOLOGIE

PARADONTOLOGY

PARODONTOLOGIE

PARADONTOLOGÍA

PARADONTOLOGIA

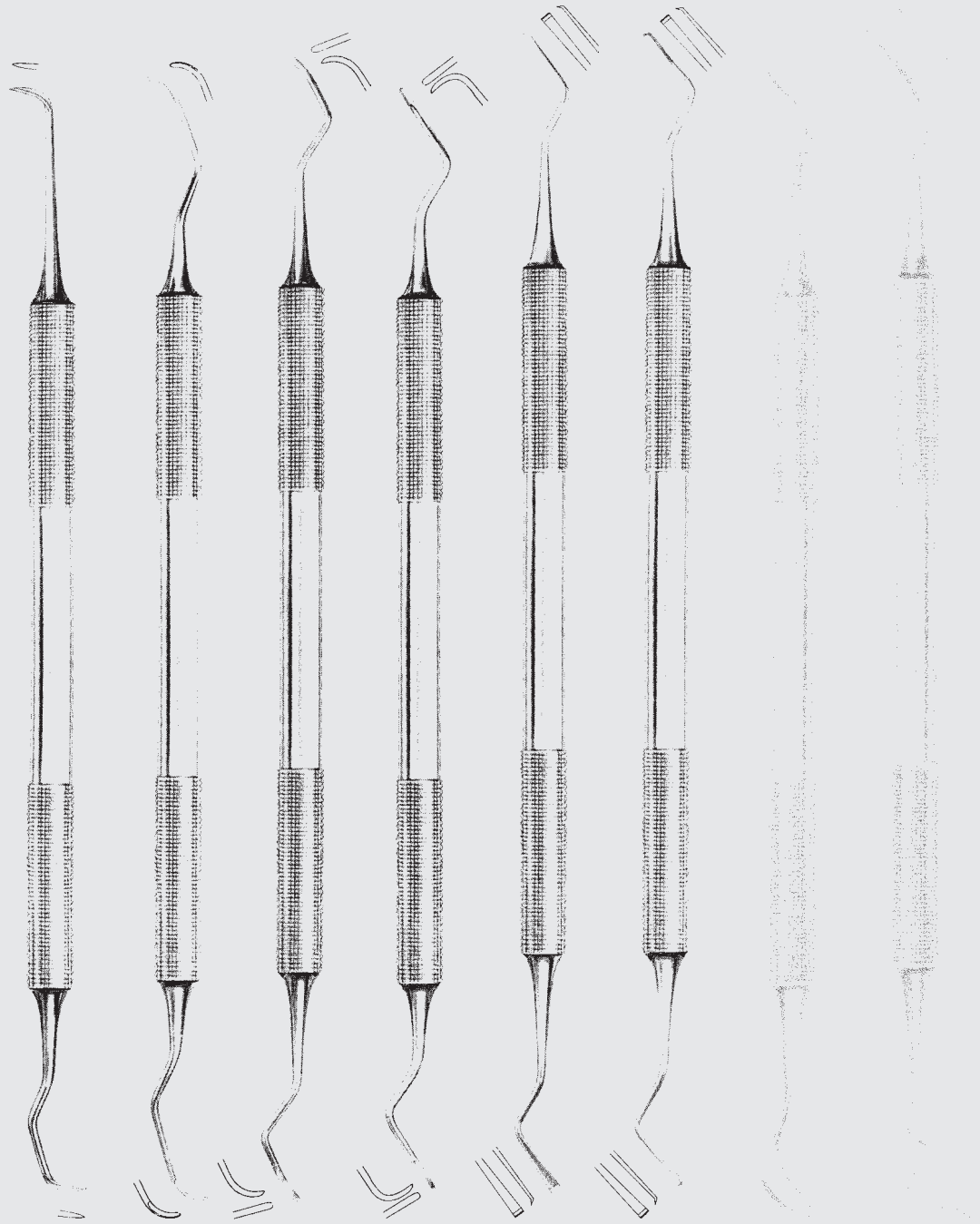

GOLDMAN FOX

83-3206-01	83-3206-02	83-3206-03	83-3206-04	83-3206-05	83-3206-06	83-3206-07	83-3206-08
Fig. 1	Fig. 2	Fig. 3	Fig. 4	Fig. 5	Fig. 6	Fig. 7	Fig. 8



83-3206-01

83.18

Gingivektomie-Messer, Kùretten
 Ginivectomy Knives, Currettes
 Couteaux à gingivectomie, Currettes
 Cuchillos para gingivectomía, Curretas
 Coltelli per gingivectomia, Curette

PARODONTOLOGIE

PARODONTOLOGY

PARODONTOLOGIE

PARADONTOLOGÍA

PARADONTOLOGIA



GOLDMAN FOX			
83-3206-09	83-3206-10	83-3206-11	83-3206-21
Fig. 09	Fig. 10	Fig. 11	Fig. 21

GRACEY			
83-3207-02	83-3207-04	83-3207-06	83-3207-08
Fig. 1/2	Fig. 3/4	Fig. 5/6	Fig. 7/8



83-3207-08

83.19

Küretten, Reiniger
 Curettes, Scalers
 Curettes, Déartreurs
 Curetas, Limpiadores de sarro
 Curette, strumenti per detartraggio

PARODONTOLOGIE

PARADONTOLOGY

PARODONTOLOGIE

PARADONTOLOGÍA

PARADONTOLOGIA



GRACEY				
83-3207-10	83-3207-11	83-3207-12	83-3207-13	83-3207-14
Fig. 9/10	Fig. 11/14	Fig. 11/12	Fig. 12/13	Fig. 13/14

CRANE CAPLAN	
83-3208-06	83-3208-61
CK6	CK6D

83-3209-24
Fig. 204S

PRICHARD
83-3300-00



83-3207-10
 83.20

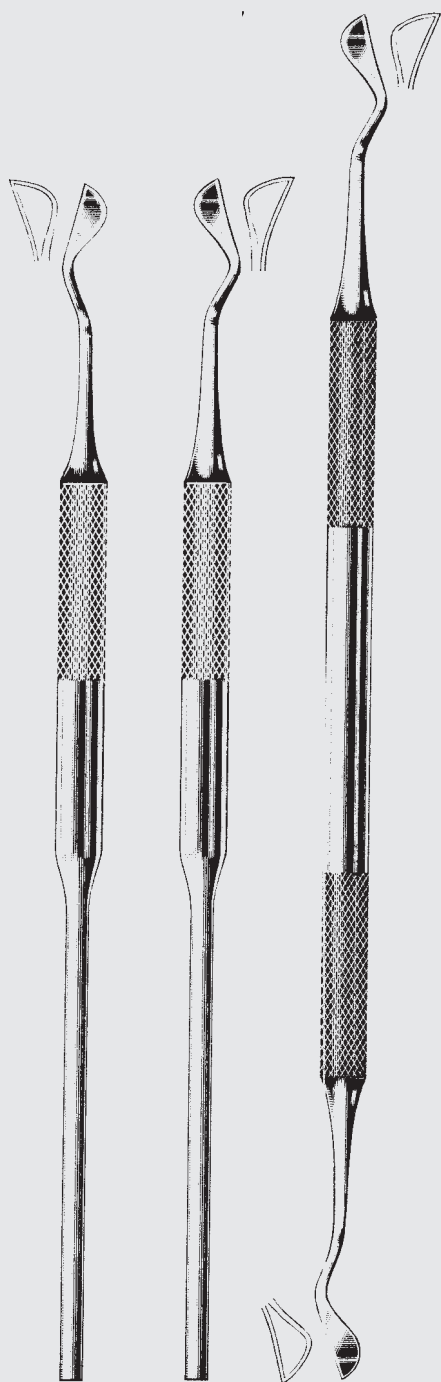

KIRKLAND

83-3301-15 83-3301-16 83-3302-16
 Fig. 15 Fig. 16 Fig. 15/16

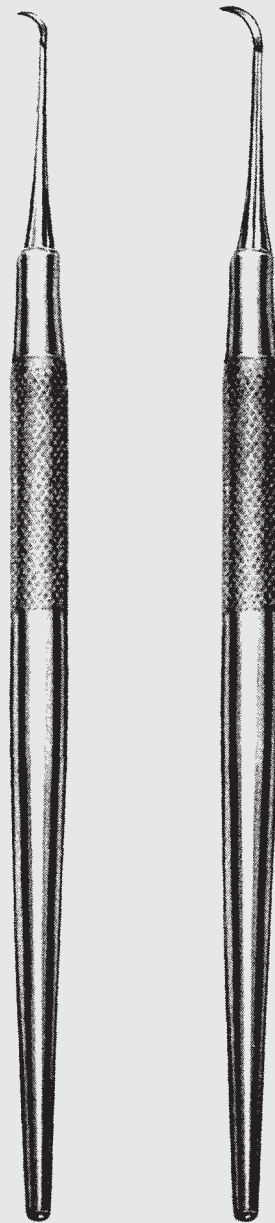

WHITESIDE

83-3304-02
 WH2

83-3304-28

USC 128

Periodontie-Messer, Reiniger
 Periodontal Knives, Scalers
 Couteaux parodontaux, Détartreurs
 Cuchillos periodontales, Limpiadores de sarro
 Coltelli parodontali, Strumenti per detartraggio

PARODONTOLOGIE

PARODONTOLOGY

PARODONTOLOGIE

PARADONTOLOGÍA

PARADONTOLOGIA

Inhalt · Contents · Contenu · Contenido · Contenuto

- | | |
|----------------|----------------|
| 1 x 08-8201-13 | 1 x 83-3206-09 |
| 1 x 83-3206-01 | 1 x 83-3206-10 |
| 1 x 83-3206-02 | 1 x 83-3206-11 |
| 1 x 83-3206-03 | 1 x 83-3306-02 |
| 1 x 83-3206-04 | 1 x 83-3403-01 |
| 1 x 83-3206-05 | 1 x 83-3403-02 |
| 1 x 83-3206-06 | 1 x 83-3404-01 |
| 1 x 83-3206-07 | |

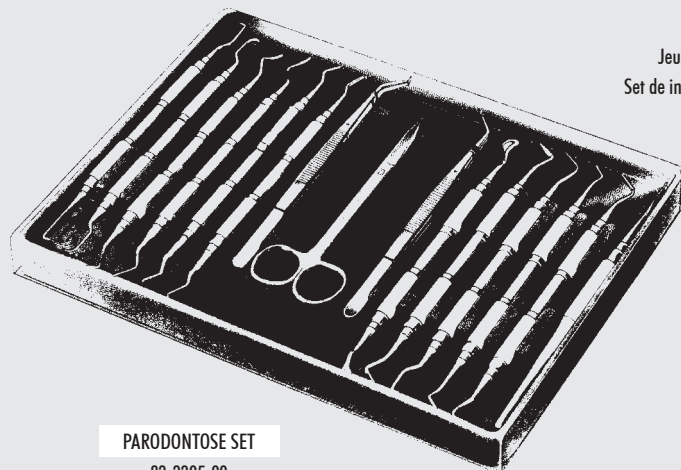

PARADONTOSE SET

83-3305-00

Parodontal Set, komplett
 Periodontal Surgical Kit, Complete
 Jeu d'instruments de chirurgie parodontale, complet
 Set de instrumental para la cirugía periodontal, completo
 Set di chirurgia parodontale completo

ZEPF[®]
INSTRUMENTS

83-3305-00

83.21

Gingivektomie-Messer
Periodontal Knives
Bistouris paradontaux
Bisturías para gingivectomía
Bisturi paradontali

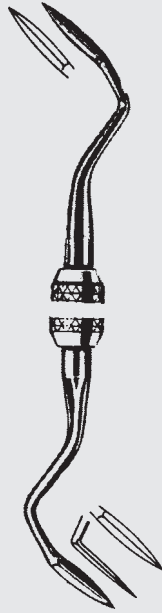

ORBAN
83-3306-04

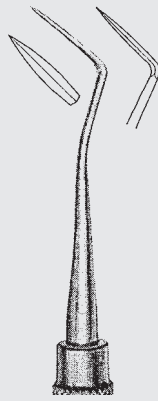

ORBAN
83-3307-05

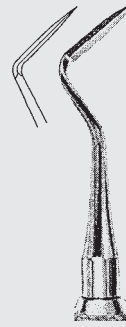

ORBAN
83-3309-01

Fig. 1



ORBAN
83-3309-02

Fig. 2

PARODONTOLOGIE

PARODONTOLOGY

PARODONTOLOGIE

PARADONTOLOGÍA

PARADONTOLOGIA

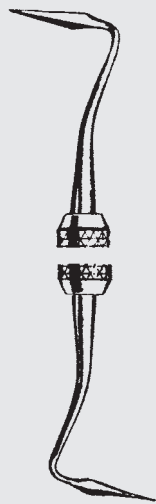

BUCK
83-3307-06

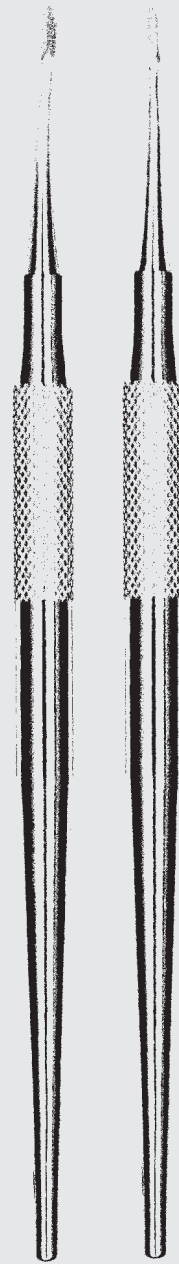

ORBAN
83-3400-21 83-3400-22

Fig. 21

Fig. 22

Markierpinzetten, Parodontometer
 Pocket Markers, Peridontal Probes
 Pincés à marquer la poche, Sondes parodontales
 Pinzas para marcar el sulco periodontal, Sondas parodontales
 Pinzette segnatasche, Sonde parodontali

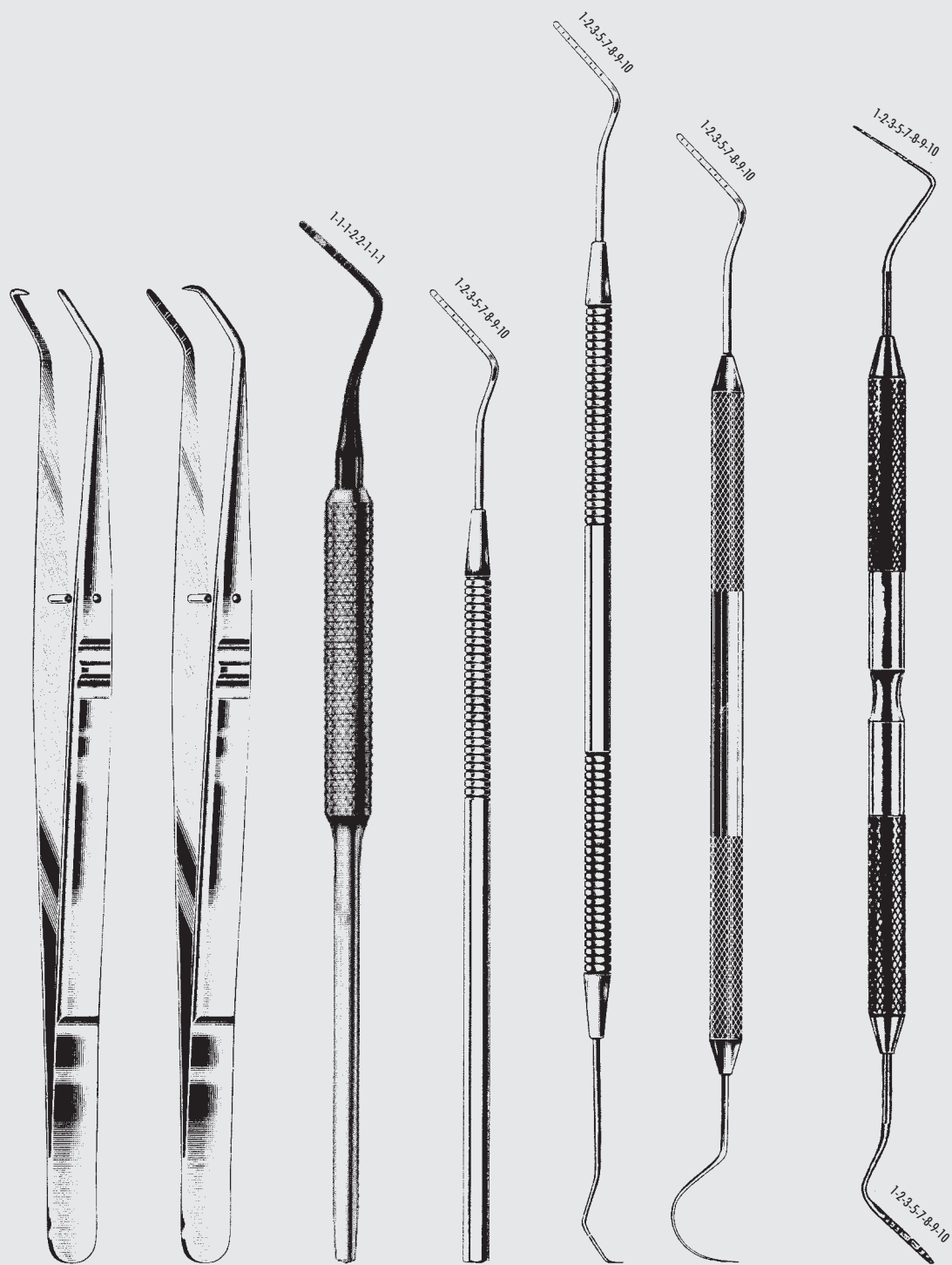

CRANE CAPLAN
 83-3403-01 83-3403-02
 Fig. 1 Fig. 2

83-3404-01

83-3405-01

83-3406-01

83-3406-02
 Fig. 23/W

GOLDMAN FOX-WILLIAMS
 83-3406-10

DIAGNOSTIK
 DIAGNOSTICS
 DIAGNOSTIC
 DIAGNÓSTICO
 DIAGNOSTICA



83-3406-10

83.23

Medikamenten-Ösen, Parodontometer

Loops for Introducing Medicaments, Periodontal Probes

Anses pour introduire des médicaments, Sondes parodontales

Asas para introducir medicamentos, Sondas parodontales

Anse per introdurre medicamenti, Sonde parodontali

DIAGNOSTIK

DIAGNOSTICS

DIAGNOSTIC

DIAGNÓSTICO

DIAGNOSTICA



HAUER
83-3407-08
PCP8



KRENN
83-3409-02



83-3502-08
Fig. 8



83-3502-10
Fig. 10



83-3502-11
Fig. 11



83-3503-00
MICHIGAN
Fig. 0



83-3504-00
WILLIAMS
Fig. W



83-3505-00
Fig. WHO



83-3507-01
Fig. 1N



83-3507-02
Fig. 2N

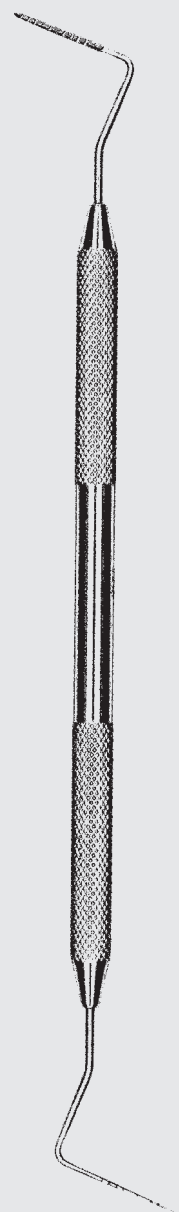

83-3507-03
Fig. 3N

Schmelz Meissel
Enamel Chisels
Ciseaux à émail
Cinceles para esmalte
Strumenti tagliasmalto

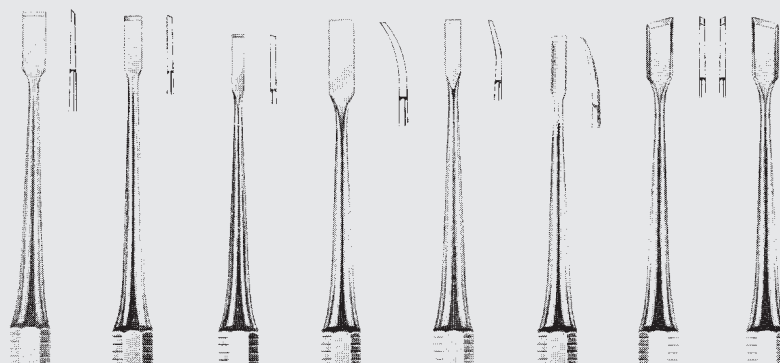

WHITE							
83-3600-03	83-3600-04	83-3600-05	83-3600-06	83-3600-07	83-3600-09	83-3600-33	83-3600-34
Fig. 3	Fig. 4	Fig. 5	Fig. 6	Fig. 7	Fig. 9	Fig. 33	Fig. 34

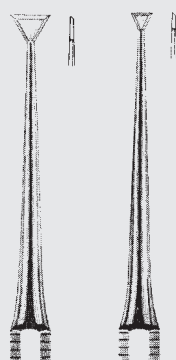

WHITE	
83-3600-48	83-3600-49
Fig. 48	Fig. 48S

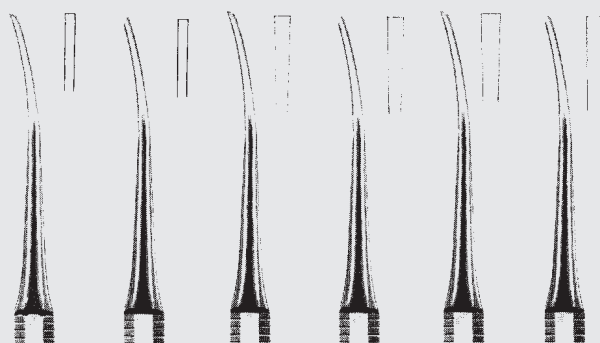

WHITE
83-3600-02
Fig. 2

WEDELSTAEDT					
83-3601-39	83-3601-40	83-3601-41	83-3601-42	83-3601-43	83-3601-44
Fig. 39	Fig. 40	Fig. 41	Fig. 42	Fig. 43	Fig. 44

KONSERVIERENDE
ZAHNBEHANDLUNG

CONSERVATION
OF TEETH

DENTISTERIE
CONSERVATRICE

ODONTOLOGÍA
CONSERVADORA

ODONTOLOGIA
CONSERVATIVA

ZEPF[®]
α
INSTRUMENTS

83-3601-44

83.25

Schnitzinstrumente
Carvers
Sculpteurs
Talladores
Modellatori per amalgama

KONSERVIERENDE
ZAHNBEHANDLUNG

CONSERVATION
OF TEETH

DENTISTERIE
CONSERVATRICE

ODONTOLOGÍA
CONSERVADORA

ODONTOLOGIA
CONSERVATIVA

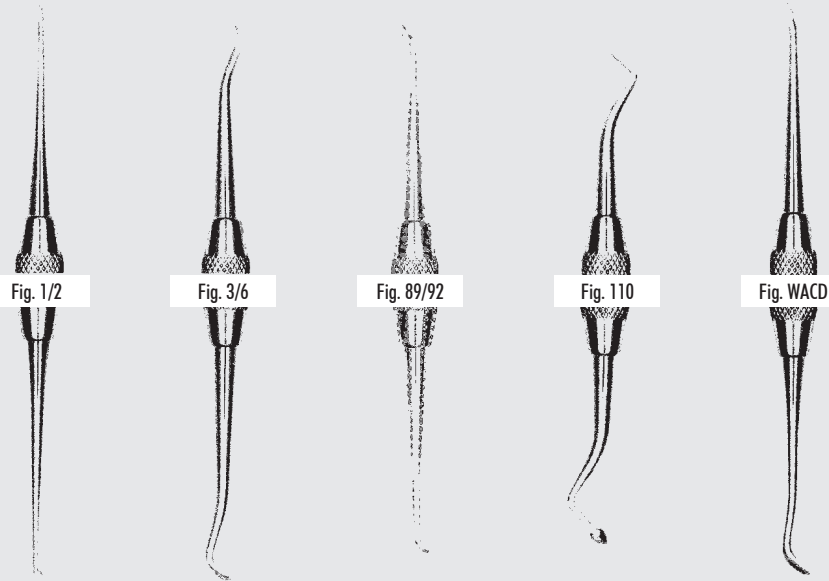

Discoids-Cleoids
83-3602-01 83-3602-03 83-3602-09 83-3602-11 83-3602-19

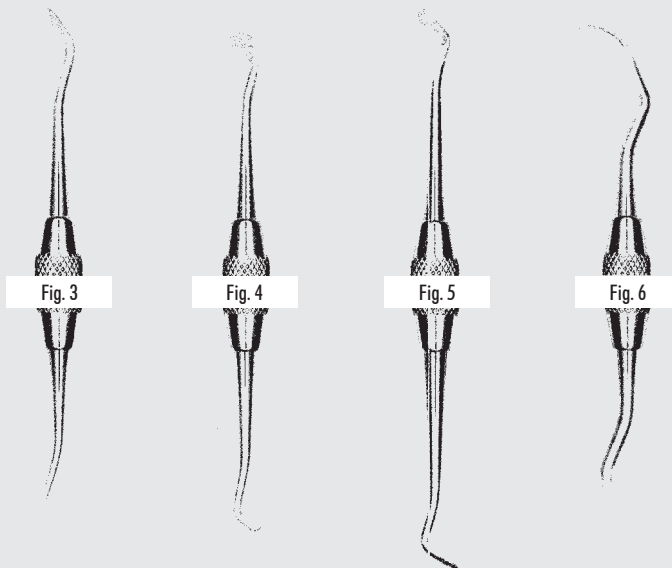

TANNER
83-3603-03 83-3603-04 83-3603-05 83-3603-06



83-3602-01

83.26

Sonden
Explorers
Sondes
Sondas
Sonde

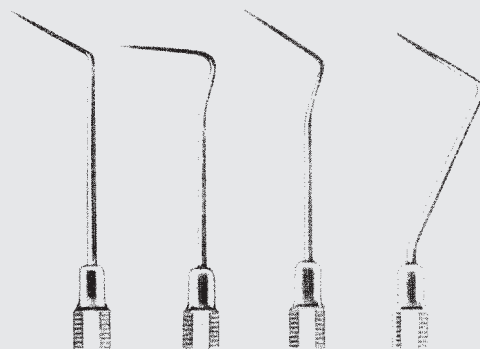

83-3901-06 83-3901-08 83-3901-09 83-3901-10
Fig. 6 Fig. 8 Fig. 9 Fig. 10



83-3901-02
Fig. 2

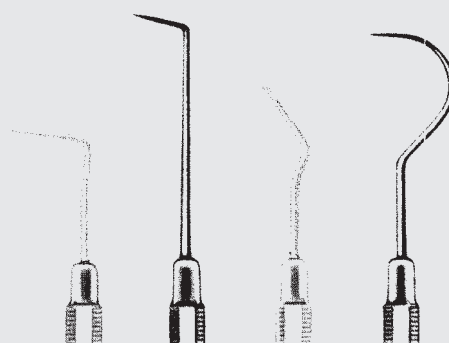

83-3901-11 83-3901-16 83-3901-17 83-3901-23
Fig. 11 Fig. 16 Fig. 17 Fig. 23



83-3901-65 83-3901-66
Fig. 65 Fig. 66

DIAGNOSTIK

DIAGNOSTICS

DIAGNOSTIC

DIAGNÓSTICO

DIAGNOSTICA



83-3901-66

83.27

Sonden
Explorers
Sondes
Sondas
Sonde

DIAGNOSTIK

DIAGNOSTICS

DIAGNOSTIC

DIAGNÓSTICO

DIAGNOSTICA

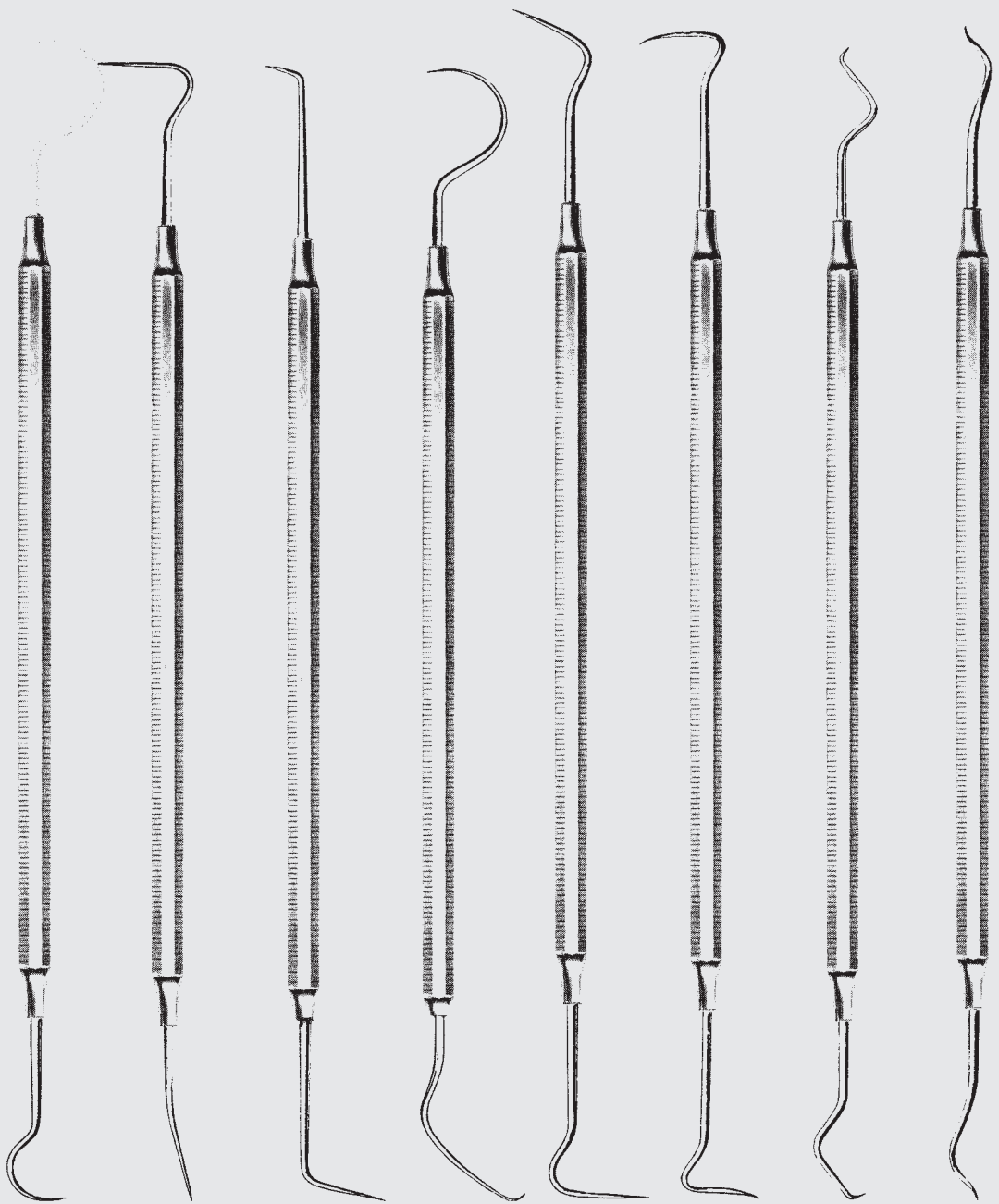

83-3902-02

Fig. 2

83-3902-05

Fig. 5

83-3902-06

Fig. 6

83-3902-07

Fig. 7

83-3902-08

Fig. 8

SCHEFF

83-3902-10

Fig. 10

BRIAULT

83-3902-11

Fig. 11

WESTON

83-3902-12

Fig. 12



83-3902-02

83.28

Sonden
Explorers
Sondes
Sondas
Sonde

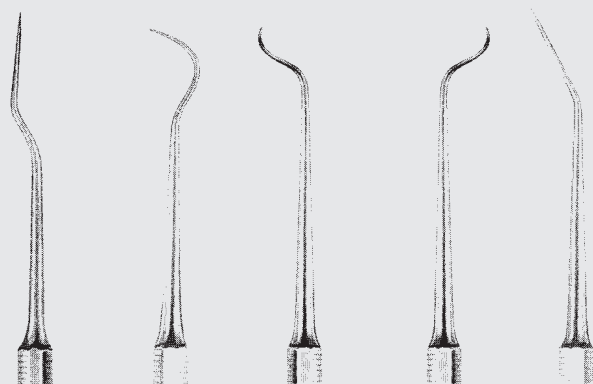

83-3904-01	83-3904-02	83-3904-03	83-3904-04	83-3904-05
Fig. 1	Fig. 2	Fig. 3	Fig. 4	Fig. 5

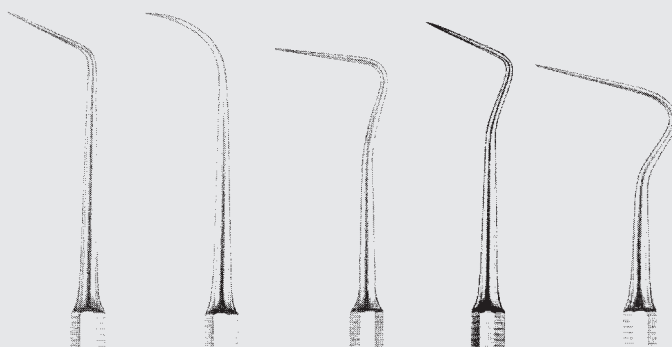
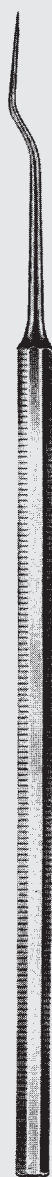

83-3904-06	83-3904-07	83-3904-08	83-3904-09	83-3904-18
Fig. 6	Fig. 7	Fig. 8	Fig. 9	Fig. 18

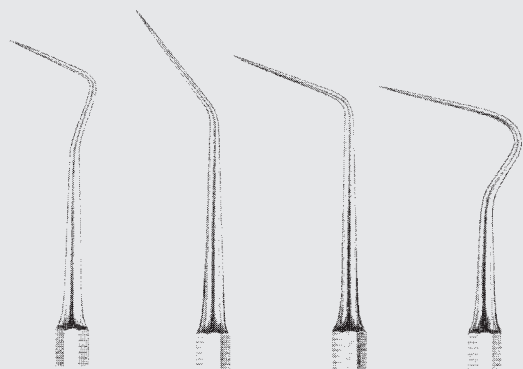

83-3904-19	83-3904-51	83-3904-61	83-3904-81
Fig. 19	Fig. 5A	Fig. 6A	Fig. 8A

DIAGNOSTIK

DIAGNOSTICS

DIAGNOSTIC

DIAGNÓSTICO

DIAGNOSTICA



83-3904-81

83.29

Sonden
Explorers
Sondes
Sondas
Sonde

DIAGNOSTIK

DIAGNOSTICS

DIAGNOSTIC

DIAGNÓSTICO

DIAGNOSTICA



83-3906-05

Fig. 5/6



SCHEFF

83-3906-10

Fig. 10



BRIAULT

83-3906-11

Fig. 11



WESTON

83-3906-12

Fig. 12



83-3906-05

83.30

Sonden
Explorers
Sondes
Sondas
Sonde



HOSPITAL
83-3907-14
Fig. 14



83-3907-37
Fig. 37



83-3907-48
Fig. 48



83-3907-49
Fig. 49



83-3907-54
Fig. 54



HOLST
83-3907-55
Fig. 55



HOLST „A“
83-3907-65
Fig. 65

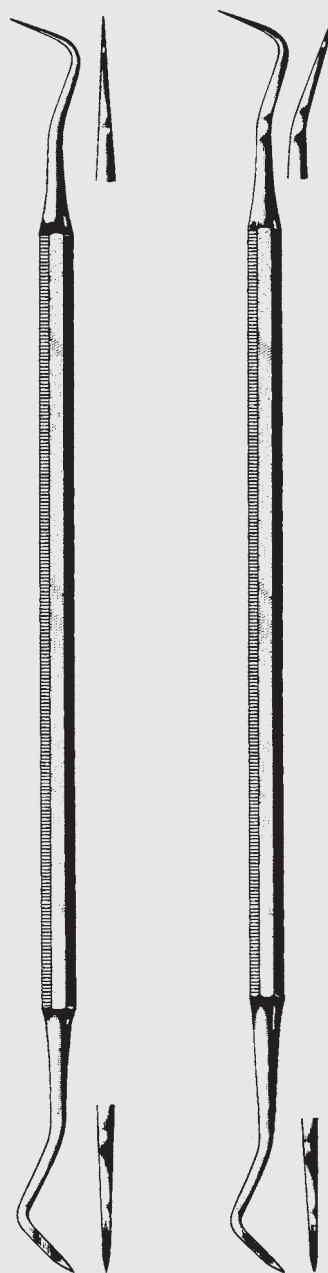

LANGE
83-3909-01 83-3909-02
Fig. 1 Fig. 2

DIAGNOSTIK

DIAGNOSTICS

DIAGNOSTIC

DIAGNÓSTICO

DIAGNOSTICA

ZEPF[®]
α
INSTRUMENTS

83-3909-02

83.31

Sonden
Explorers
Sondes
Sondas
Sonde

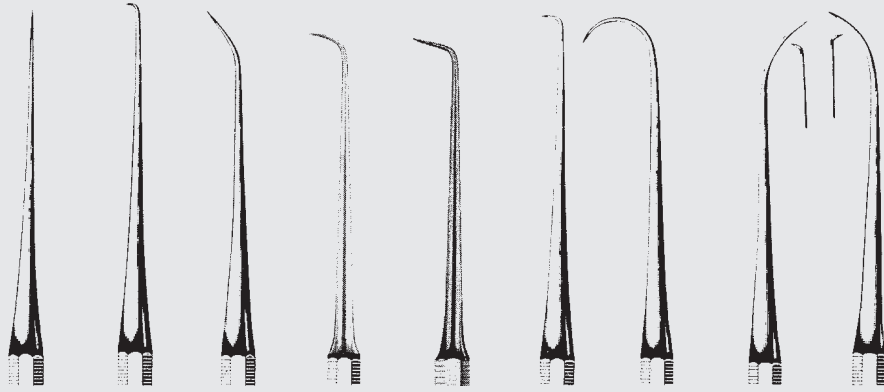

WHITE								
83-4001-01	83-4001-02	83-4001-03	83-4001-05	83-4001-06	83-4001-07	83-4001-08	83-4001-09	83-4001-10
Fig. 1	Fig. 2	Fig. 3	Fig. 5	Fig. 6	Fig. 7	Fig. 8	Fig. 9	Fig. 10

DIAGNOSTIK

DIAGNOSTICS

DIAGNOSTIC

DIAGNÓSTICO

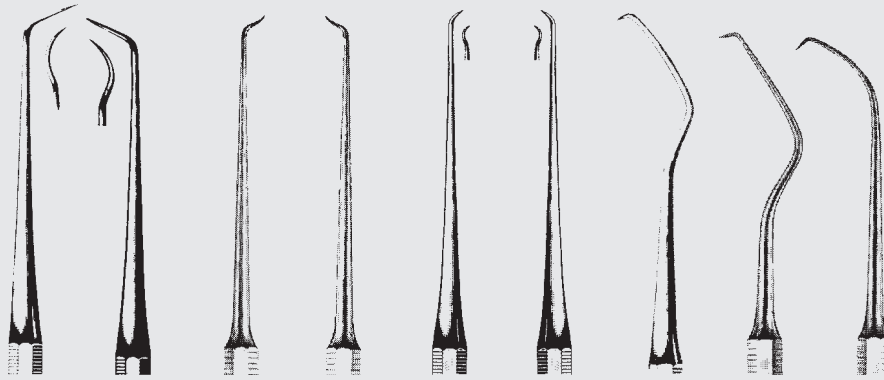

WHITE								
83-4001-11	83-4001-12	83-4001-13	83-4001-14	83-4001-15	83-4001-16	83-4001-17	83-4001-18	83-4001-20
Fig. 11	Fig. 12	Fig. 13	Fig. 14	Fig. 15	Fig. 16	Fig. 17	Fig. 18	Fig. 20

DIAGNOSTICA

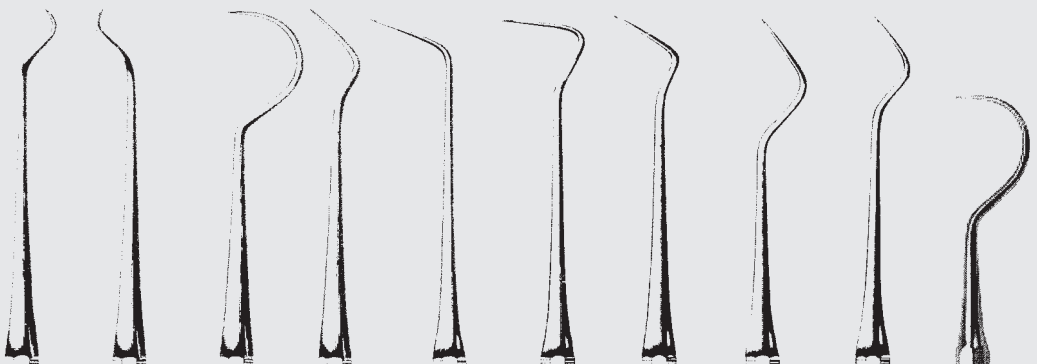

WHITE									
83-4001-21	83-4001-22	83-4001-23	83-4001-33	83-4001-40	83-4001-42	83-4001-43	83-4001-44	83-4001-45	83-4001-54
Fig. 21	Fig. 22	Fig. 23	Fig. 33	Fig. 40	Fig. 42	Fig. 43	Fig. 44	Fig. 45	Fig. 54

Sonden
Explorers
Sondas
Sondas
Sonde

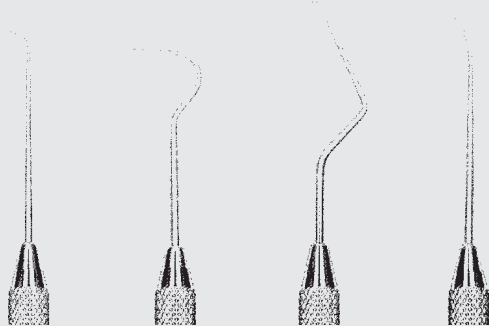

83-4005-06
Fig. 6

83-4005-08
Fig. 8

83-4005-09
Fig. 9

83-4005-17
Fig. 17



83-4005-03
Fig. 3

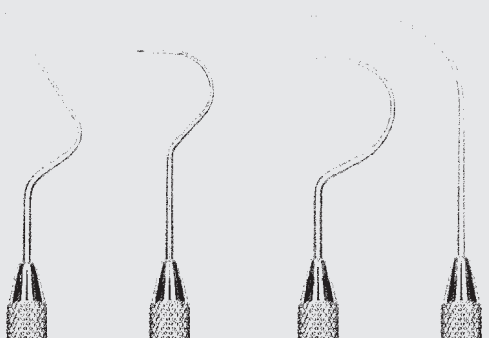

ORBAN
83-4005-20
Fig. 20

SHEPHERD
83-4005-23
Fig. 23

83-4005-54
Fig. 54

83-4006-03
Fig. 3A

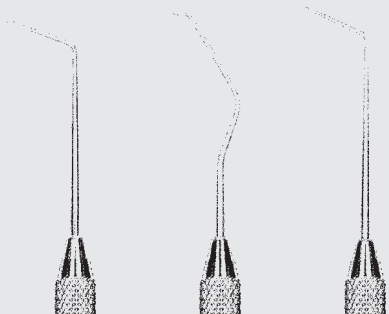

83-4006-06
Fig. 6A

83-4006-17
Fig. 17

83-4007-06
Fig. 6L

DIAGNOSTIK

DIAGNOSTICS

DIAGNOSTIC

DIAGNÓSTICO

DIAGNOSTICA



83-4007-06

83.33

Sonden
Explorers
Sondes
Sondas
Sonde

DIAGNOSTIK

DIAGNOSTICS

DIAGNOSTIC

DIAGNÓSTICO

DIAGNOSTICA

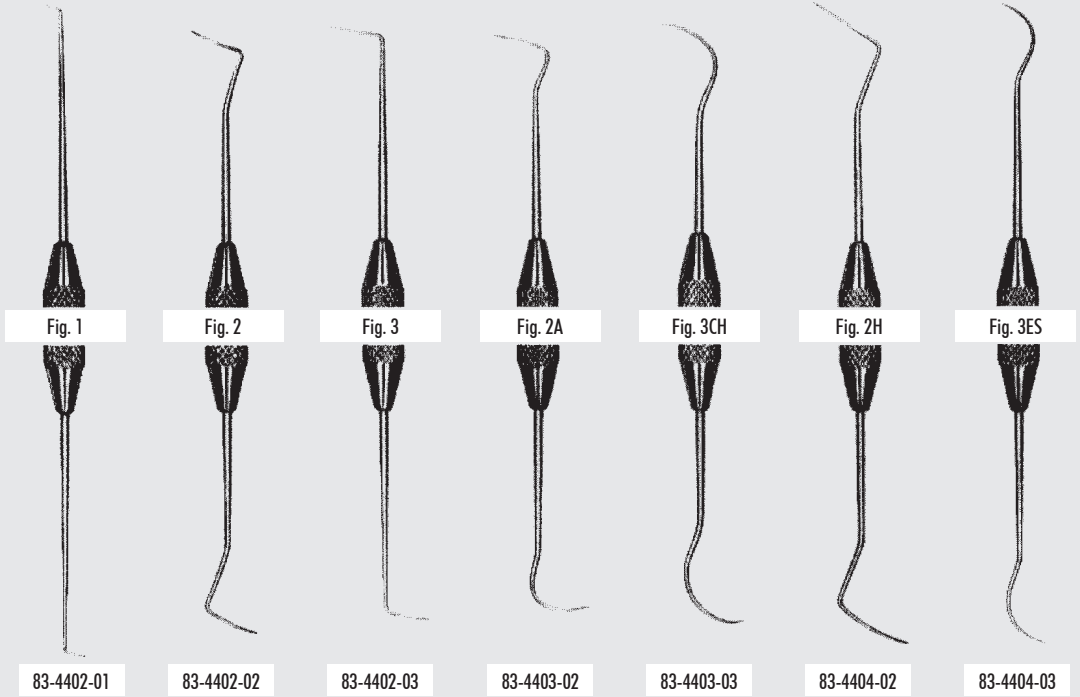
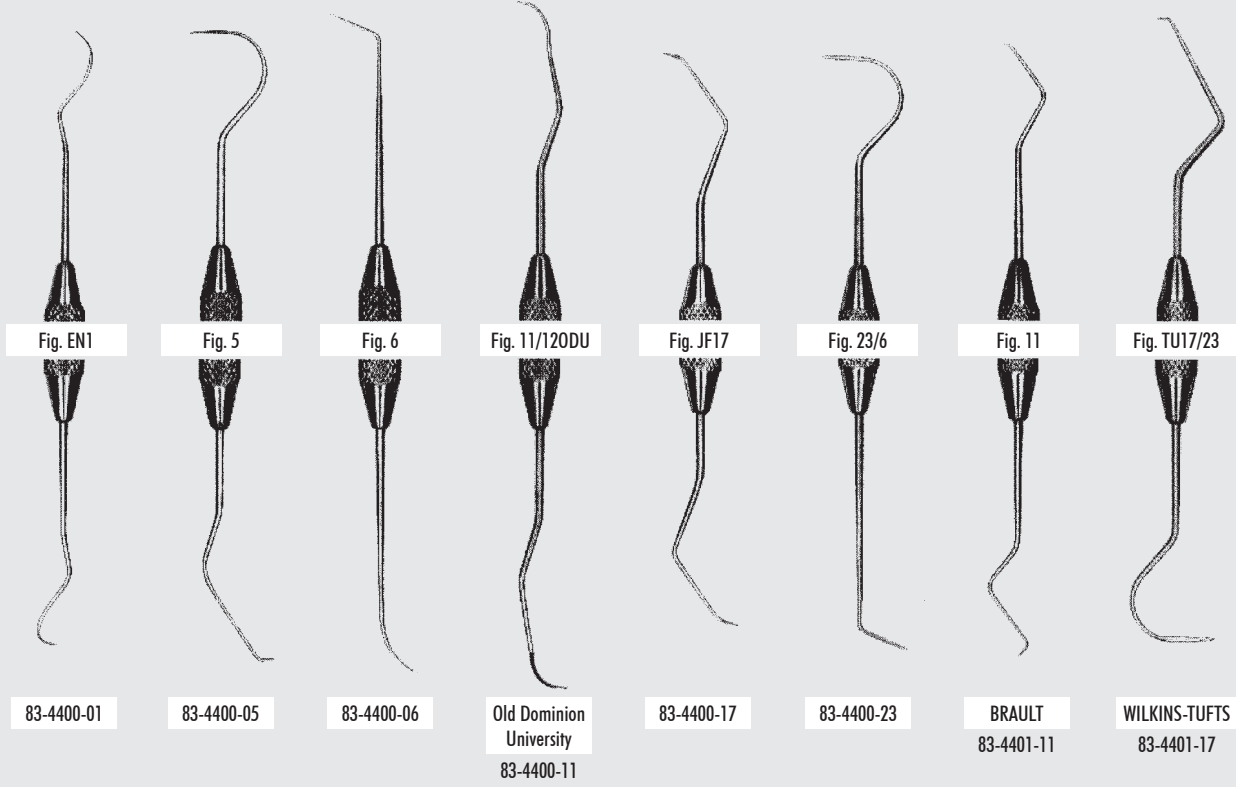

Exkavatoren
Excavators
Excavateurs
Excavadores
Escavatori

KONSERVIERENDE
ZAHNBEHANDLUNG

CONSERVATION
OF TEETH

DENTISTERIE
CONSERVATRICE

ODONTOLOGÍA
CONSERVADORA

ODONTOLOGIA
CONSERVATIVA



DARBY PERRY
83-4406-05
Fig. 5/6

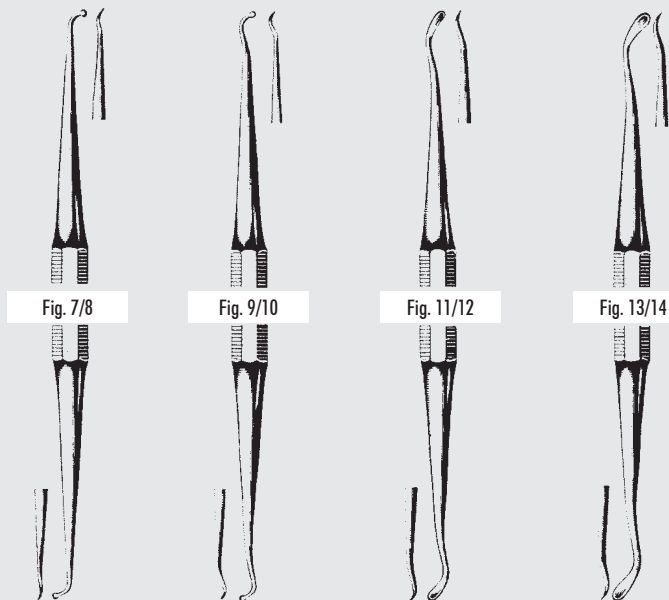

DARBY PERRY
83-4406-07 83-4406-09 83-4406-11 83-4406-13

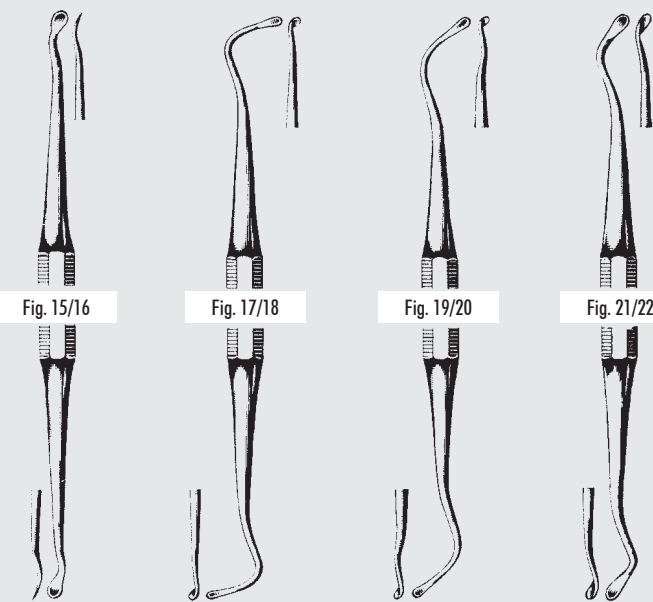

DARBY PERRY
83-4406-15 83-4406-17 83-4406-19 83-4406-21

ZEPF[®]
α
INSTRUMENTS

83-4406-21

83.35

Exkavatoren
Excavators
Excavateurs
Excavadores
Escavatori

KONSERVIERENDE
ZAHNBEHANDLUNG

CONSERVATION
OF TEETH

DENTISTERIE
CONSERVATRICE

ODONTOLOGÍA
CONSERVADORA

ODONTOLOGIA
CONSERVATIVA

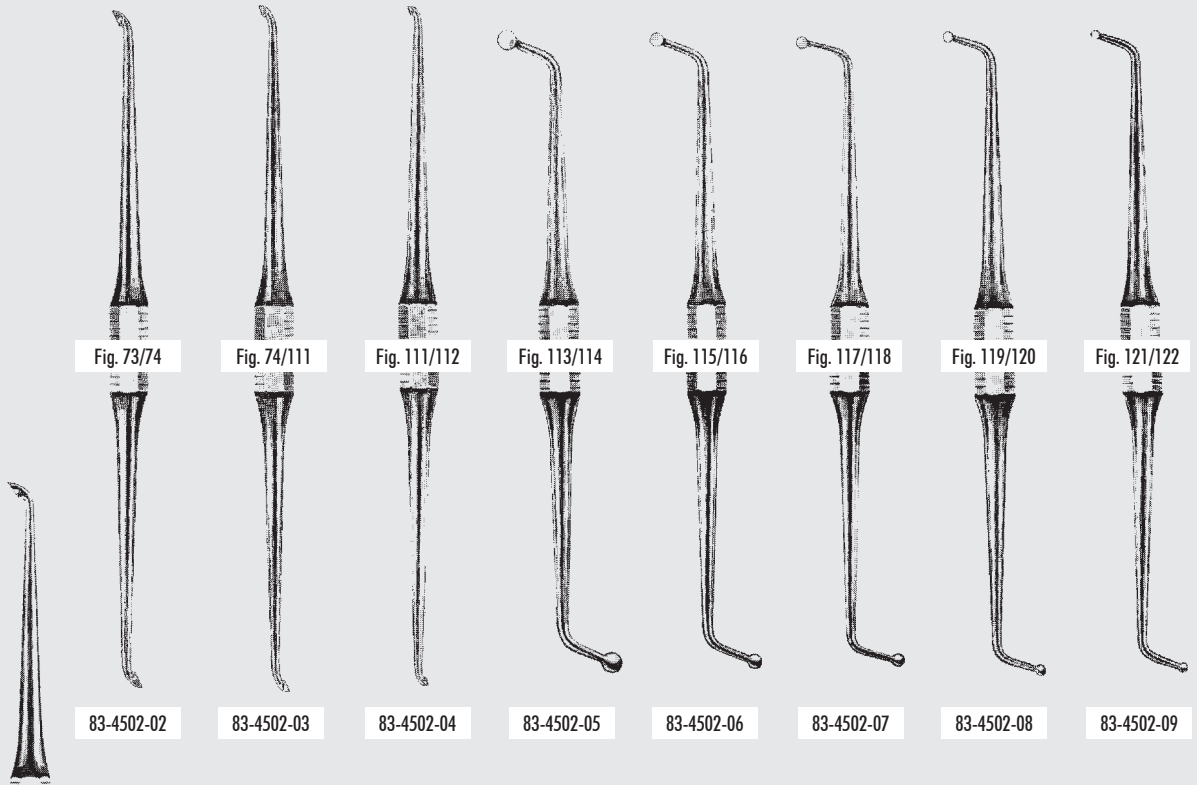

83-4502-01
Fig. 72/73

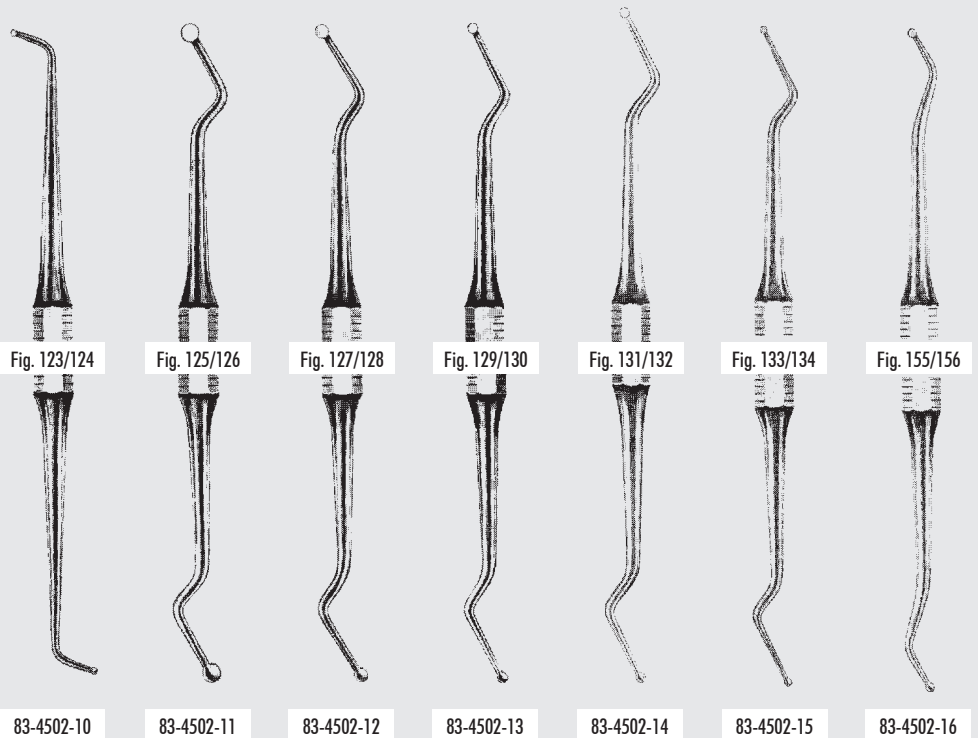

Exkavatoren
Excavators
Excavateurs
Excavadores
Escavatori

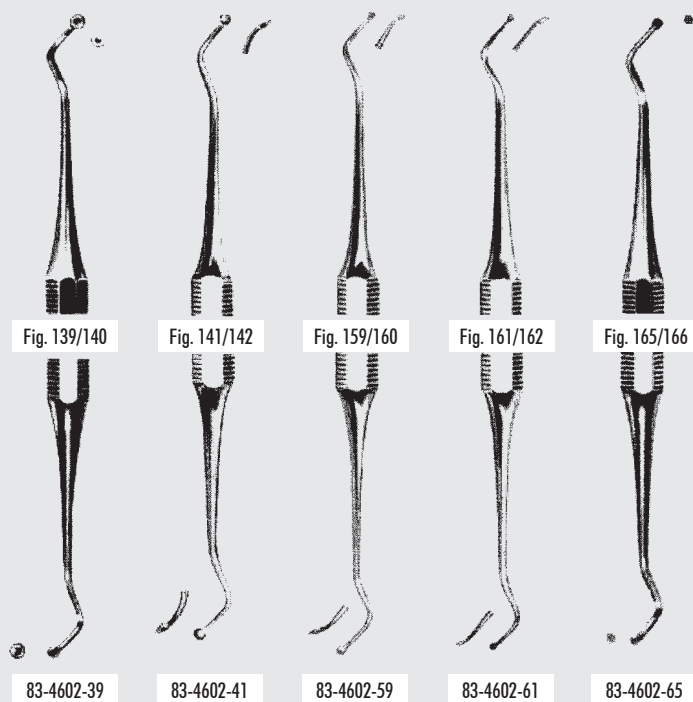

Fig. 139/140

Fig. 141/142

Fig. 159/160

Fig. 161/162

Fig. 165/166

83-4602-39

83-4602-41

83-4602-59

83-4602-61

83-4602-65

KONSERVIERENDE
ZAHNBEHANDLUNG

CONSERVATION
OF TEETH

DENTISTERIE
CONSERVATRICE

ODONTOLOGÍA
CONSERVADORA

ODONTOLOGIA
CONSERVATIVA

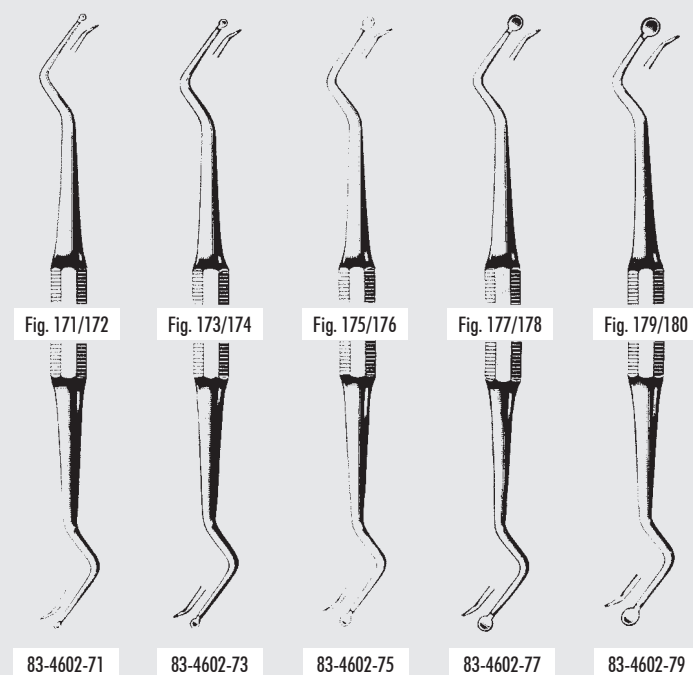

Fig. 171/172

Fig. 173/174

Fig. 175/176

Fig. 177/178

Fig. 179/180

83-4602-71

83-4602-73

83-4602-75

83-4602-77

83-4602-79

ZEPF[®]
α
INSTRUMENTS

83-4602-79

83.37

Exkavatoren
Excavators
Excavateurs
Excavadores
Escavatori

KONSERVIERENDE
ZAHNBEHANDLUNG

CONSERVATION
OF TEETH

DENTISTERIE
CONSERVATRICE

ODONTOLOGÍA
CONSERVADORA

ODONTOLOGIA
CONSERVATIVA

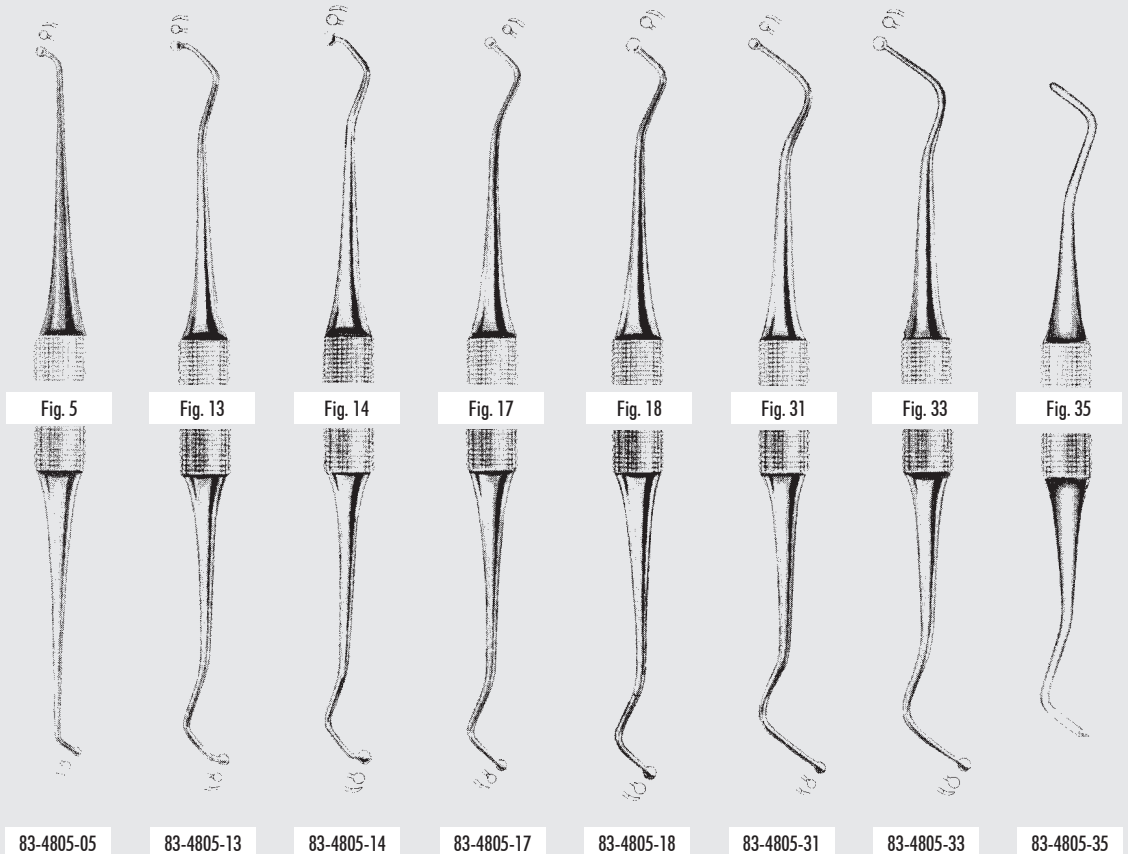
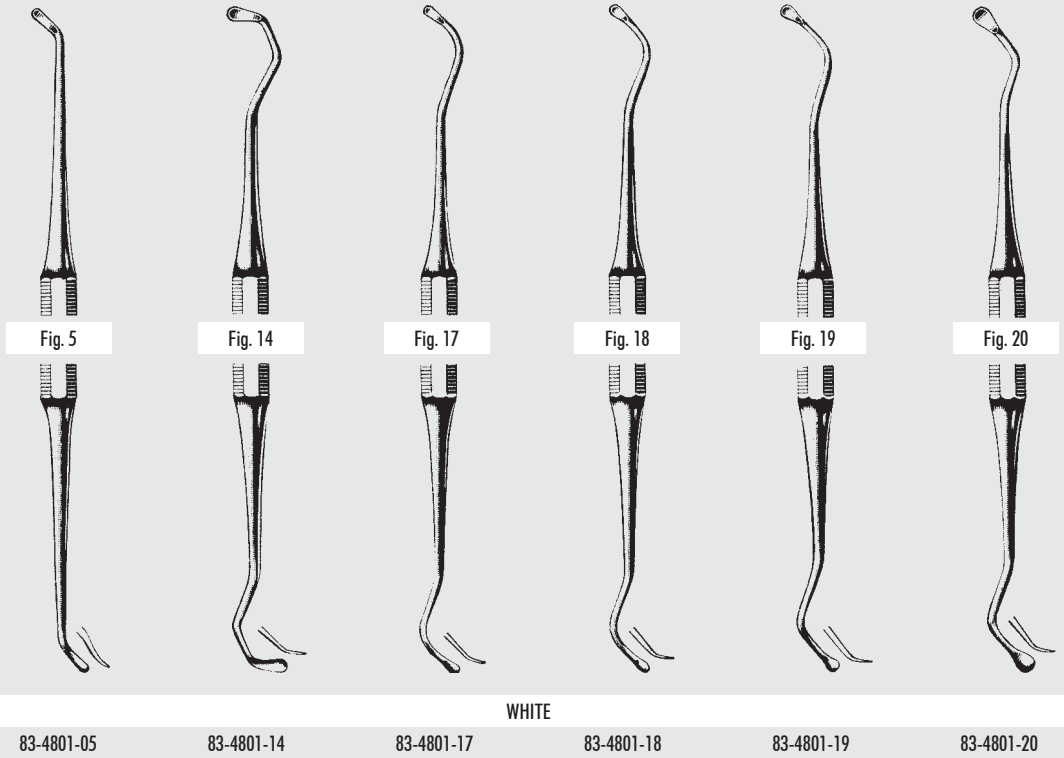

83-4801-05

83.38

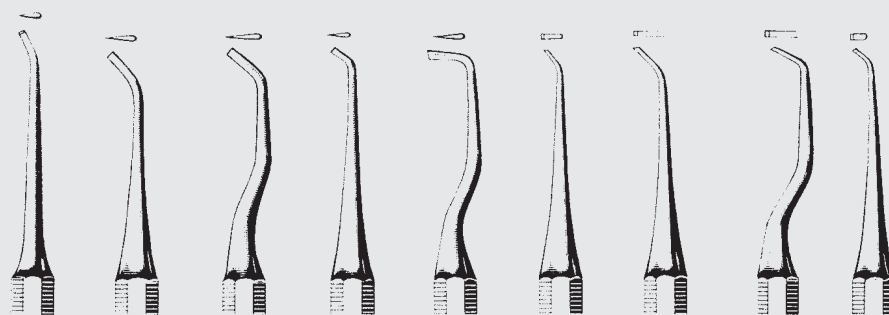

BLACK								
83-4901-03	83-4901-09	83-4901-14	83-4901-17	83-4901-20	83-4901-28	83-4901-32	83-4901-38	83-4901-41
Fig. 3	Fig. 9	Fig. 14	Fig. 17	Fig. 20	Fig. 28	Fig. 32	Fig. 38	Fig. 41

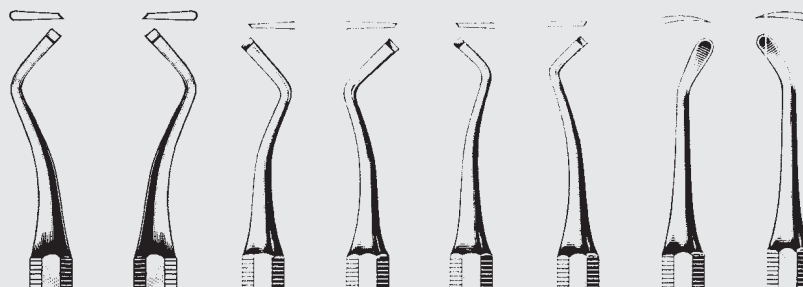

BLACK							
83-4901-49	83-4901-50	83-4901-51	83-4901-52	83-4901-53	83-4901-54	83-4901-57	83-4901-58
Fig. 49	Fig. 50	Fig. 51	Fig. 52	Fig. 53	Fig. 54	Fig. 57	Fig. 58

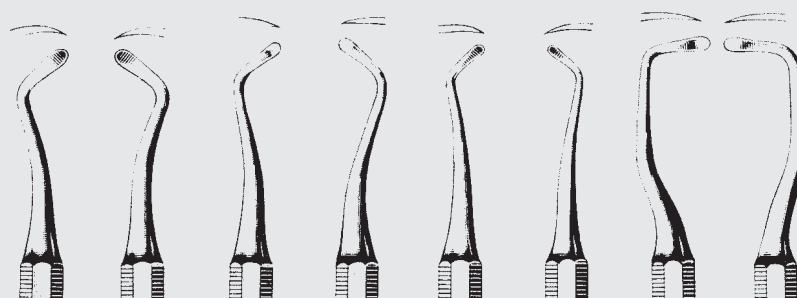

BLACK							
83-4901-61	83-4901-62	83-4901-63	83-4901-64	83-4901-65	83-4901-66	83-4901-69	83-4901-70
Fig. 61	Fig. 62	Fig. 63	Fig. 64	Fig. 65	Fig. 66	Fig. 69	Fig. 70

Schneidende Instrumente
Cutting Instruments
Instruments tranchants
Instrumentos cortantes
Strumenti taglienti

KONSERVIERENDE
ZAHNBEHANDLUNG

CONSERVATION
OF TEETH

DENTISTERIE
CONSERVATRICE

ODONTOLOGÍA
CONSERVADORA

ODONTOLOGIA
CONSERVATIVA

Schneidende Instrumente
Cutting Instruments
Instruments tranchants
Instrumentos cortantes
Strumenti taglienti

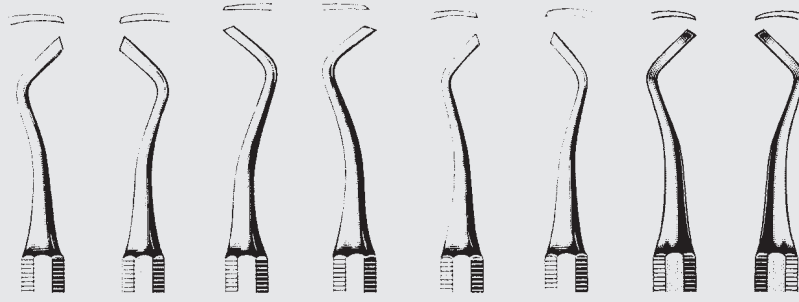

BLACK							
83-4901-73	83-4901-74	83-4901-75	83-4901-76	83-4901-77	83-4901-78	83-4901-79	83-4901-80
Fig. 73	Fig. 74	Fig. 75	Fig. 76	Fig. 77	Fig. 78	Fig. 79	Fig. 80

KONSERVIERENDE
ZAHNBEHANDLUNG

CONSERVATION
OF TEETH

DENTISTERIE
CONSERVATRICE

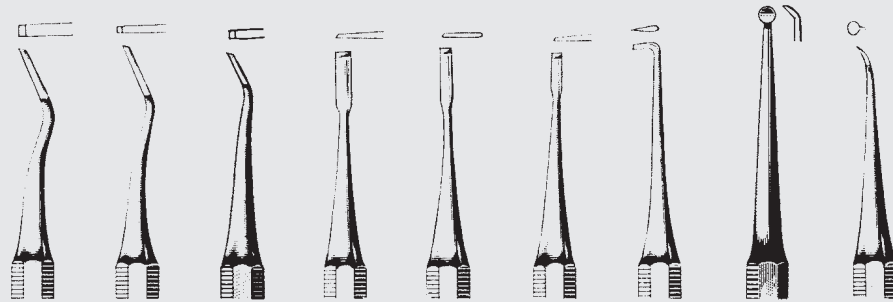

BLACK								
83-4901-81	83-4901-82	83-4901-83	83-4901-84	83-4901-85	83-4901-86	83-4901-87	83-4901-89	83-4901-90
Fig. 81	Fig. 82	Fig. 83	Fig. 84	Fig. 85	Fig. 86	Fig. 87	Discoid Fig. 89	Fig. 90

ODONTOLOGÍA
CONSERVADORA

ODONTOLOGIA
CONSERVATIVA

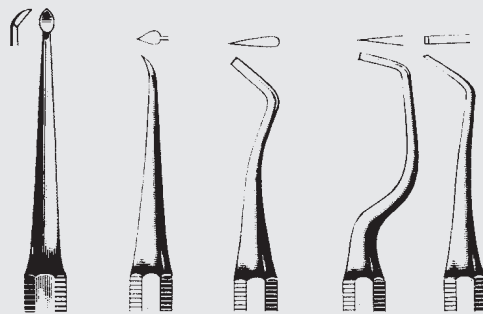

BLACK				
83-4901-92	83-4901-93	83-4901-95	83-4901-98	83-4901-99
Cleoid Fig. 92	Fig. 93	Fig. 95	Fig. 98	Fig. 99



Fig. 49/50



Fig. 51/52



Fig. 53/54



Fig. 57/58



Fig. 61/62



Fig. 63/64



BLACK

83-4902-49

83-4902-51

83-4902-53

83-4902-57

83-4902-61

83-4902-63

Schneidende Instrumente
Cutting Instruments
Instruments tranchants
Instrumentos cortantes
Strumenti taglienti

KONSERVIERENDE
ZAHNBEHANDLUNG

CONSERVATION
OF TEETH

DENTISTERIE
CONSERVATRICE

ODONTOLOGÍA
CONSERVADORA

ODONTOLOGIA
CONSERVATIVA



Fig. 65/66



Fig. 69/70



Fig. 73/74



Fig. 75/76



Fig. 77/78



Fig. 79/80



BLACK

83-4902-65

83-4902-69

83-4902-73

83-4902-75

83-4902-77

83-4902-79

ZEPF[®]
INSTRUMENTS

83-4902-79

83.41

Schneidende Instrumente
Cutting Instruments
Instruments tranchants
Instrumentos cortantes
Strumenti taglienti

KONSERVIERENDE
ZAHNBEHANDLUNG

CONSERVATION
OF TEETH

DENTISTERIE
CONSERVATRICE

ODONTOLOGÍA
CONSERVADORA

ODONTOLOGIA
CONSERVATIVA

Abziehstein
Sharpening Stone
Pierre à affûter
Piedra de afilar
Pietra per affilatura



BLACK
83-4902-89
Discoid Cleoid



Fig. 26



Fig. 27



Fig. 28



Fig. 29

BLACK

83-4904-26

83-4904-27

83-4904-28

83-4904-29



83-4909-11
110 x 4 - 14 x 6 mm



83-4902-89

83.42

Wurzelkanal Stopfer
 Root Canal Pluggers
 Fouloirs à canaux
 Obturadores radiculares
 Pluggers per canali

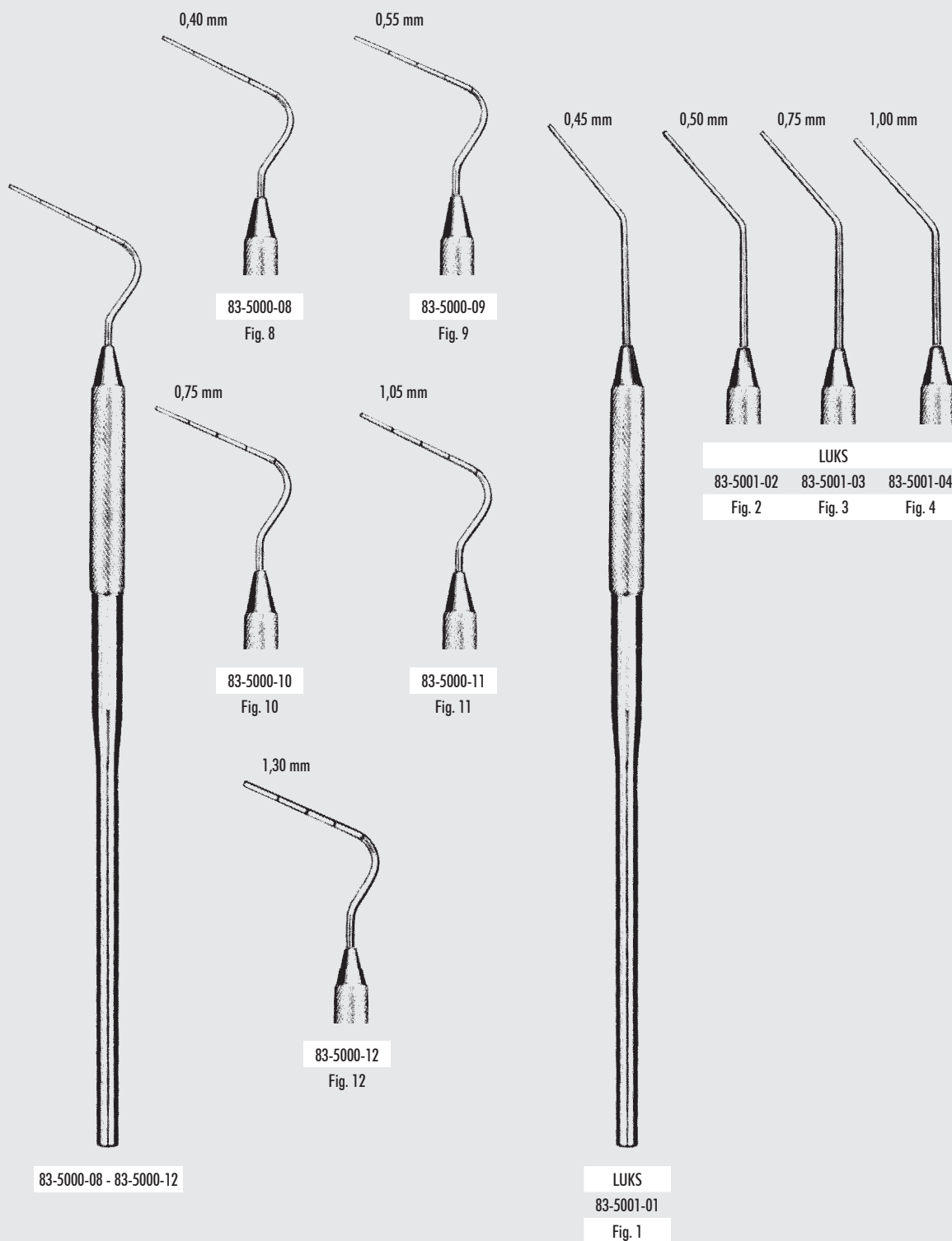

KONSERVIERENDE
 ZAHNBEHANDLUNG

CONSERVATION
 OF TEETH

DENTISTERIE
 CONSERVATRICE

ODONTOLOGÍA
 CONSERVADORA

ODONTOLOGIA
 CONSERVATIVA

ZEPF[®]
α
 INSTRUMENTS

83-5001-04

83.43

Wurzelkanal-Spreizer, -Stopfer
 Root Canal Spreaders, Root Canal Pluggers
 Fouloirs latéraux, Fouloirs à canaux
 Condensadores laterales, Obturadores radiculares
 Spreaders per trattamenti canalari, Pluggers per canali

0,35 mm

0,25 mm

0,25 mm

0,25 mm



83-5002-00
Fig. 3



83-5002-01
Fig. GP1



83-5002-02
Fig. GP2



83-5002-03
Fig. GP3

0,30 mm



83-5002-25
Fig. 1S

0,40 mm



83-5002-40
Fig. 2S

0,40 mm



83-5002-60
Fig. D11

0,20 mm

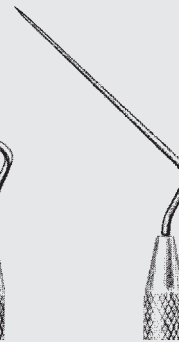

83-5003-03
Fig. MA57

0,35 mm

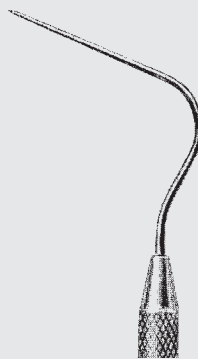

83-5003-10
Fig. 0

0,55 mm



83-5003-20
Fig. 00

ENDODONTIE
INSTRUMENTE

ENDODONTIC
INSTRUMENTS

INSTRUMENTS
ENDODONTIQUES

INSTRUMENTOS
ENDODÓNTICOS

STRUMENTI
ENDODONTICI



83-5002-00

83.44

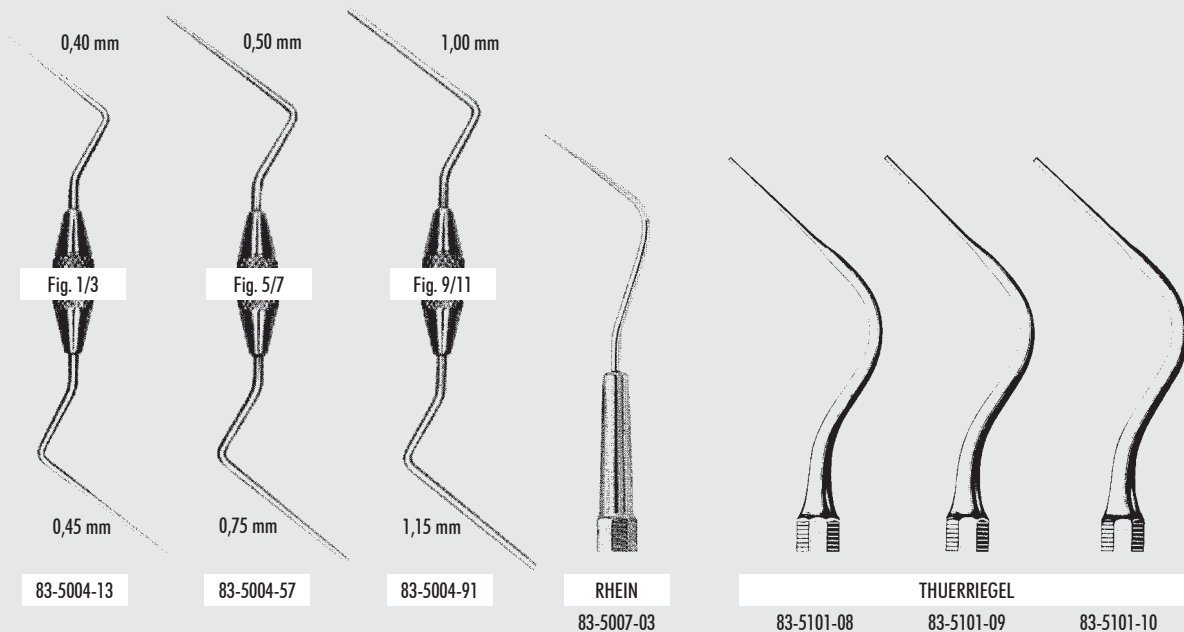

Wurzelkanal-Stopfer
 Root Canal Pluggers
 Fouloirs à canaux
 Obturadores radiculares
 Pluggers per canali

ENDODONTIE
 INSTRUMENTE

ENDODONTIC
 INSTRUMENTS

INSTRUMENTS
 ENDODONTIQUES

INSTRUMENTOS
 ENDODÓNTICOS

STRUMENTI
 ENDODONTICI

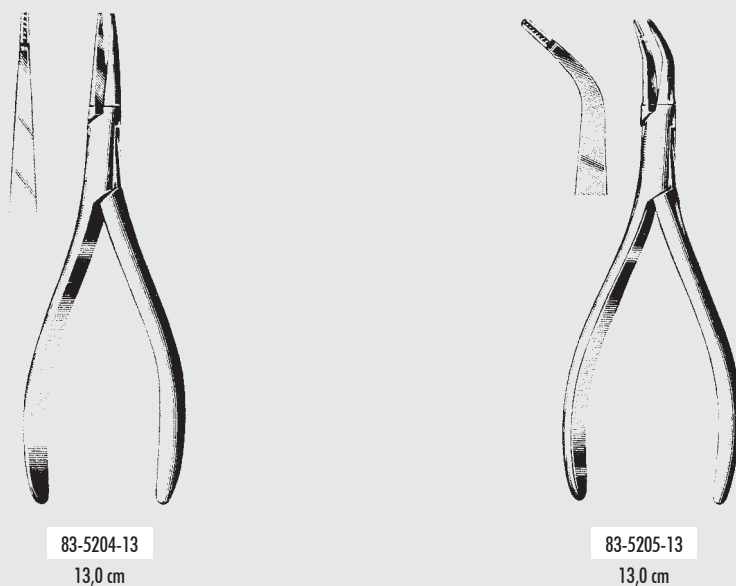

Zangen zum Herausholen abgebrochener Nervnadeln
 Pliers for Removing Broken Broaches
 Pinces pour retirer les tire-nerfs cassés
 Pinzas para extraer tira-nervios rotos
 Pinze per estrarre tiranervi rotti

ZEPF[®]
α
 INSTRUMENTS

83-5205-13

83.45



DIAGNOSTIK

DIAGNOSTICS

DIAGNOSTIC

DIAGNÓSTICO

DIAGNOSTICA



83-1100-12

83.46

DIAGNOSTIK

DIAGNOSTICS

DIAGNOSTIC

DIAGNÓSTICO

DIAGNOSTICA





DIAGNOSTIK

DIAGNOSTICS

DIAGNOSTIC

DIAGNÓSTICO

DIAGNOSTICA



KONSERVIERENDE ZAHNBEHANDLUNG

CONSERVATIVE TREATMENT

DENTISTERIE CONSERVATRICE

ODONTOLOGÍA CONSERVADORA

ODONTOIATRIA CONSERVATIVA

Finierfeilen
 Finishing Files
 Limes à finir les aurifications
 Limas para acabar orificaciones
 Lime parodontali

KONSERVIERENDE
 ZAHNBEHANDLUNG

CONSERVATIVE
 TREATMENT

DENTISTERIE
 CONSERVATRICE

ODONTOLOGÍA
 CONSERVADORA

ODONTOIATRIA
 CONSERVATIVA

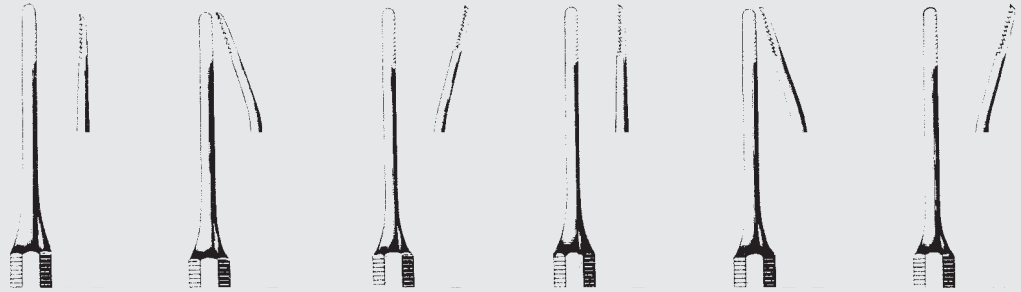

WEDELSTAEDT					
84-1200-01	84-1200-02	84-1200-03	84-1200-04	84-1200-05	84-1200-06
Fig. 1	Fig. 2	Fig. 3	Fig. 4	Fig. 5	Fig. 6

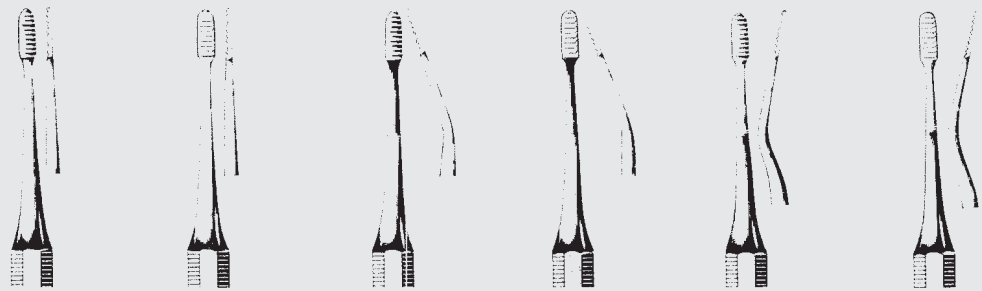

BLACK					
84-1203-01	84-1203-02	84-1203-03	84-1203-04	84-1203-05	84-1203-06
Fig. 1	Fig. 2	Fig. 3	Fig. 4	Fig. 5	Fig. 6

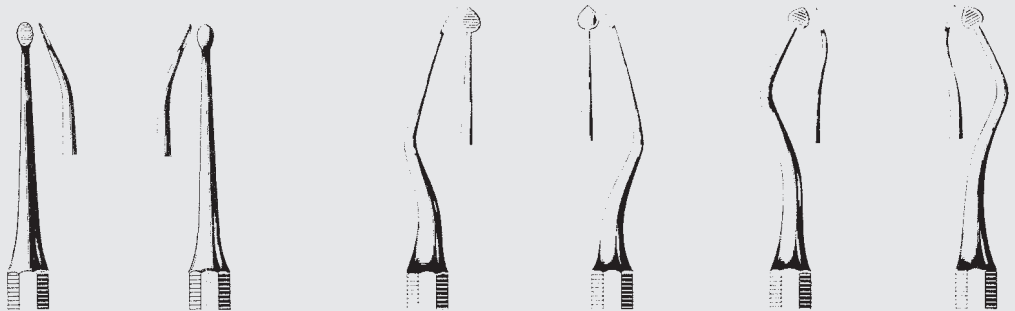

RHEIN		TOMPKINS			
84-1203-31	84-1203-32	84-1209-01	84-1209-02	84-1209-03	84-1209-04
Fig. 31	Fig. 32	Fig. 1	Fig. 2	Fig. 3	Fig. 4



84-120 0-01

84.2

Amalgamstopfer, Füllungsinstrumente
Amalgam Pluggers, Filling Instruments
Fouloirs à amalgame et pour plombages
Obturadores
Otturatori

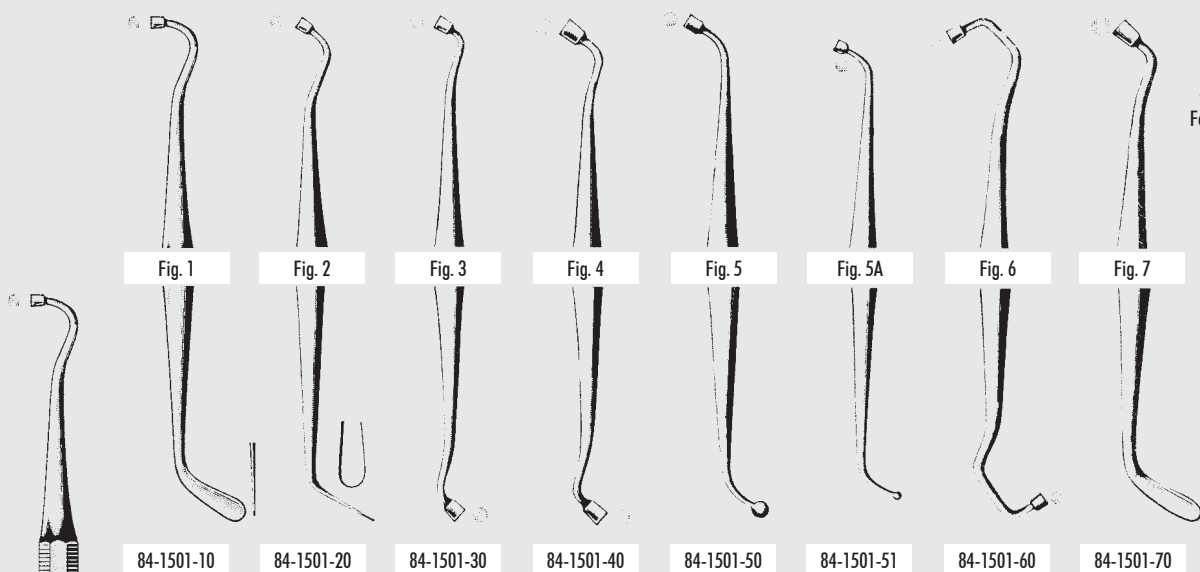

Fig. 1 Fig. 2 Fig. 3 Fig. 4 Fig. 5 Fig. 5A Fig. 6 Fig. 7

84-1501-10 84-1501-20 84-1501-30 84-1501-40 84-1501-50 84-1501-51 84-1501-60 84-1501-70

KONSERVIERENDE
ZAHNBEHANDLUNG

CONSERVATIVE
TREATMENT

DENTISTERIE
CONSERVATRICE

ODONTOLOGÍA
CONSERVADORA

ODONTOIATRIA
CONSERVATIVA

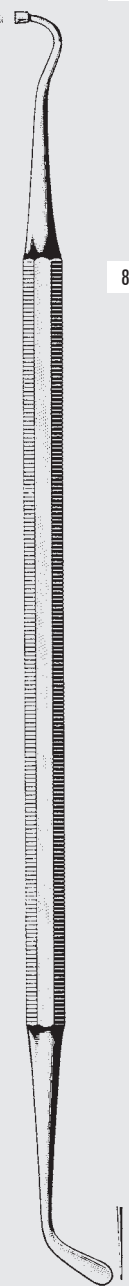

84-1501-10 - 84-1701-78

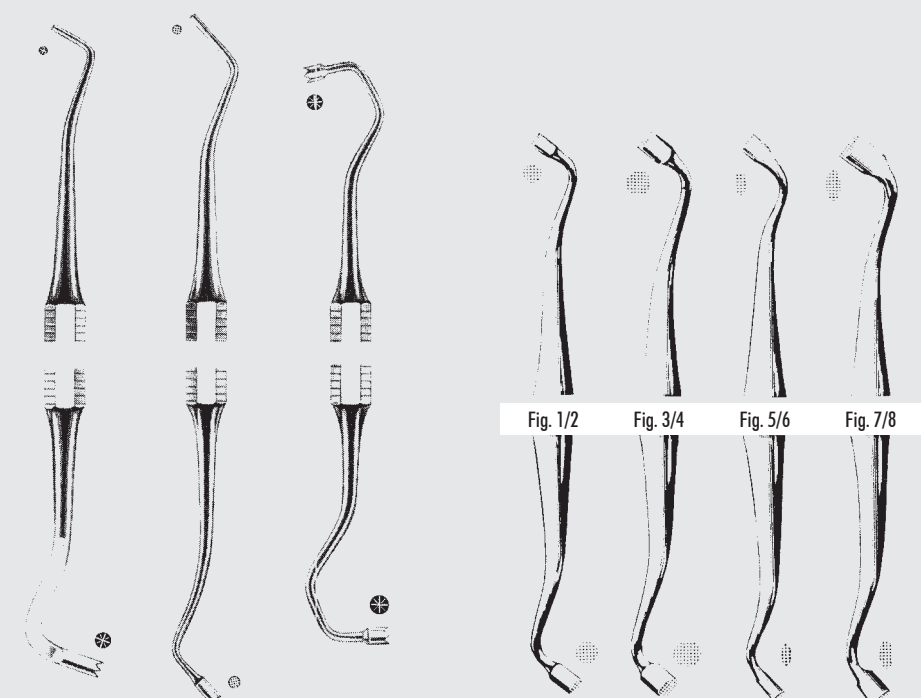

ELLIOT EAMES HOLLENBACK HAUBEIL

84-1603-00 84-1605-00 84-1607-00 84-1701-12 84-1701-34 84-1701-56 84-1701-78



84-1701-78

84.3

Amalgamstopfer
 Amalgam Pluggers
 Fouloirs à amalgame
 Obturadores para amalgama
 Otturatori per amalgama

KONSERVIERENDE
 ZAHNBEHANDLUNG

CONSERVATIVE
 TREATMENT

DENTISTERIE
 CONSERVATRICE

ODONTOLOGÍA
 CONSERVADORA

ODONTOIATRIA
 CONSERVATIVA

Polierer
 Burnishers
 Brunissoirs
 Bruñidores
 Brunitori

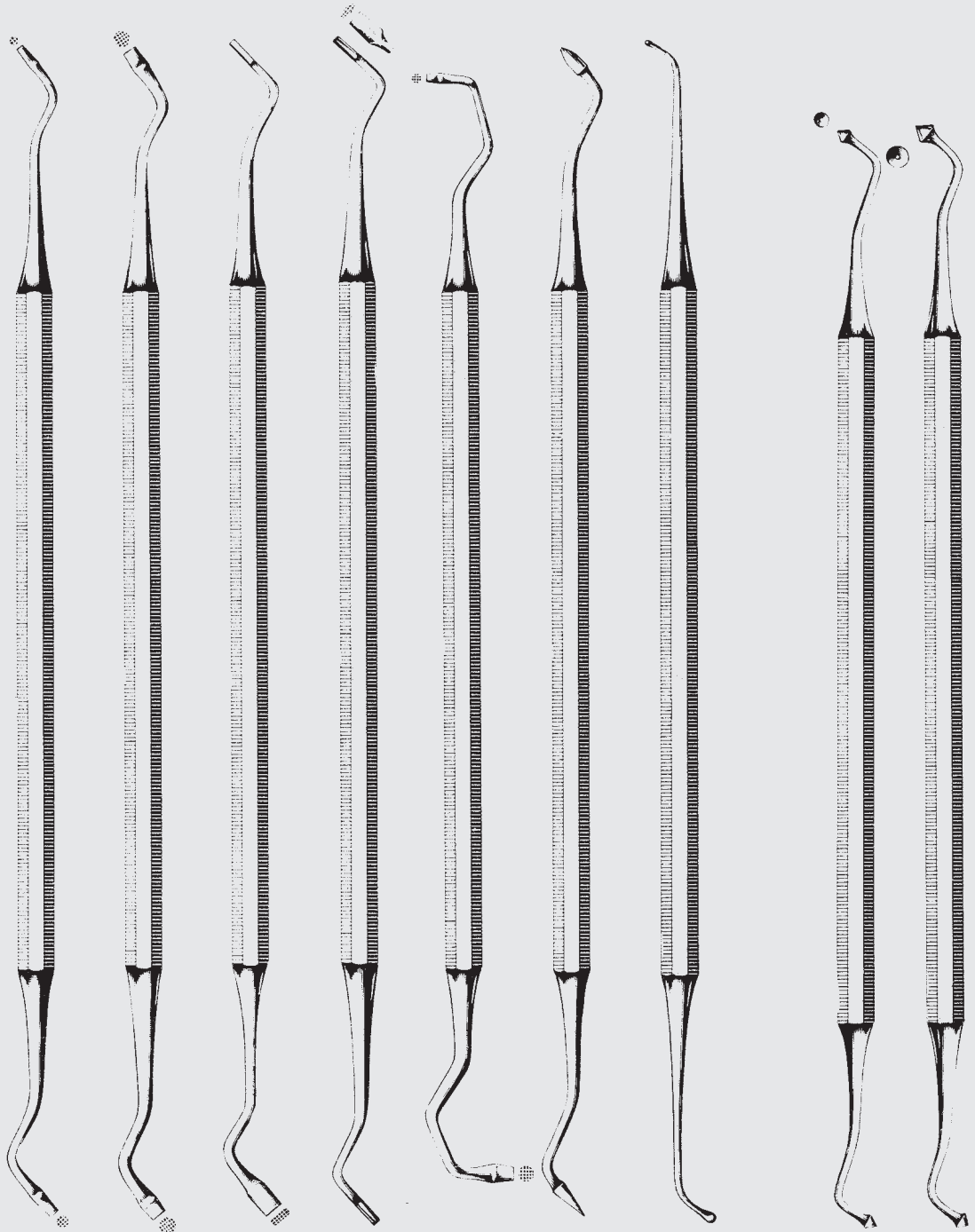

HOLLENBACK						
84-1705-01	84-1705-02	84-1705-03	84-1705-04	84-1705-05	84-1705-06	84-1705-07
Fig. 1	Fig. 2	Fig. 3	Fig. 4	Fig. 5	Fig. 6	Fig. 7

WESTCOTT	
84-1707-01	84-1707-02
Fig. 1/21	Fig. 2/21B



84-1705-01

84.4

Amalgam-Pistolen
 Amalgam Carriers
 Porte-amalgame
 Porta-amalgama
 Pistole per amalgama

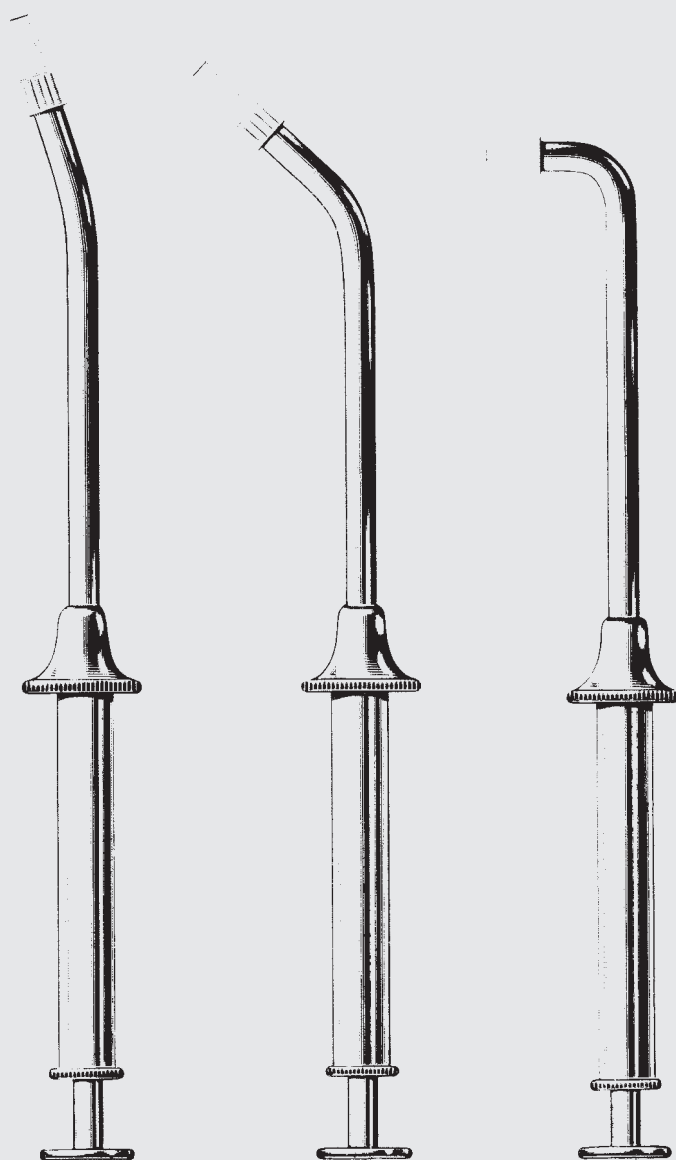

84-1809-11
 Metall · metal · métal · metal · metallo

84-1809-12
 Plastic · plastic · plastique · plástico · plastica

KONSERVIERENDE
 ZAHNBEHANDLUNG

CONSERVATIVE
 TREATMENT

DENTISTERIE
 CONSERVATRICE

ODONTOLOGÍA
 CONSERVADORA

ODONTOIATRIA
 CONSERVATIVA

84-1805-01 84-1807-01 84-1809-01
 Mit Plastikspitze · with plastic tip · à pointe en plastique · con punta de plástico · con punta in plastica

84-1805-02 84-1807-02 84-1809-02
 Mit Metallspitze · with metal tip · à pointe en métal · con punta de metal · con punta in metallo



84-1809-12

84.5

Amalgam-Träger
 Amalgam Carriers
 Porte-amalgame
 Porta-amalgama
 Spingi-amalgama

KONSERVIERENDE
 ZAHNBEHANDLUNG

CONSERVATIVE
 TREATMENT

DENTISTERIE
 CONSERVATRICE

ODONTOLOGÍA
 CONSERVADORA

ODONTOIATRIA
 CONSERVATIVA

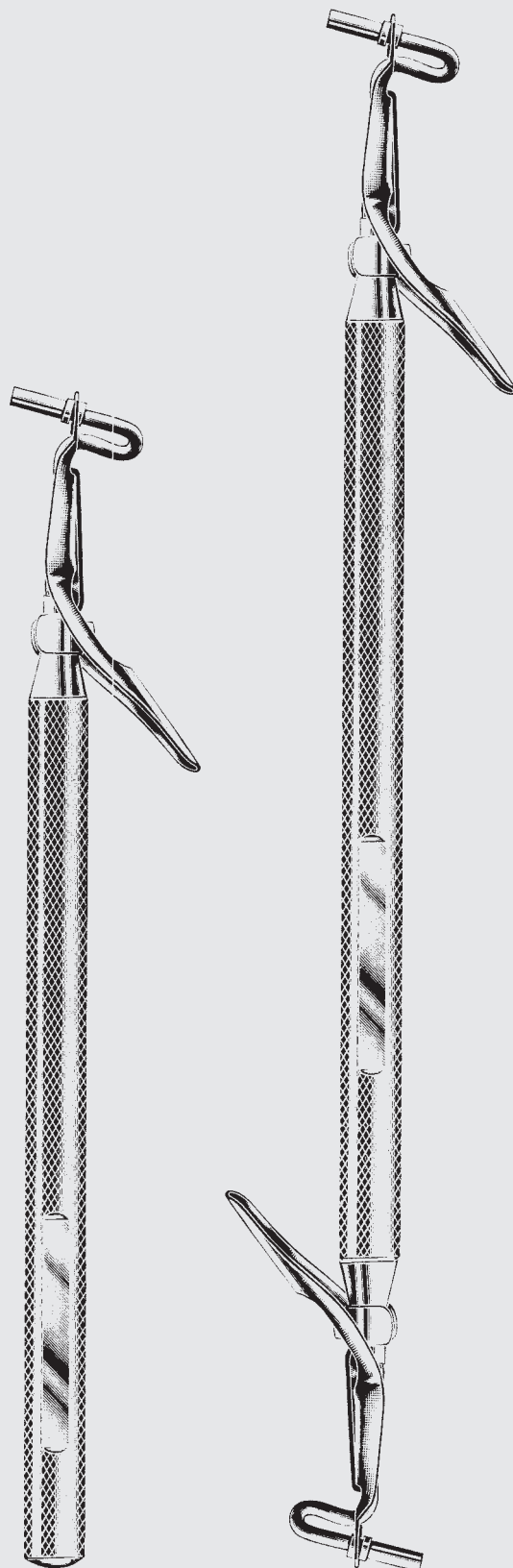

IVORY

84-2006-17

84-2006-21

ZEPF[®]
α
 INSTRUMENTS

84-2006-17

84.6

Polierer
Burnishers
Brunissoirs
Bruñidores
Brunitori

KONSERVIERENDE
ZAHNBEHANDLUNG

CONSERVATIVE
TREATMENT

DENTISTERIE
CONSERVATRICE

ODONTOLOGÍA
CONSERVADORA

ODONTOIATRIA
CONSERVATIVA



84-2301-01
Fig. 1



84-2301-02
Fig. 2



84-2301-03
Fig. 3



84-2301-05
Fig. 5



84-2301-25
Fig. 25



84-2301-26
Fig. 26



84-2301-27
Fig. 27



84-2301-28
Fig. 28



84-2301-29
Fig. 29



84-2301-31
Fig. 31



84-2301-32
Fig. 32



84-2301-33
Fig. 33



84-2301-34
Fig. 34

WHITE

84-2301-01 - 84-2301-34

ZEPF[®]
INSTRUMENTS

84-2301-34

84.7

Polierer
Burnishers
Brunissoirs
Bruñidores
Brunitori

KONSERVIERENDE
ZAHNBEHANDLUNG

CONSERVATIVE
TREATMENT

DENTISTERIE
CONSERVATRICE

ODONTOLOGÍA
CONSERVADORA

ODONTOIATRIA
CONSERVATIVA



BALL
84-2303-18
Fig. 18



84-2303-21



84-2303-22



84-2303-26



84-2303-27



84-2303-18

84.8

Instrumente für plastische Füllungen
 Plastic Filling Instruments
 Instruments pour plombages plastiques
 Instrumentos para obturaciones plásticas
 Strumenti per otturazione

KONSERVIERENDE
 ZAHNBEHANDLUNG

CONSERVATIVE
 TREATMENT

DENTISTERIE
 CONSERVATRICE

ODONTOLOGÍA
 CONSERVADORA

ODONTOIATRIA
 CONSERVATIVA

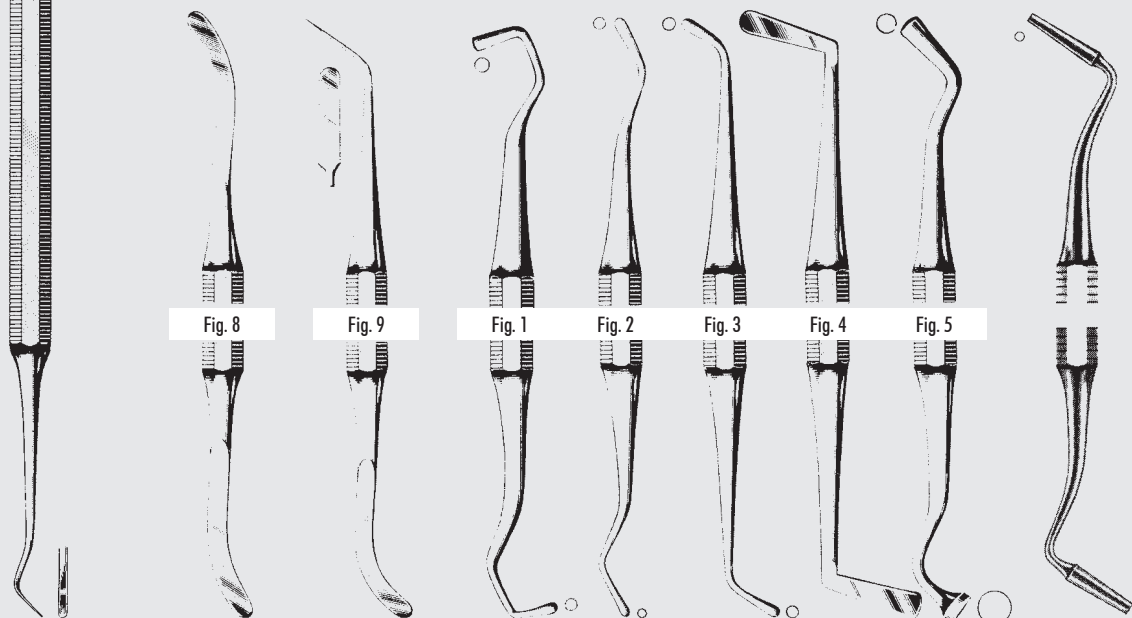
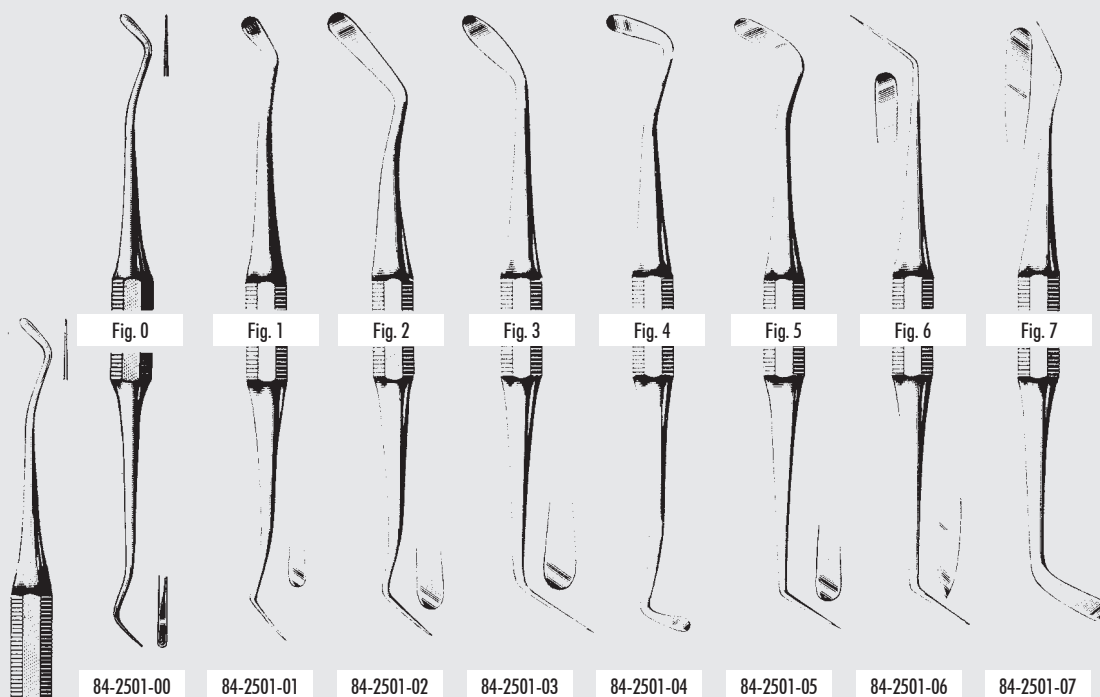

84-2501-00 - 84-2603-00

84-2501-08

84-2501-09

LADMORE
 84-2601-01 84-2601-02 84-2601-03 84-2601-04 84-2601-05

MARTONSON
 84-2603-00

ZEPF[®]
α
 INSTRUMENTS

84-2603-00

84.9

Instrumente für plastische Füllungen
 Plastic Filling Instruments
 Instruments pour plombages plastiques
 Instrumentos para obturaciones plásticas
 Strumenti per otturazione

KONSERVIERENDE
 ZAHNBEHANDLUNG

CONSERVATIVE
 TREATMENT

DENTISTERIE
 CONSERVATRICE

ODONTOLOGÍA
 CONSERVADORA

ODONTOIATRIA
 CONSERVATIVA



84-2700-10 - 84-2700-90

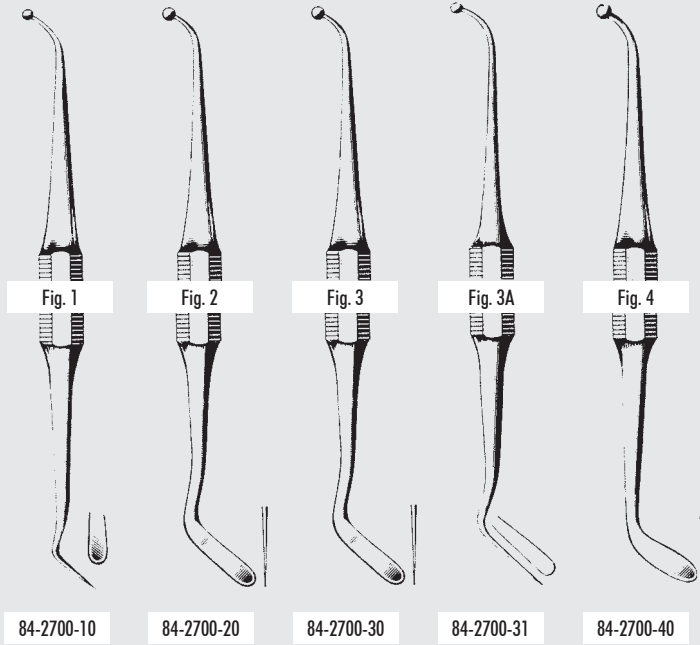

84-2700-10 84-2700-20 84-2700-30 84-2700-31 84-2700-40

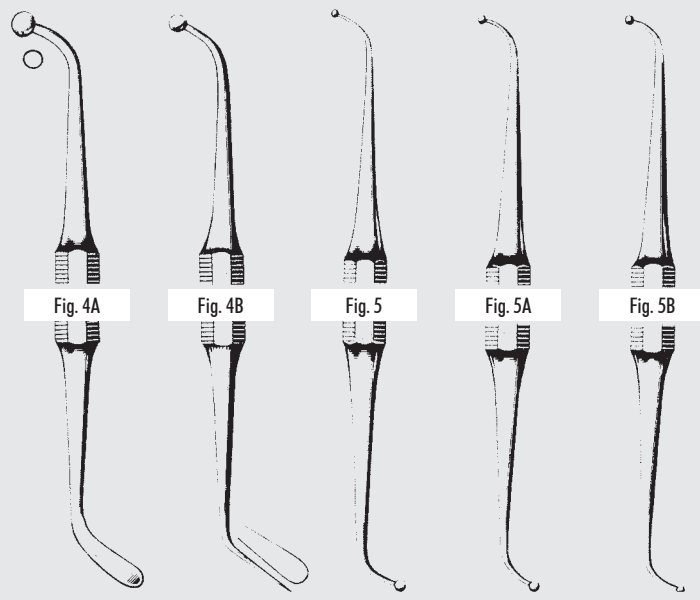

84-2700-41 84-2700-42 84-2700-50 84-2700-51 84-2700-52



84-2700-10

84.10

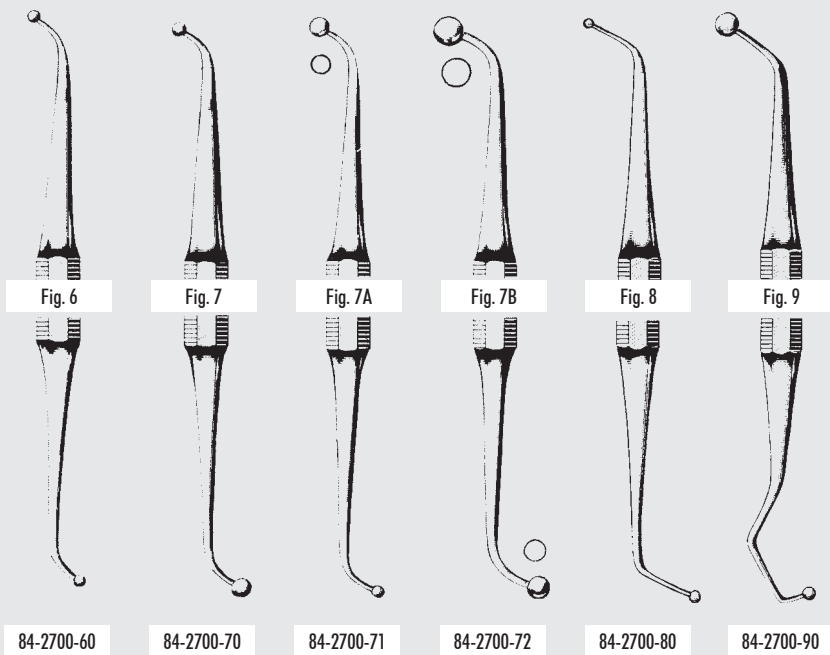

Instrumente für plastische Füllungen
 Plastic Filling Instruments
 Instruments pour plombages plastiques
 Instrumentos para obturaciones plásticas
 Strumenti per otturazione

KONSERVIERENDE
 ZAHNBEHANDLUNG

CONSERVATIVE
 TREATMENT

DENTISTERIE
 CONSERVATRICE

ODONTOLOGÍA
 CONSERVADORA

ODONTOIATRIA
 CONSERVATIVA



84-2701-20
 Fig. 20

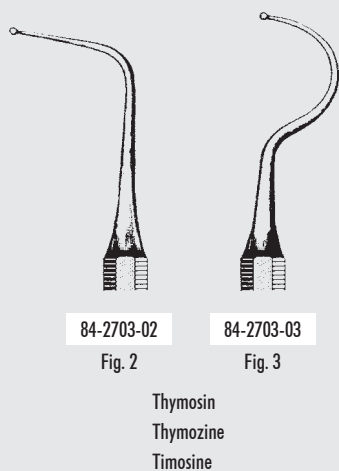

Thymosin
 Thymozine
 Timosine

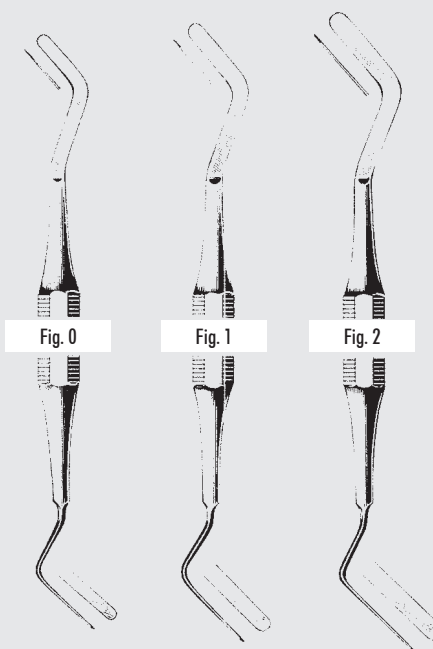

HEIDEMANN		
84-2707-00	84-2707-01	84-2707-02
mit Achtkantgriff - with octagonal handles - à manches octogonales - con mangos octogonales - con manici ottagonali		
84-2709-00	84-2709-01	84-2709-02
mit Rundgriff - with round handles - à manches rondes - con mangos redondos - con manici rotondi		
2,0 mm	2,5 mm	3,0 mm



84-2707-02

84.11

Instrumente für plastische Füllungen
 Plastic Filling Instruments
 Instruments pour plombages plastiques
 Instrumentos para obturaciones plásticas
 Strumenti per otturazione

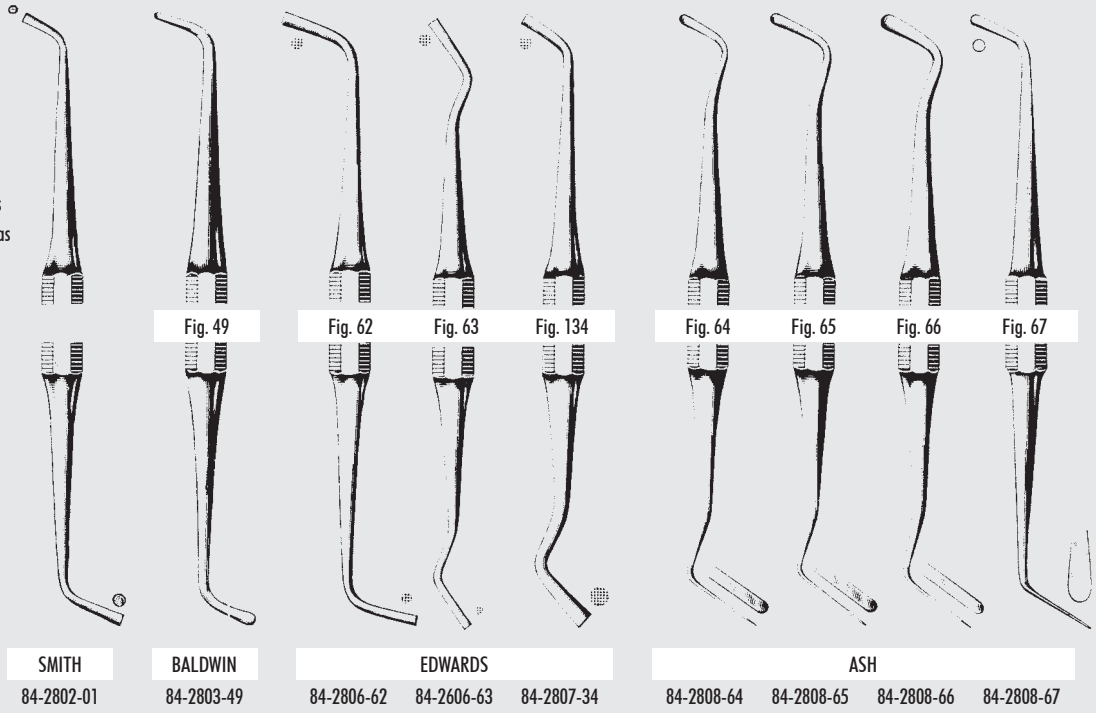

KONSERVIERENDE
 ZAHNBEHANDLUNG

CONSERVATIVE
 TREATMENT

DENTISTERIE
 CONSERVATRICE

ODONTOLOGÍA
 CONSERVADORA

ODONTOIATRIA
 CONSERVATIVA

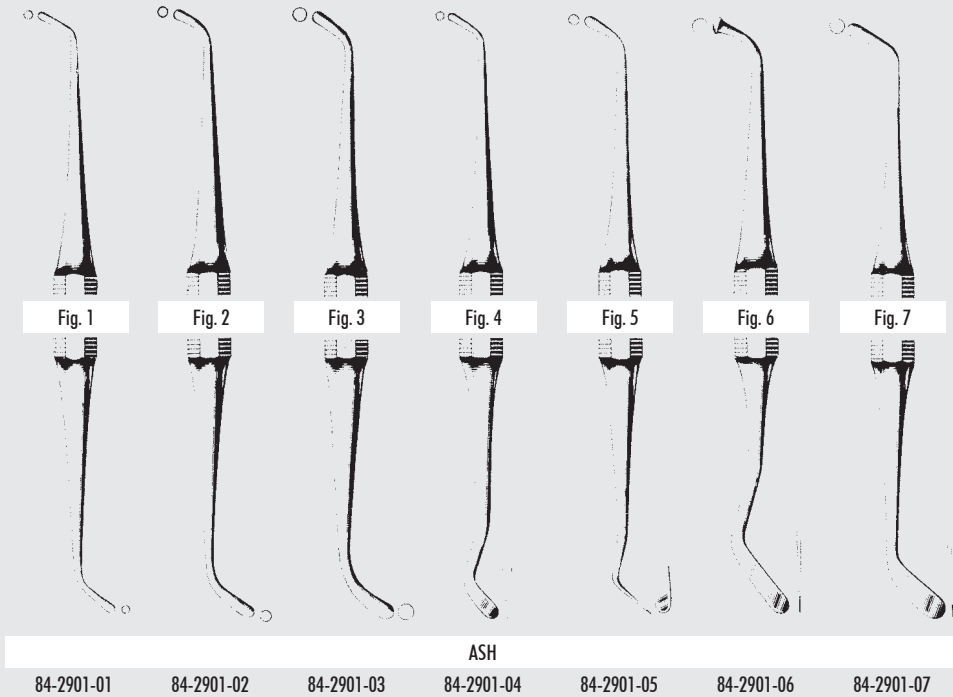

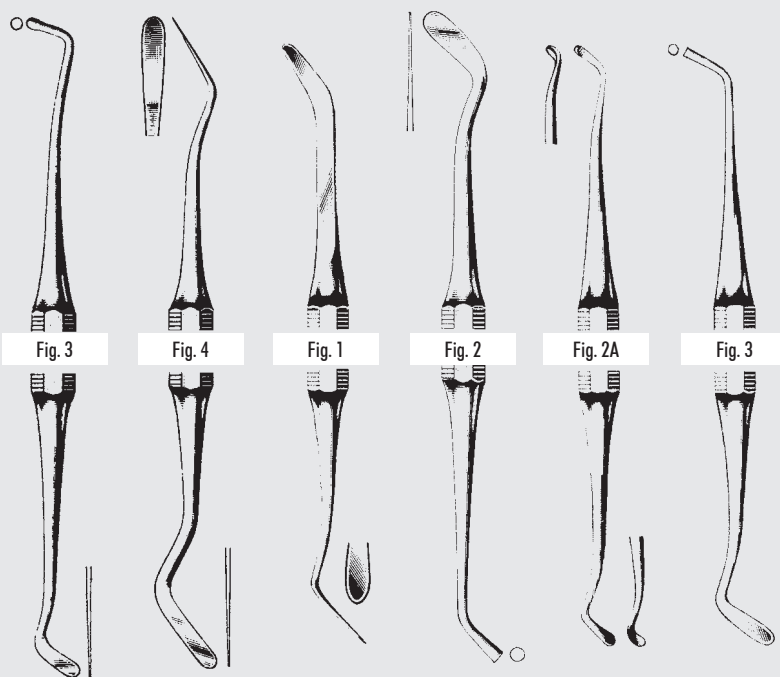

Fig. 3

Fig. 4

Fig. 1

Fig. 2

Fig. 2A

Fig. 3

WHITE

84-3001-03

84-3001-04

84-3005-10

84-3005-20

84-3005-21

84-3005-30

Instrumente für plastische Füllungen
 Plastic Filling Instruments
 Instruments pour plombages plastiques
 Instrumentos para obturaciones plásticas
 Strumenti per otturazione

KONSERVIERENDE
 ZAHNBEHANDLUNG

CONSERVATIVE
 TREATMENT

DENTISTERIE
 CONSERVATRICE

ODONTOLOGÍA
 CONSERVADORA

ODONTOIATRIA
 CONSERVATIVA

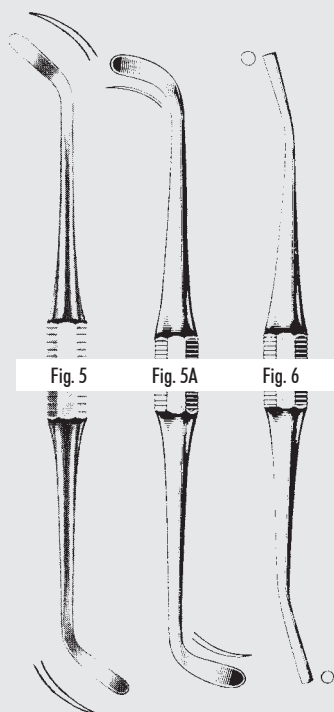

Fig. 5

Fig. 5A

Fig. 6

WHITE

84-3005-50

84-3005-51

84-3005-60

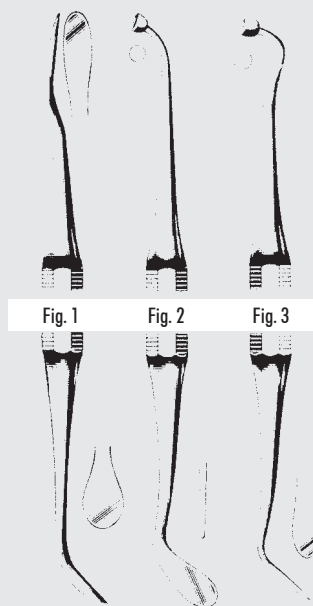

Fig. 1

Fig. 2

Fig. 3

WOODSON

84-3101-01

84-3101-02

84-3101-03

ZEPF[®]
α
 INSTRUMENTS

84-3101-03

84.13

Instrumente für plastische Füllungen
 Plastic Filling Instruments
 Instruments pour plombages plastiques
 Instrumentos para obturaciones plásticas
 Strumenti per otturazione

KONSERVIERENDE
 ZAHNBEHANDLUNG

CONSERVATIVE
 TREATMENT

DENTISTERIE
 CONSERVATRICE

ODONTOLOGÍA
 CONSERVADORA

ODONTOIATRIA
 CONSERVATIVA

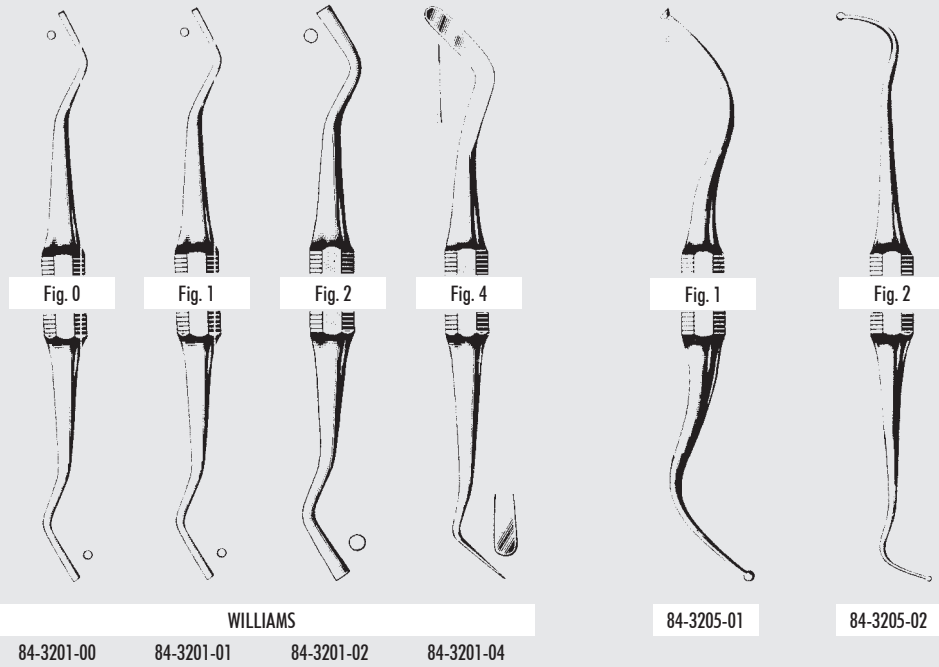

84-3201-00

84-3201-01

84-3201-02

84-3201-04

84-3205-01

84-3205-02

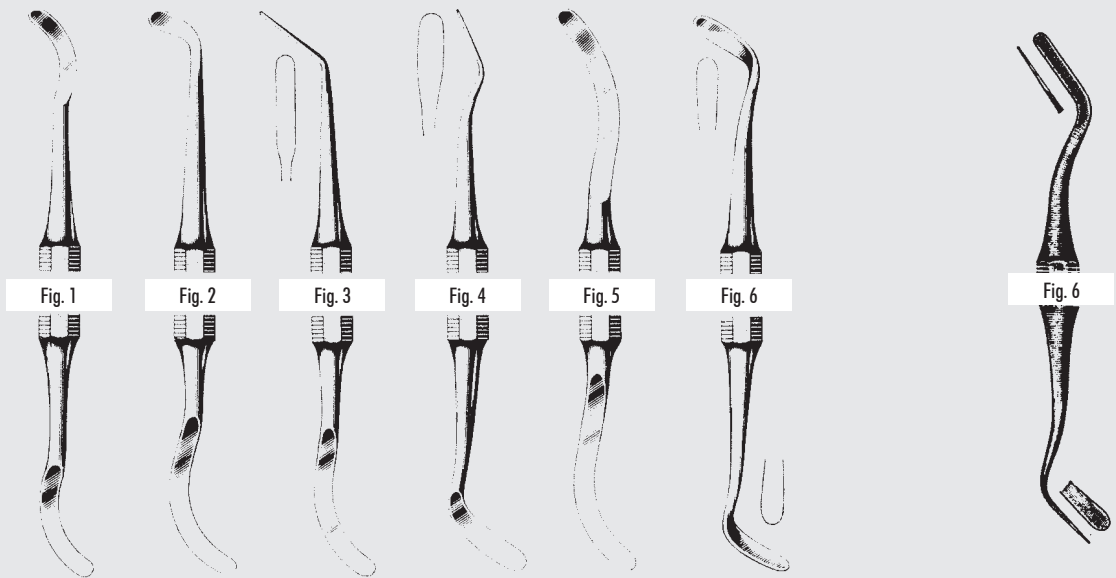

Fig. 1

Fig. 2

Fig. 3

Fig. 4

Fig. 5

Fig. 6

Fig. 6

LINSEMANN

84-3401-01

84-3401-02

84-3401-03

84-3401-04

84-3401-05

84-3401-06

ASH

84-3402-06
(LSP6)



84-3201-00

84.14

Instrumente für plastische Füllungen
 Plastic Filling Instruments
 Instruments pour plombages plastiques
 Instrumentos para obturaciones plásticas
 Strumenti per otturazione

KONSERVIERENDE
 ZAHNBEHANDLUNG

CONSERVATIVE
 TREATMENT

DENTISTERIE
 CONSERVATRICE

ODONTOLOGÍA
 CONSERVADORA

ODONTOIATRIA
 CONSERVATIVA

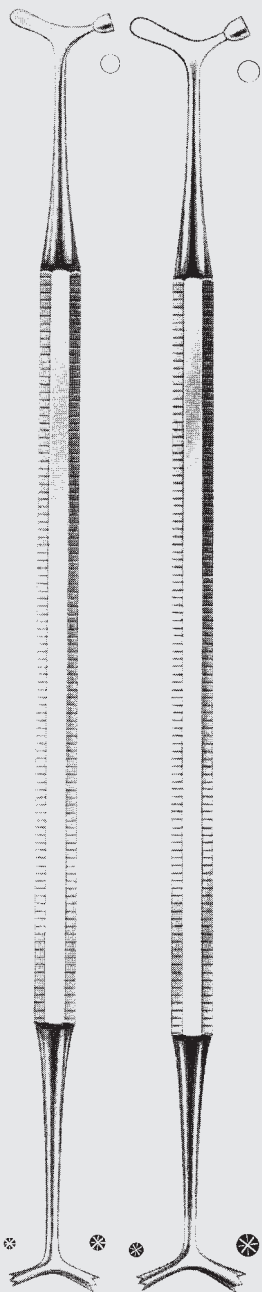

BENNET
 84-3409-07 84-3409-10
 Fig. 7 Fig. 10

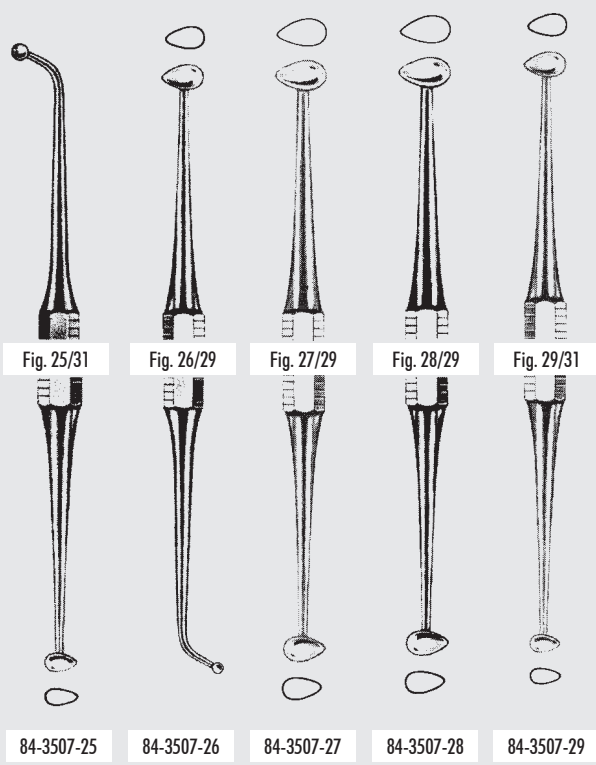

84-3507-25 84-3507-26 84-3507-27 84-3507-28 84-3507-29

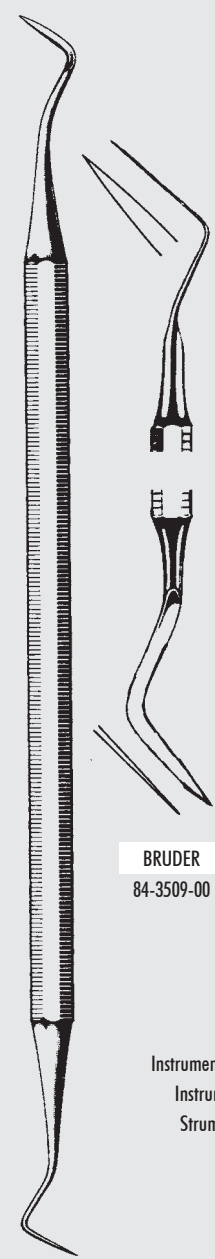

84-3508-00

BRUDER
 84-3509-00

Füllungsentferner
 Instruments for lifting temporary stoppings
 Instruments pour enlever des obturations temporaires
 Instrumentos para quitar obturaciones temporales
 Strumenti per estrazione di otturazioni temporali



84-3509-00
 84.15

Instrumente für plastische Füllungen
Plastic Filling Instruments
Instruments pour plombages plastiques
Instrumentos para obturaciones plásticas
Strumenti per otturazione

Kontra-Satz DIN 13 978 Jan. 1972

KONSERVIERENDE
ZAHNBEHANDLUNG

CONSERVATIVE
TREATMENT

DENTISTERIE
CONSERVATRICE

ODONTOLOGÍA
CONSERVADORA

ODONTOIATRIA
CONSERVATIVA

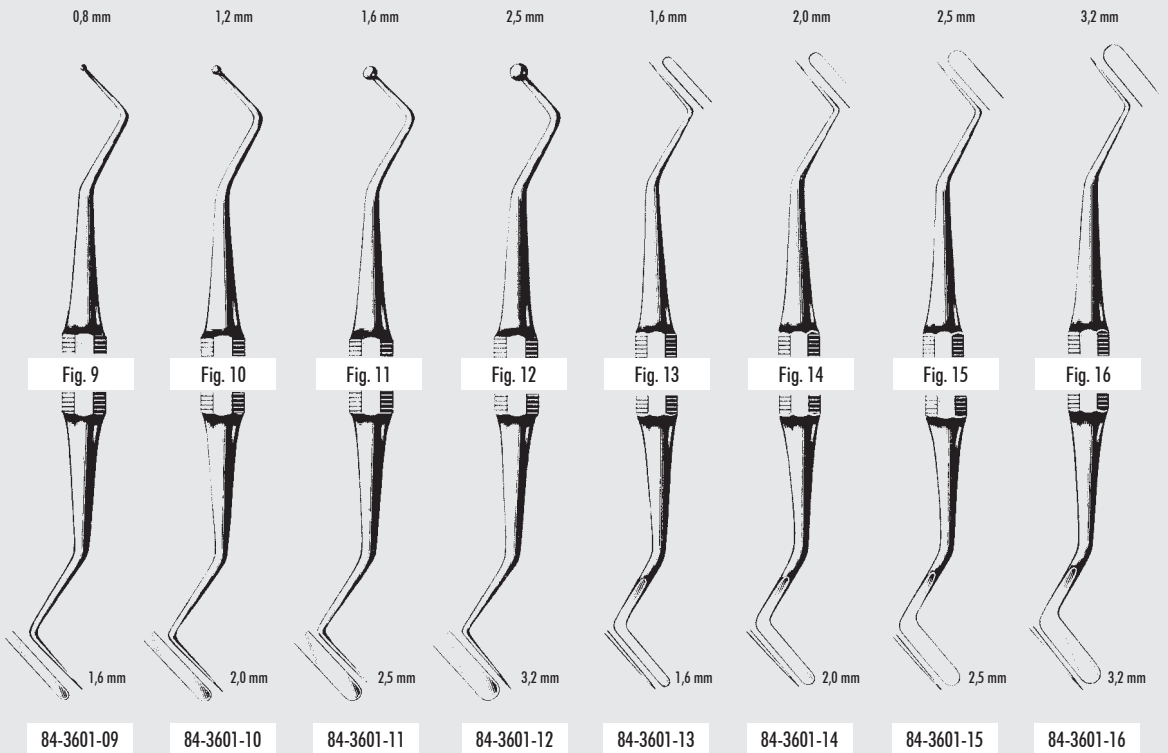
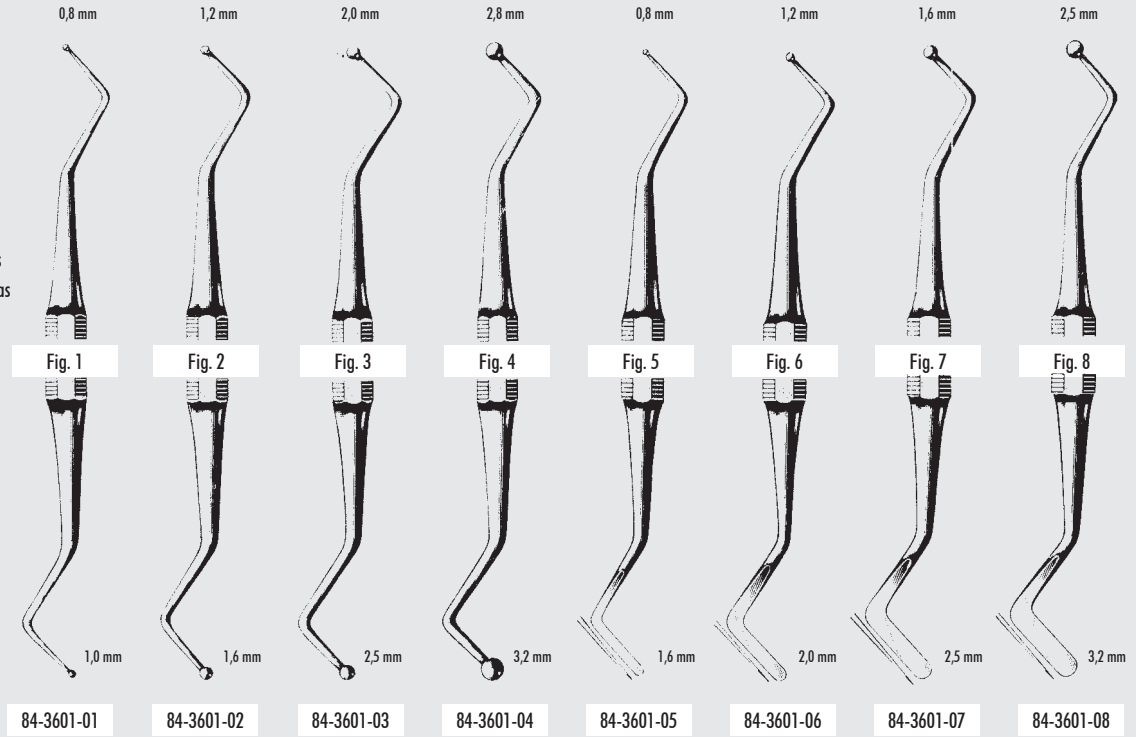

84-3601-01

84.16

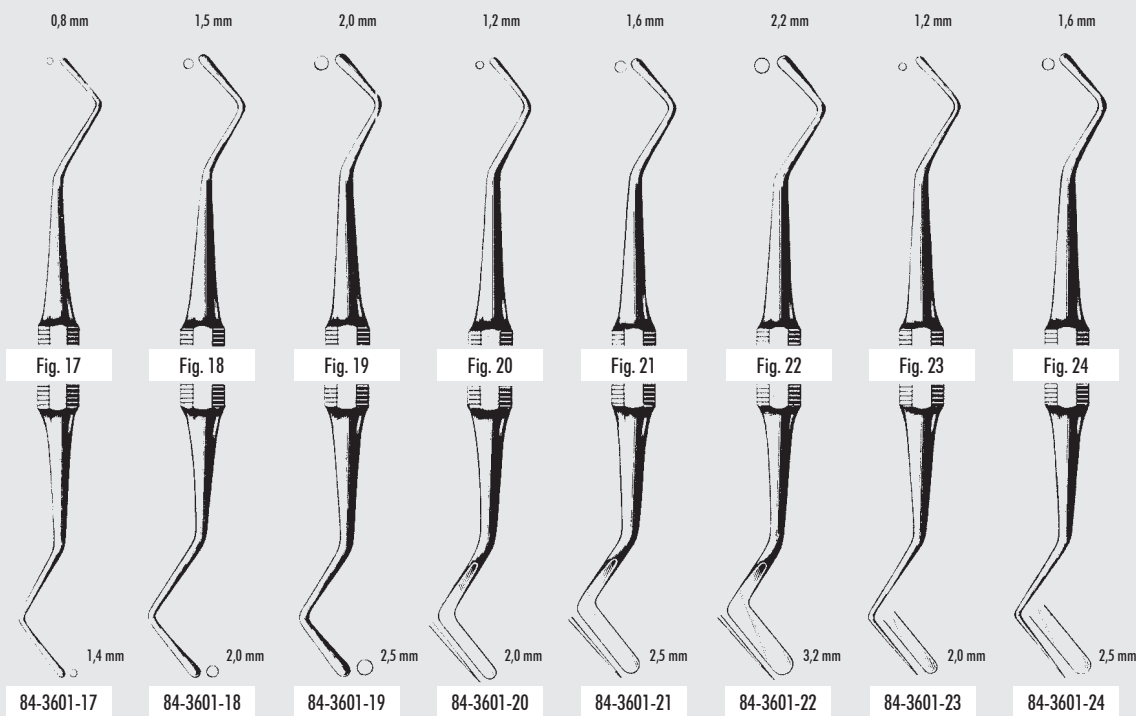

Instrumente für plastische Füllungen
 Plastic Filling Instruments
 Instruments pour plombages plastiques
 Instrumentos para obturaciones plásticas
 Strumenti per otturazione

Kontra-Satz DIN 13 978 Jan. 1972

KONSERVIERENDE
 ZAHNBEHANDLUNG

CONSERVATIVE
 TREATMENT

DENTISTERIE
 CONSERVATRICE

ODONTOLOGÍA
 CONSERVADORA

ODONTOIATRIA
 CONSERVATIVA

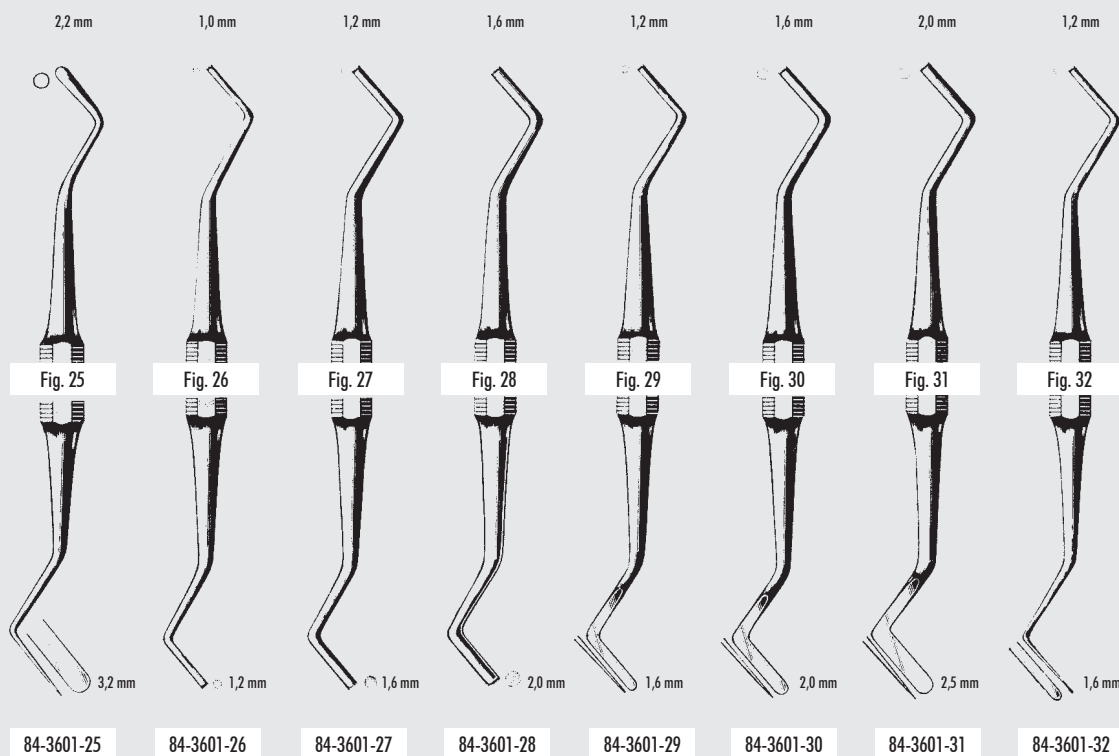

ZEPF[®]
INSTRUMENTS

84-3601-32

84.17

Instrumente für plastische Füllungen
 Plastic Filling Instruments
 Instruments pour plombages plastiques
 Instrumentos para obturaciones plásticas
 Strumenti per otturazione

Kontra-Satz DIN 13 978 Jan. 1972

**KONSERVIERENDE
 ZAHNBEHANDLUNG**

**CONSERVATIVE
 TREATMENT**

**DENTISTERIE
 CONSERVATRICE**

**ODONTOLOGÍA
 CONSERVADORA**

**ODONTOIATRIA
 CONSERVATIVA**

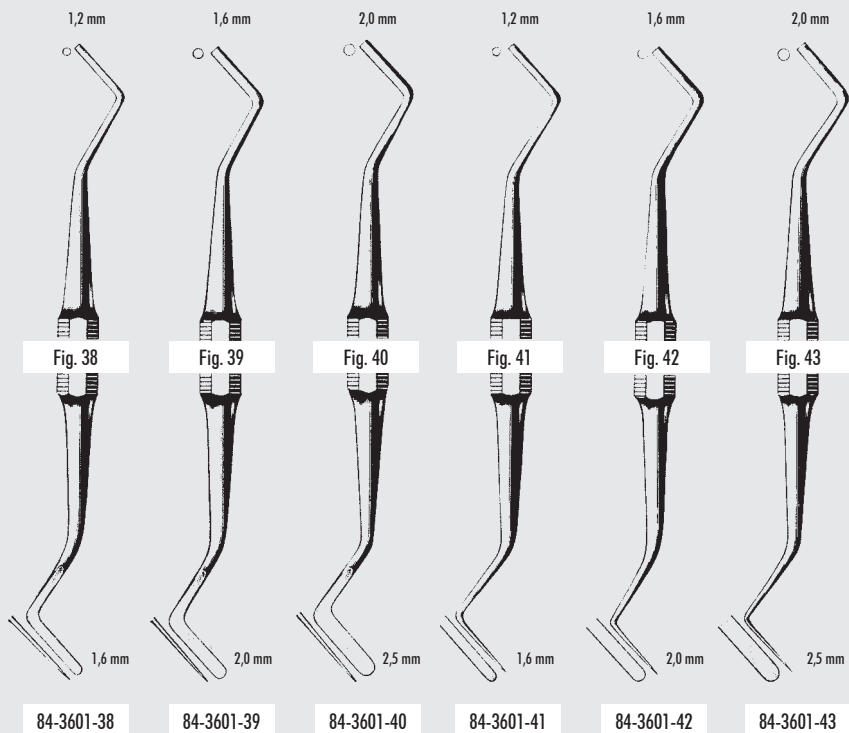
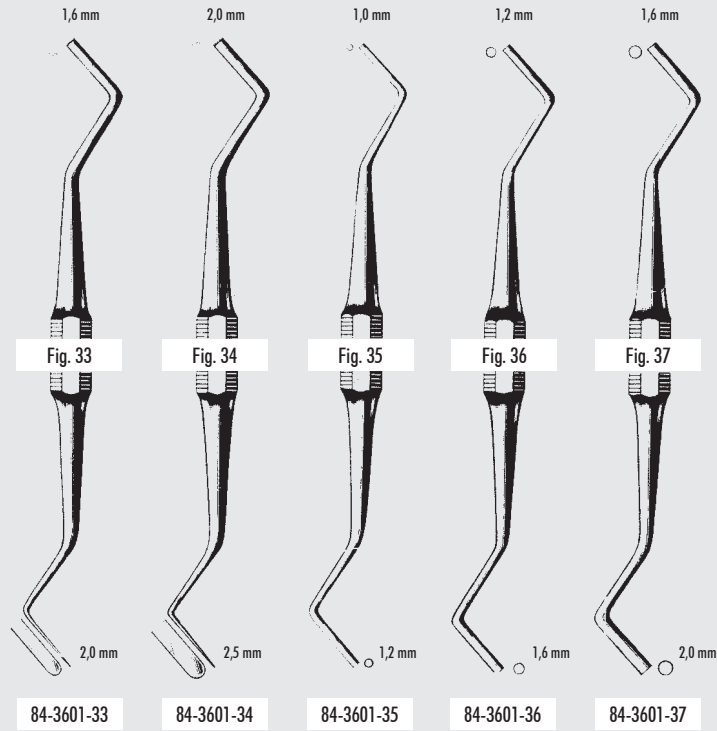

84-3601-33

84.18

Instrumente für plastische Füllungen
 Plastic Filling Instruments
 Instruments pour plombages plastiques
 Instrumentos para obturaciones plásticas
 Strumenti per otturazione

KONSERVIERENDE
 ZAHNBEHANDLUNG

CONSERVATIVE
 TREATMENT

DENTISTERIE
 CONSERVATRICE

ODONTOLOGÍA
 CONSERVADORA

ODONTOIATRIA
 CONSERVATIVA



84-3701-01
 Fig. 1

84-3701-02
 Fig. 2

84-3701-03
 Fig. 3

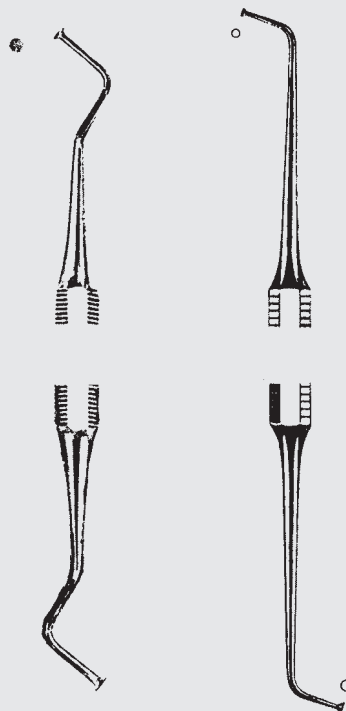

BUECHS
 84-3805-00

JOERGENSEN
 84-3807-00

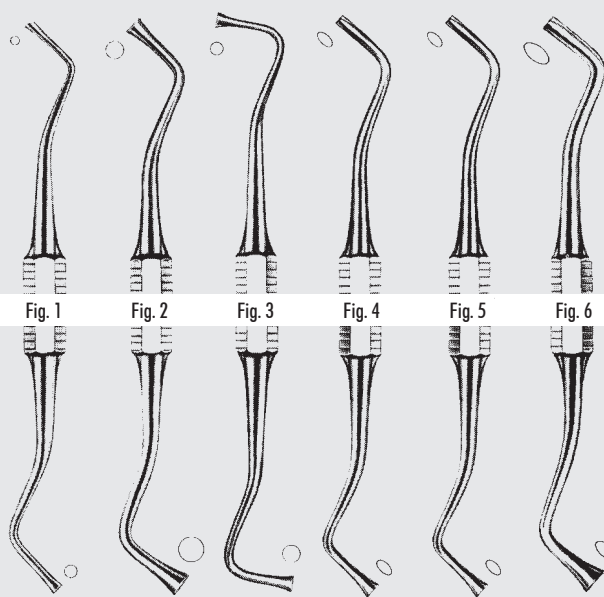

Fig. 1

Fig. 2

Fig. 3

Fig. 4

Fig. 5

Fig. 6

WARD

84-3901-01

84-3901-02

84-3901-03

84-3901-04

84-3901-05

84-3901-06

ZEPF[®]

 INSTRUMENTS

84-3901-06

84.19

Instrumente für plastische Füllungen
 Plastic Filling Instruments
 Instruments pour plombages plastiques
 Instrumentos para obturaciones plásticas
 Strumenti per otturazione

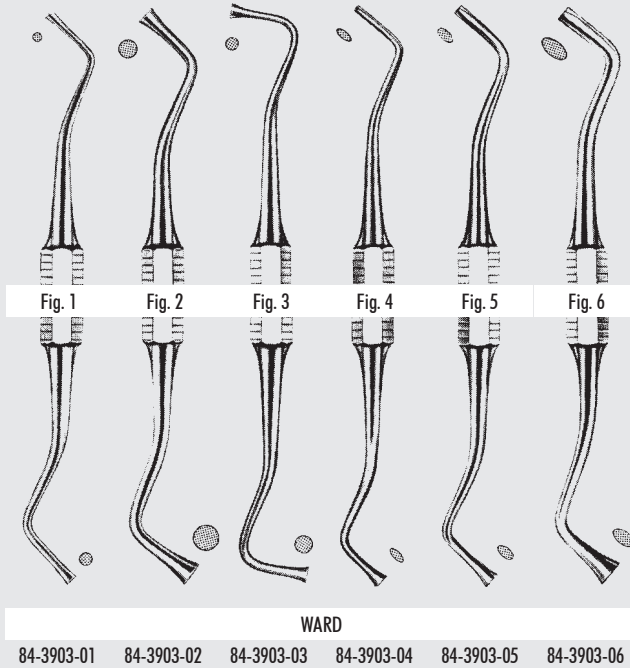

KONSERVIERENDE
 ZAHNBEHANDLUNG

CONSERVATIVE
 TREATMENT

DENTISTERIE
 CONSERVATRICE

ODONTOLOGÍA
 CONSERVADORA

ODONTOIATRIA
 CONSERVATIVA

Anrührplatten, Glas
 Mixing Slabs, Glass
 Disques à gâcher, en verre
 Placas para mezclar, de vidrio
 Piastrelle per mescolare in vetro

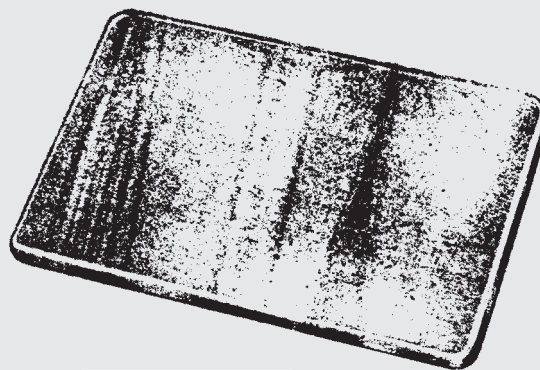

10 x 10 cm 84-4004-10
 13 x 8 cm 84-4004-13

ZEPF®

 INSTRUMENTS

84-3903-01

84.20

Zementspatel
 Cement Spatulas
 Spatules à ciment
 Espátulas para cemento
 Spatole per cemento

KONSERVIERENDE
 ZAHNBEHANDLUNG

CONSERVATIVE
 TREATMENT

DENTISTERIE
 CONSERVATRICE

ODONTOLOGÍA
 CONSERVADORA

ODONTOIATRIA
 CONSERVATIVA



84-4100-06
 Fig. 6



84-4100-07
 Fig. 7



84-4102-01
 Fig. 1



84-4102-02
 Fig. 2

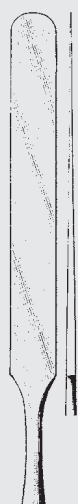

84-4102-04
 Fig. 4



84-4200-36
 Fig. 36



84-4206-01
 Fig. 1



84-4206-01

84.21

Zementspatel
 Cement Spatulas
 Spatules à ciment
 Espátulas para cemento
 Spatole per cemento

KONSERVIERENDE
 ZAHNBEHANDLUNG

CONSERVATIVE
 TREATMENT

DENTISTERIE
 CONSERVATRICE

ODONTOLOGÍA
 CONSERVADORA

ODONTOIATRIA
 CONSERVATIVA

Silikat-Spatel aus Kunststoff
 Silicate Spatula, from Plastic
 Spatule à silicate, en matière plastique
 Espátula para silicato, de plástico
 Spatola per silicato, in plastica

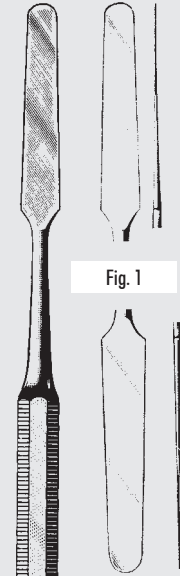

Fig. 1

84-4301-01



Fig. 2

84-4301-02



Fig. 3

84-4301-03



Fig. 1

84-4306-01



Fig. 2

84-4306-02



Fig. 3

84-4306-03



Fig. 4

84-4306-04



Fig. 5

84-4306-05



Fig. 6

84-4306-06



84-4507-01

84-4301-01 - 84-4306-06

Separator, Matrizenspanner
 Separator, Matrix Retainers
 Séparateur, Porte-matrices
 Separadores, porta-matrices
 Separatore, portamatrici

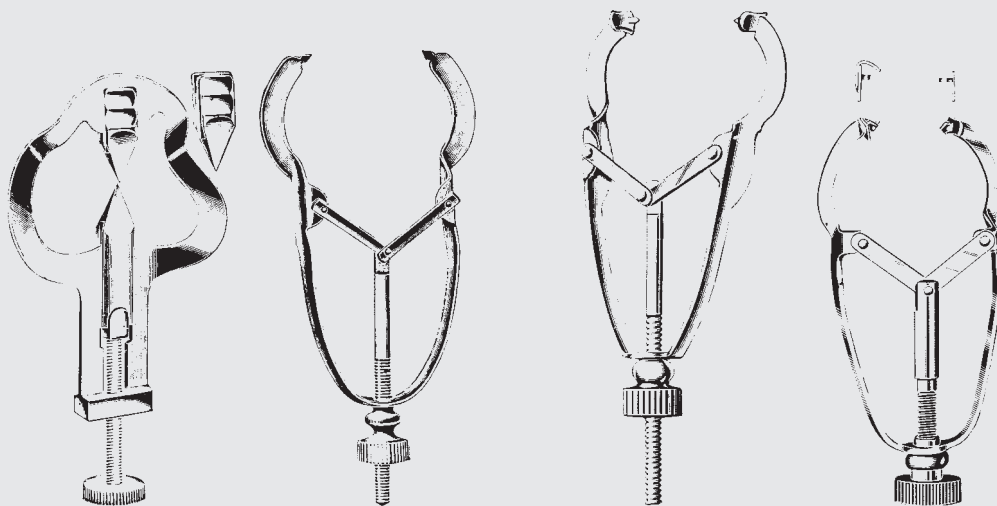

KONSERVIERENDE
 ZAHNBEHANDLUNG

CONSERVATIVE
 TREATMENT

DENTISTERIE
 CONSERVATRICE

ODONTOLOGÍA
 CONSERVADORA

ODONTOIATRIA
 CONSERVATIVA

IVORY

84-4600-01

Fig. 14

84-4605-01

Fig. 1

84-4607-01

Fig. 12

84-4608-01

Fig. 12A

Für Molaren
 For Molars
 Pour Molaïres
 Para Molares
 Per Molari

Für Prämolaren
 For Premolars
 Pour Prémolaires
 Para Premolares
 Per Premolari



84-4700-01

Fig. 1



84-4700-02

Fig. 2



84-4700-03

Fig. 3



84-4700-04

Fig. 4



84-4700-05

Fig. 5



84-4700-06

Fig. 6

Matrizen
 Matrices
 Matrices
 Matrices
 Matrici

ZEPF[®]
α
 INSTRUMENTS

84-4700-06

84.23

Matrizenspanner
Matrix Retainers
Porte-matrices
Portamatrices
Portamatrici

KONSERVIERENDE
ZAHNBEHANDLUNG

CONSERVATIVE
TREATMENT

DENTISTERIE
CONSERVATRICE

ODONTOLOGÍA
CONSERVADORA

ODONTOIATRIA
CONSERVATIVA

Matrizenspanner
Matrix Retainers
Porte-matrices
Portamatrices
Portamatrici

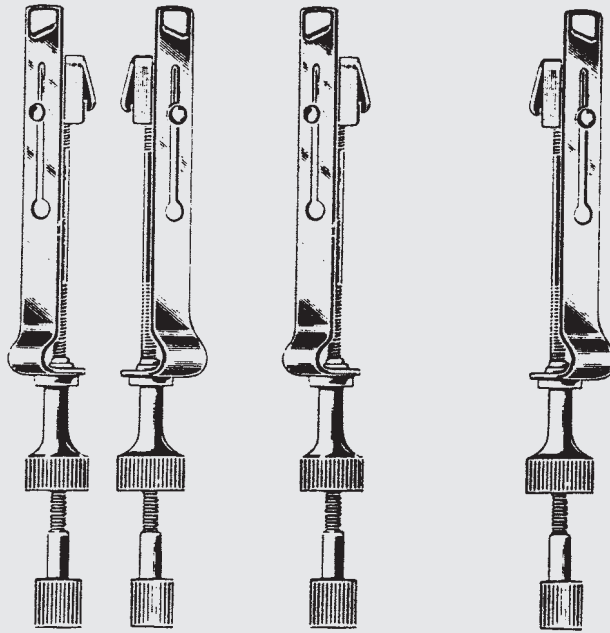

NYSTROEM

84-4704-00	84-4704-01	84-4704-02
Paar · Pair · Paire	links · left · à gauche	rechts · right · à droite
Pareja · Coppia	izquierdo · sinistro	derecho · destro

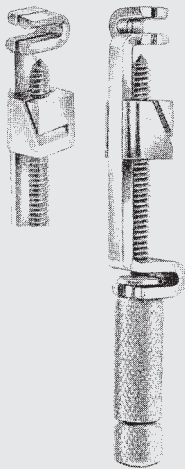

TOFFLEMIRE
84-4707-01
Universal

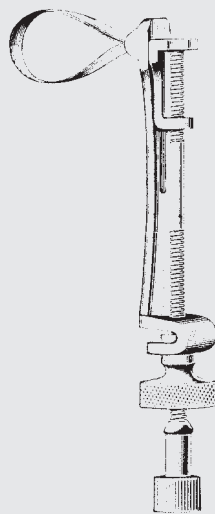

IVORY
84-4800-05 5 mm
84-4800-06 6 mm
84-4800-07 7 mm
Fig. 8

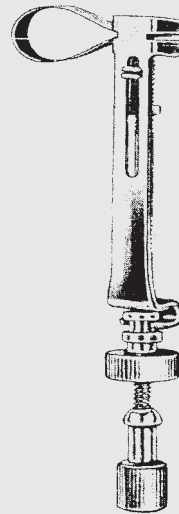

IVORY
84-4801-05
Fig. 8N

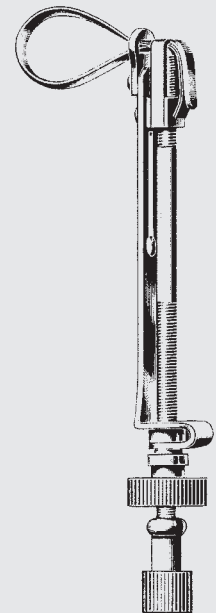

DIDNER
84-4803-05
Fig. 8P



TOFFLEMIRE
84-4802-01
Fig. 1



TOFFLEMIRE
84-4802-02
Fig. 2



TOFFLEMIRE
84-4802-03
Fig. 3



TOFFLEMIRE
84-4802-13
Fig. 13

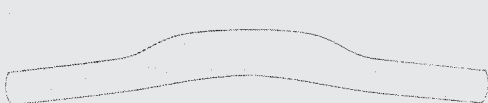

84-4804-07
Fig. 7

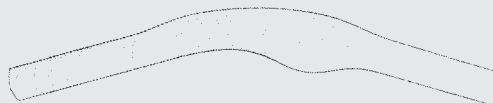

84-4804-08
Fig. 8

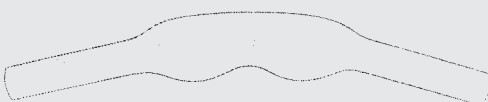

84-4804-09
Fig. 9

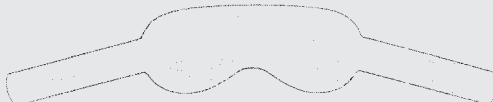

84-4804-10
Fig. 10



84-4804-11
Fig. 11



84-4804-12
Fig. 12



84-4804-13
Fig. 13



- 84-4805-05 5 mm
- 84-4805-06 6 mm
- 84-4805-07 7 mm

Matrizen, Matrizenband
Matrixes, Matrix Bands
Matrices, Rubans à matrices
Matrices, Bandas matrices
Matrici, Banda per matrici

KONSERVIERENDE
ZAHNBEHANDLUNG

CONSERVATIVE
TREATMENT

DENTISTERIE
CONSERVATRICE

ODONTOLOGÍA
CONSERVADORA

ODONTOIATRIA
CONSERVATIVA

ZEPF[®]
α
INSTRUMENTS

84-4805-07

84.25

Kofferdam-Lochzangen
 Rubber Dam Punches
 Perforateurs à digue
 Perforadores de dique
 Pinze foradiga

**KONSERVIERENDE
 ZAHNBEHANDLUNG**

**CONSERVATIVE
 TREATMENT**

**DENTISTERIE
 CONSERVATRICE**

**ODONTOLOGÍA
 CONSERVADORA**

**ODONTOIATRIA
 CONSERVATIVA**

Kofferdam-Klammerzangen
 Rubber Dam Clamp Forceps
 Pincas porte-crampons à digue
 Pinzas porta-clamps para dique
 Pinze per uncini

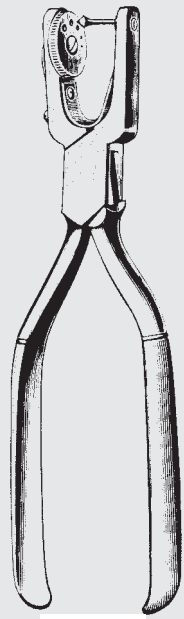

AINSWORTH
 84-5000-16

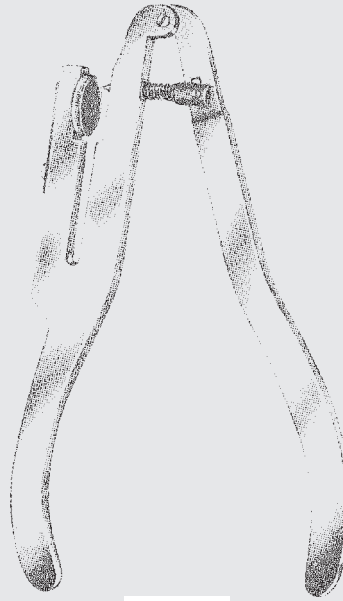

IVORY
 84-5002-15

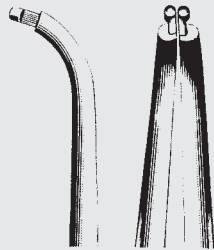

STOCKES
 84-5003-17

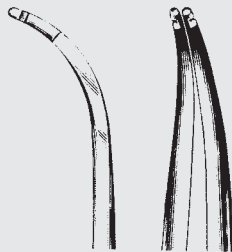
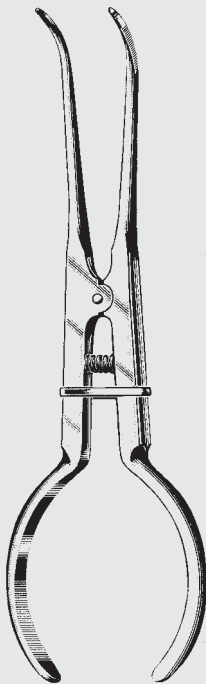

PALMER
 84-5005-17

84-5003-17 - 84-5005-17

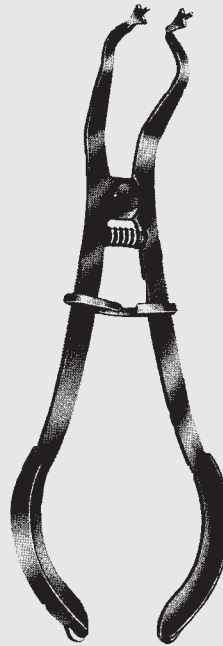

IVORY
 84-5006-16

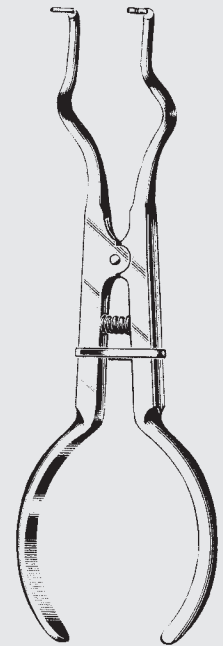

BREWER
 84-5103-17

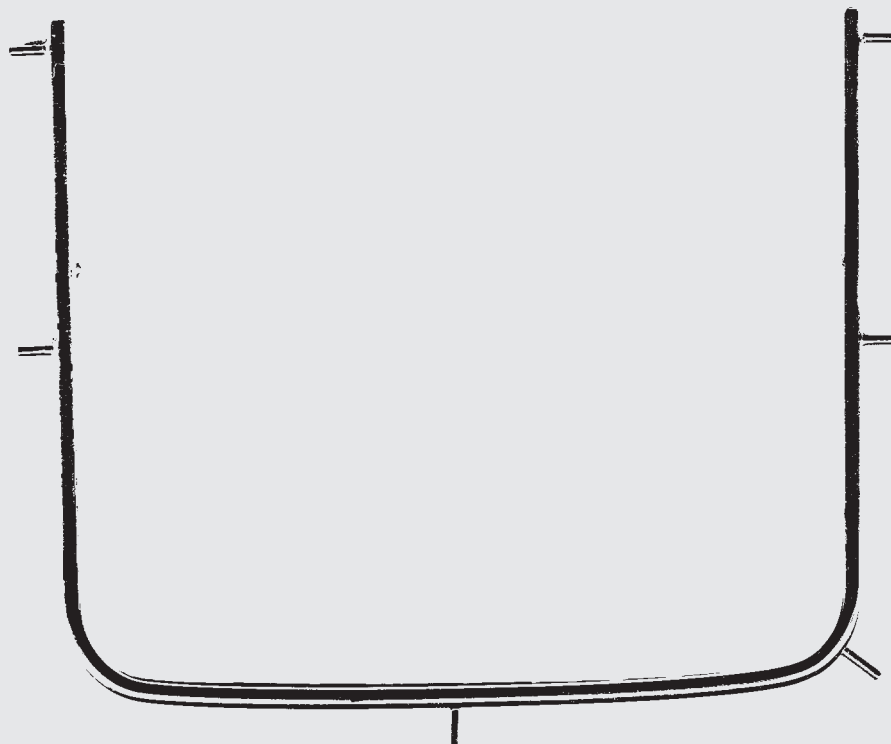

84-5104-00

Kofferdam-Halter
 Rubber Dam Holder
 Porte-digues
 Sostenedor de dique
 Supporto per Kofferdam

KONSERVIERENDE
 ZAHNBEHANDLUNG

CONSERVATIVE
 TREATMENT

DENTISTERIE
 CONSERVATRICE

ODONTOLOGÍA
 CONSERVADORA

ODONTOIATRIA
 CONSERVATIVA



84-5105-26
 Fig. 26



84-5105-27
 Fig. 27



84-5105-28
 Fig. 28



84-5105-29
 Fig. 29

IVORY



84-5105-30
 Fig. 30



84-5105-31
 Fig. 31



84-5105-51
 Fig. 51



84-5105-60
 Fig. 60

IVORY

Kofferdam-Klammern
 Rubber Dam Clamps
 Crampons pour digue en caoutchouc
 Clamps para dique
 Uncini per Kofferdam

ZEPF[®]
INSTRUMENTS

84-5105-60

84.27

KONSERVIERENDE
ZAHNBEHANDLUNG

CONSERVATIVE
TREATMENT

DENTISTERIE
CONSERVATRICE

ODONTOLOGÍA
CONSERVADORA

ODONTOIATRIA
CONSERVATIVA

PROTHETIK, ORTHODONTIE
PROSTHETICS, ORTHODONTICS
PROTHÈSE, ORTHODONTIE
PRÓTESIS, ORTODONCIA
PROTESI, ORTODONZIA

Abdrucklöffel
 Impression Trays
 Porte-empreintes
 Cubetas de impresión
 Portaimpronte

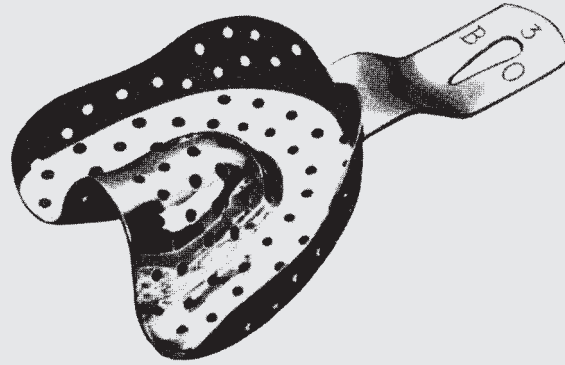

EHRICKE BO (SUP/B)				
86-1001-00	86-1001-01	86-1001-02	86-1001-03	86-1001-04
BO 0	BO 1	BO 2	BO 3	BO 4

PROTHETIK,
 ORTHODONTIE

PROSTHETICS,
 ORTHODONTICS

PROTHÈSE,
 ORTHODONTIE

PRÓTESIS,
 ORTODONCIA

PROTESI,
 ORTODONZIA



EHRICKE PO (SUP/P)		
86-1002-01	86-1002-02	86-1002-03
PO 1	PO 2	PO 3



EHRICKE (SUP/F)		
86-1003-01	86-1003-02	86-1003-03
FO 1	FO 2	FO 3



EHRICKE (SUP/U)		
86-1004-01	86-1004-02	86-1004-03
UO 1	UO 2	UO 3



EHRICKE (INF/B)				
86-1006-00	86-1006-01	86-1006-02	86-1006-03	86-1006-04
BU 0	BU 1	BU 2	BU 3	BU 4



EHRICKE (INF/P)		
86-1007-01	86-1007-02	86-1007-03
PU 1	PU 2	PU 3



EHRICKE INF/U			
86-1008-01	86-1008-02	86-1008-03	86-1008-04
UU 1	UU 2	UU 3	UU 4

Abdrucklöffel
Impression Trays
Porte-empreintes
Cubetas de impresión
Portaimpronte

PROTHETIK,
ORTHODONTIE

PROSTHETICS,
ORTHODONTICS

PROTHÈSE,
ORTHODONTIE

PRÓTESIS,
ORTODONCIA



86-1501-01	86-1501-02	86-1501-03	86-1501-04
Fig. 1	Fig. 2	Fig. 3	Fig. 4

Oberkiefer rechts / Unterkiefer links
Upper jaw right / Lower jaw left
Mâchoires supérieures de droite / Mâchoires inférieures de gauche
Mandíbulas superiores de la derecha / Mandíbulas inferiores de la izquierda
Mascella superiore destra / Mascella inferiore sinistra

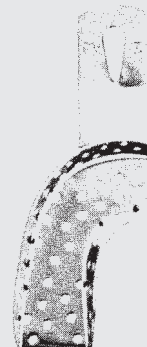

86-1601-01	86-1601-02	86-1601-03	86-1601-04
Fig. 1	Fig. 2	Fig. 3	Fig. 4

Oberkiefer links / Unterkiefer rechts
Upper jaw left / Lower jaw right
Mâchoires supérieures de gauche / Mâchoires inférieures de droite
Mandíbulas superiores de la izquierda / Mandíbulas inferiores de la derecha
Mascella superiore sinistra / Mascella inferiore destra

PROTESI,
ORTODONZIA

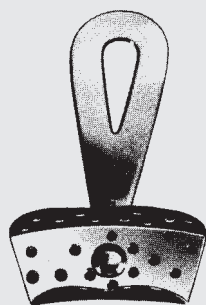

86-1701-01
Universal

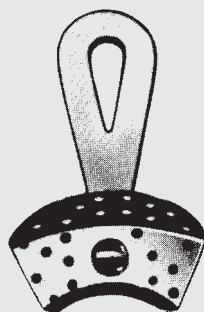

86-1705-01

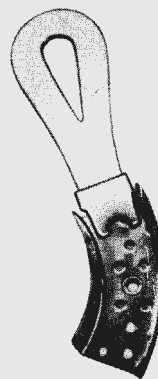

STOLLEY
86-1801-01

Für partielle Abdrücke
For Partial Impressions
Pour des impressions partielles
Para impresiones parciales
Per impronti parziali

ZEPF[®]
α
INSTRUMENTS

86-1801-01

86.3

Spatel
Spatulas
Spatules
Espátulas
Spatole

PROTHETIK,
ORTHODONTIE

PROSTHETICS,
ORTHODONTICS

PROTHÈSE,
ORTHODONTIE

PRÓTESIS,
ORTODONCIA

PROTESI,
ORTODONZIA

Spatel, Mixbecher
Spatulas, Mixing Bowl
Spatules, Cupule à mélanger
Espátulas, Taza para mezclar
Spatole, Tazza per mescolare



SCHWARZ
86-2800-17



MAYER
86-2803-19

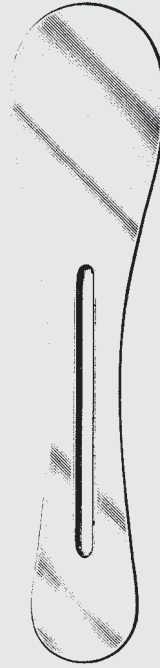

LICHTENSTEIN
86-2808-17



86-2812-19



GRITMAN
86-2900-16



86-2902-17

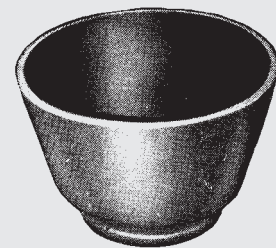

86-3200-13
ø 130 mm

Aus Weichgummi
From soft rubber
En caoutchouc souple
De cauco blando
In gomma sottile

Wachs-, Porzellan- und Modellierinstrumente
 Wax, Porcelain, and Modelling Carvers
 Instruments et spatules à cire, à porcelaine et à modeler
 Talladores y espátulas para cera, porcelana y para modelar
 Strumenti per cera, porcellana e per modellare

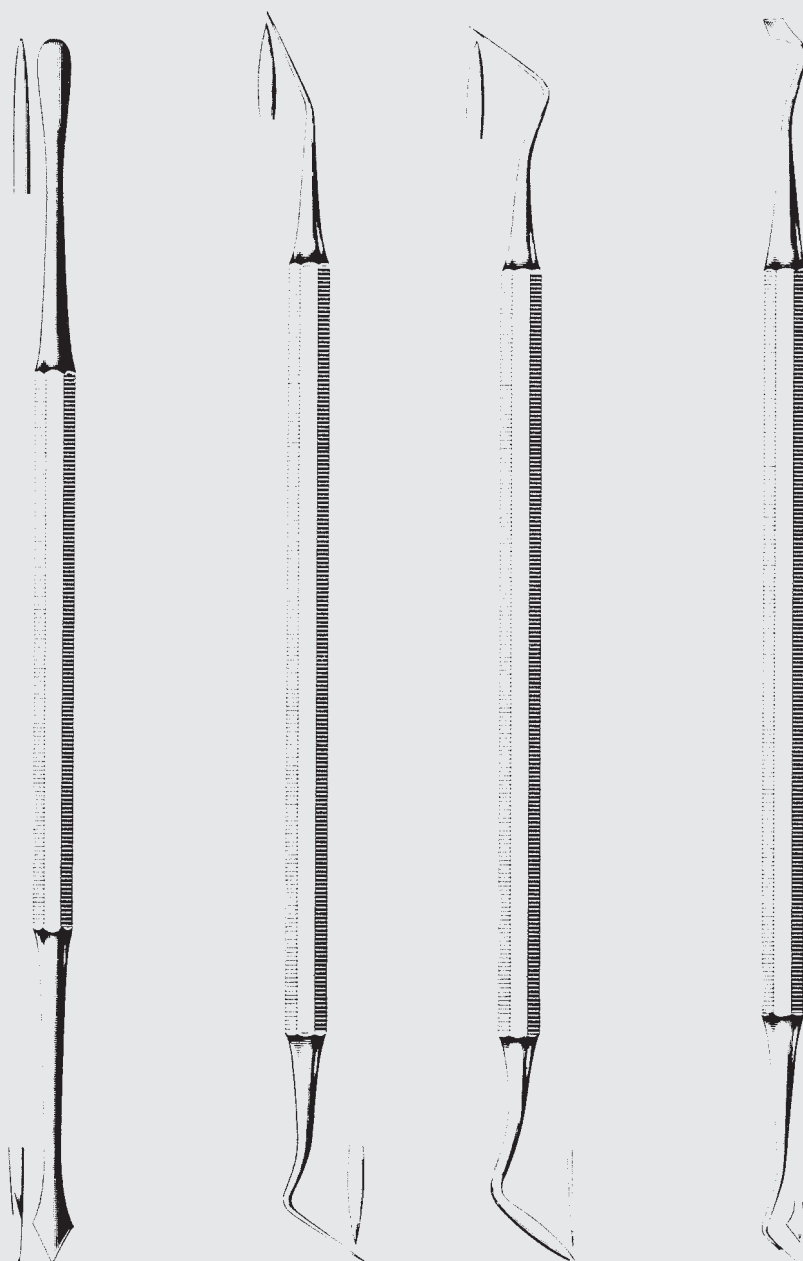

GRITMAN
86-3500-01

WARD
86-3504-01 86-3504-02
Fig. 1 Fig. 2

FRAHM
86-3506-01

PROTHETIK,
ORTHODONTIE

PROSTHETICS,
ORTHODONTICS

PROTHÈSE,
ORTHODONTIE

PRÓTESIS,
ORTODONCIA

PROTESI,
ORTODONZIA

ZEPF[®]
α
INSTRUMENTS

86-3506-01

86.5

Modellierinstrumente
 Modelling Carvers
 Instruments à modeler
 Instrumentos para modelar
 Strumenti per modellare

PROTHETIK,
 ORTHODONTIE

PROSTHETICS,
 ORTHODONTICS

PROTHÈSE,
 ORTHODONTIE

PRÓTESIS,
 ORTODONCIA

PROTESI,
 ORTODONZIA

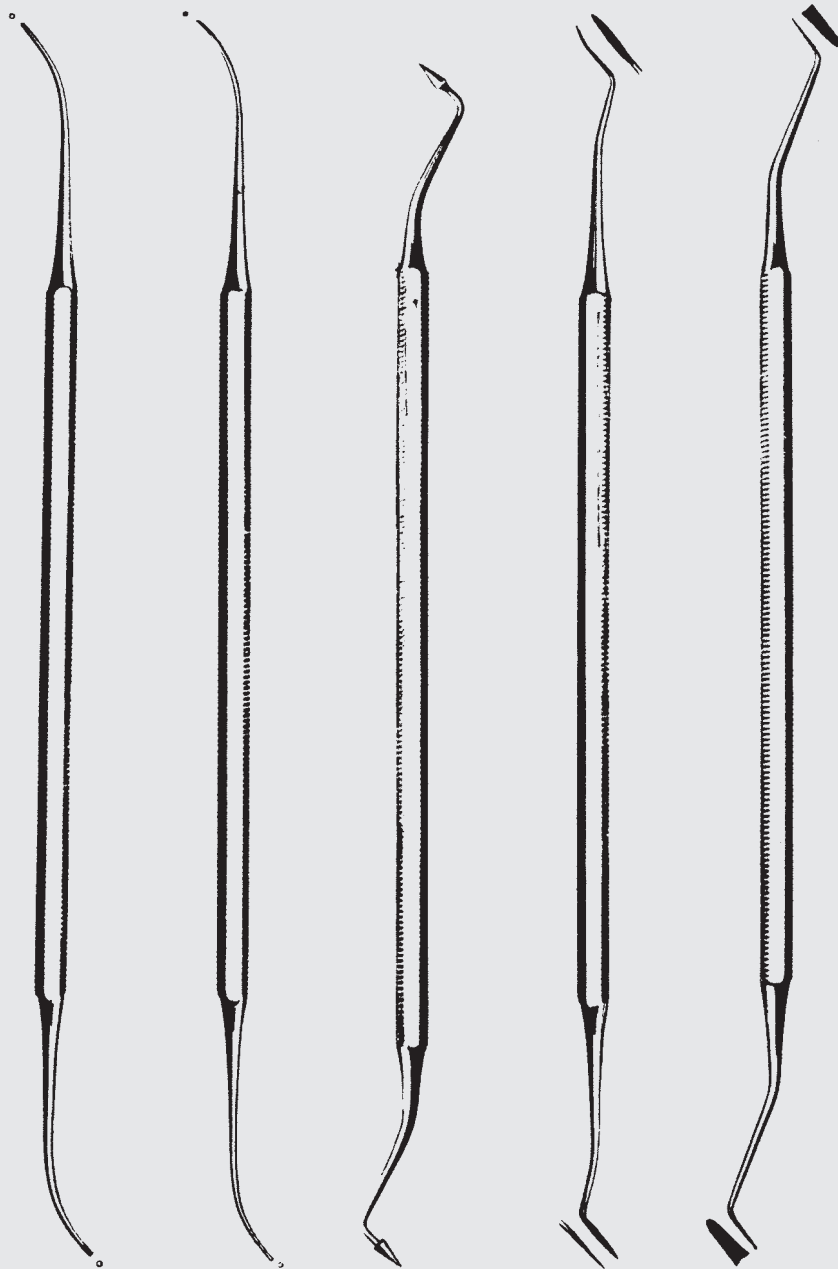

P K THOMAS				
86-3600-01	86-3600-02	86-3600-03	86-3600-04	86-3600-05
Fig. 1	Fig. 2	Fig. 3	Fig. 4	Fig. 5



86-3600-01

86.6

Modellierinstrumente
Modelling Carvers
Instruments à modeler
Instrumentos para modelar
Strumenti per modellare



SHOSHAN
86-3601-00
SHO-A



W.A.C.D.
86-3602-00



86-3603-02



86-3603-90

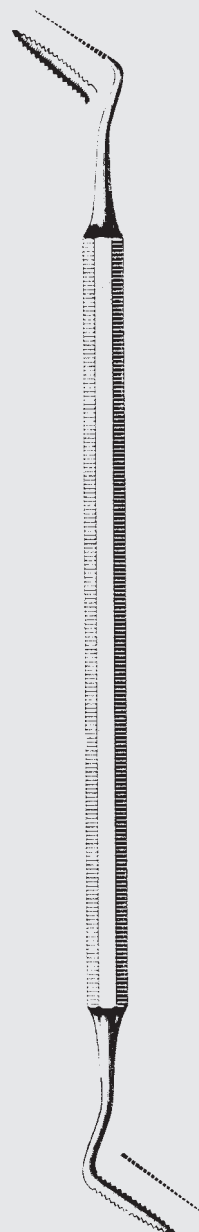

WAERHAUG
86-3606-00

PROTHETIK,
ORTHODONTIE

PROSTHETICS,
ORTHODONTICS

PROTHÈSE,
ORTHODONTIE

PRÓTESIS,
ORTODONCIA

PROTESI,
ORTODONZIA

ZEPF[®]
α
INSTRUMENTS

86-3606-00

86.7

Modellierinstrumente
 Modelling Carvers
 Instruments à modeler
 Instrumentos para modelar
 Strumenti per modellare

PROTHETIK,
 ORTHODONTIE

PROSTHETICS,
 ORTHODONTICS

PROTHÈSE,
 ORTHODONTIE

PRÓTESIS,
 ORTODONCIA

PROTESI,
 ORTODONZIA

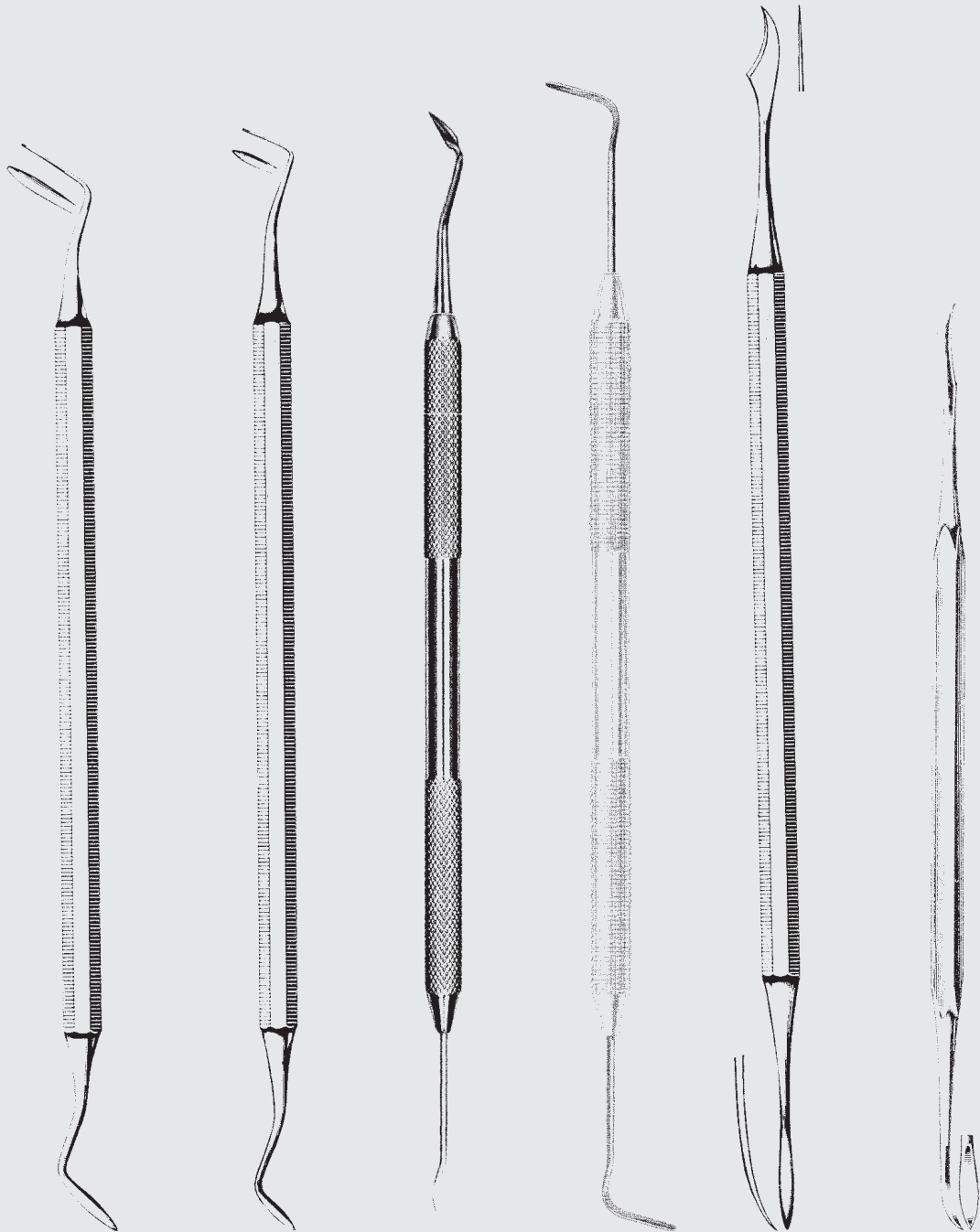

HOLLENBACK	
86-3700-30	86-3700-31
Fig. 3	Fig. 3S

WILAND
86-3701-08
Fig. 8

86-3702-00
interproximal

86-3705-01
Fig. 5

HYLIN
86-3902-01

Modellierinstrumente
Modelling Carvers
Instruments à modeler
Instrumentos para modelar
Strumenti per modellare

PROTHETIK,
ORTHODONTIE

PROSTHETICS,
ORTHODONTICS

PROTHÈSE,
ORTHODONTIE

PRÓTESIS,
ORTODONCIA

PROTESI,
ORTODONZIA

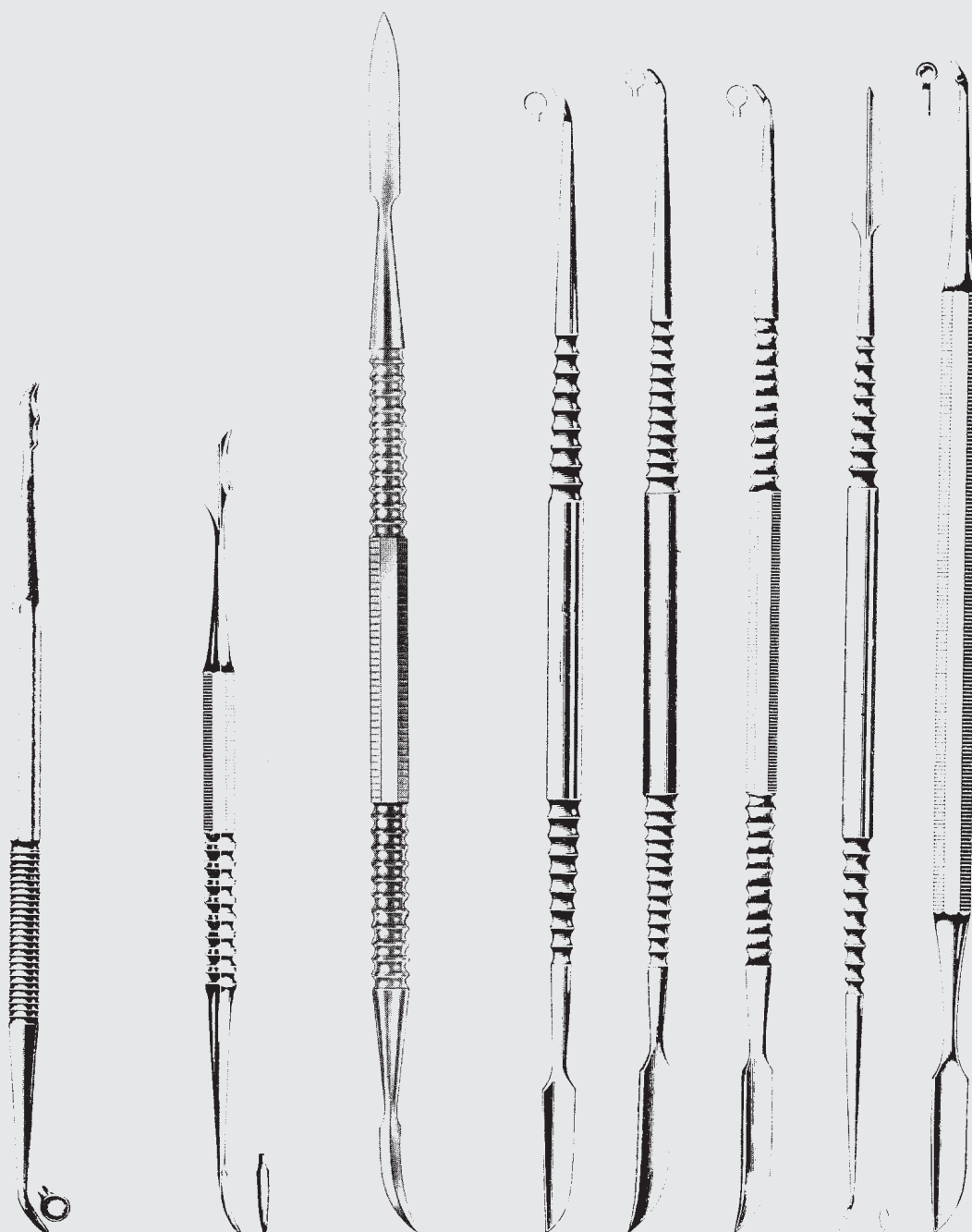

ZAHLE

86-3904-01

86-3905-01

REEVES

86-3906-00

LE CRON

86-4001-01

86-4002-01

86-4003-01

86-4004-01

86-4005-01

ZEPF[®]
α
INSTRUMENTS

86-4005-01

86.9

Modellierinstrumente
Modelling Carvers
Instruments à modeler
Instrumentos para modelar
Strumenti per modellare

PROTHETIK,
ORTHODONTIE

PROSTHETICS,
ORTHODONTICS

PROTHÈSE,
ORTHODONTIE

PRÓTESIS,
ORTODONCIA

PROTESI,
ORTODONZIA



VEHE

86-4100-01

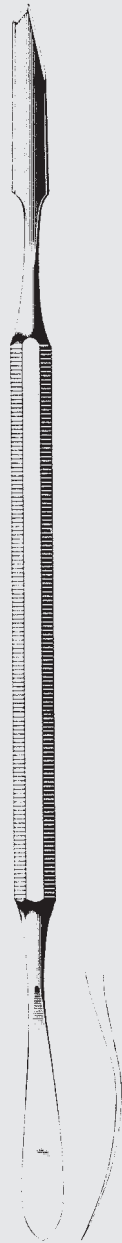

FJELDSTAD

86-4106-01



ROACH

86-4204-01



86-4205-01



RIEGNER

86-4208-01

ZEPF[®]
α
INSTRUMENTS

86-4100-01

86.10

Modellierinstrumente
Modelling Carvers
Instruments à modeler
Instrumentos para modelar
Strumenti per modellare

PROTHETIK,
ORTHODONTIE

PROSTHETICS,
ORTHODONTICS

PROTHÈSE,
ORTHODONTIE

PRÓTESIS,
ORTODONCIA

PROTESI,
ORTODONZIA

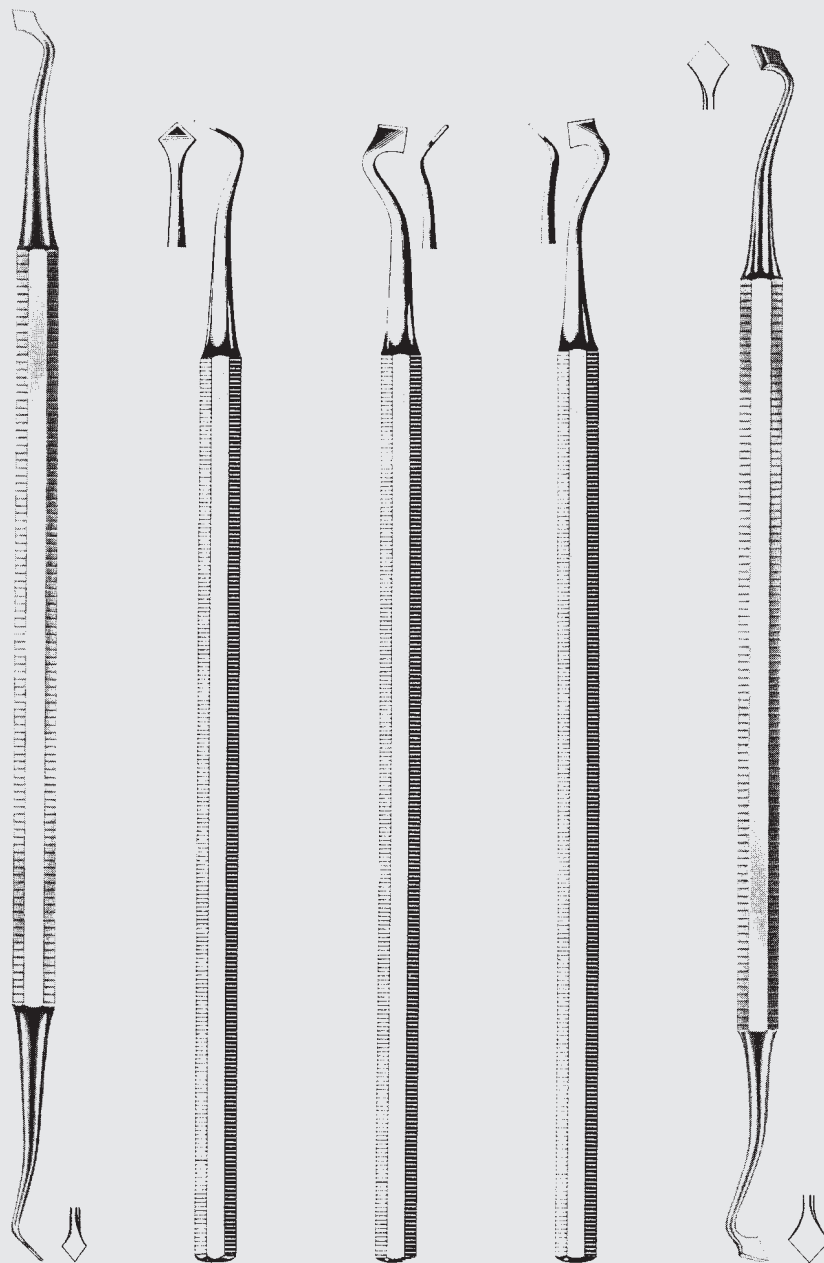

FRAHM				
86-4305-01	86-4305-02	86-4305-06	86-4305-10	86-4306-00
Fig. 1	Fig. 2	Fig. 6	Fig. 10	Fig. 6/10

ZEPF[®]
α
INSTRUMENTS

86-4306-00

86.11

Wachs-, Porzellan- und Modellierinstrumente
 Wax, Porcelain, and Modelling Carvers
 Instruments et spatules à cire, à porcelaine et à modeler
 Talladores y espátulas para cera, porcelana y para modelar
 Strumenti per cera, porcellana e per modellare

PROTHETIK,
 ORTHODONTIE

PROSTHETICS,
 ORTHODONTICS

PROTHÈSE,
 ORTHODONTIE

PRÓTESIS,
 ORTODONCIA

PROTESI,
 ORTODONZIA



ERMERT
 86-4500-01 86-4501-01

BEALE
 86-4602-01 86-4602-02

GRITMAN
 86-4605-01

WESTON
 86-4702-00

Fig. 7A



86-4500-01

86.12

Wachsmesser
 Wax Knives
 Couteaux à cire
 Cuchillos para cera
 Coltelli per cera

PROTHETIK,
 ORTHODONTIE

PROSTHETICS,
 ORTHODONTICS

PROTHÈSE,
 ORTHODONTIE

PRÓTESIS,
 ORTODONCIA

PROTESI,
 ORTODONZIA



GISY WILD
 86-4800-15
 15,0 cm



cm **FAHNENSTOCK**
 13,0 86-4802-13
 17,0 86-4802-17

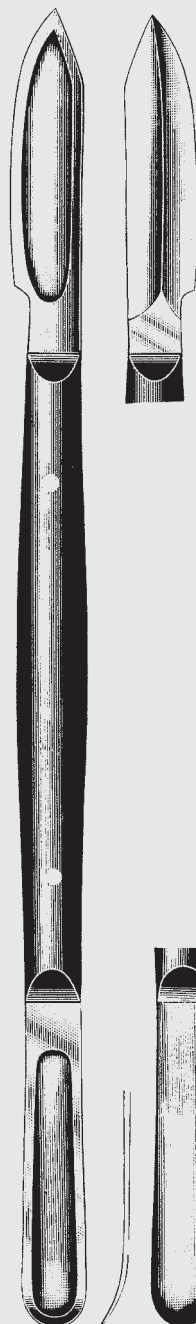

cm **LESSMANN**
 13,0 86-4804-13
 17,0 86-4804-17

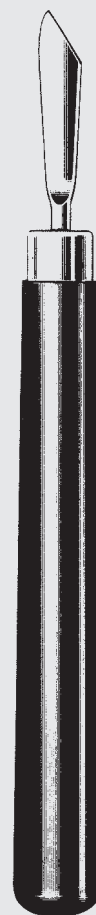

ANTKOVIK
 86-4806-12
 12,5 cm

ZEPF[®]

 INSTRUMENTS

86-4806-12

86.13

Kroneninstrumente
 Instruments for Crown Work
 Instruments à couronnes
 Instrumentos para coronas
 Strumenti per corone

PROTHETIK,
 ORTHODONTIE

PROSTHETICS,
 ORTHODONTICS

PROTHÈSE,
 ORTHODONTIE

PRÓTESIS,
 ORTODONCIA

PROTESI,
 ORTODONZIA

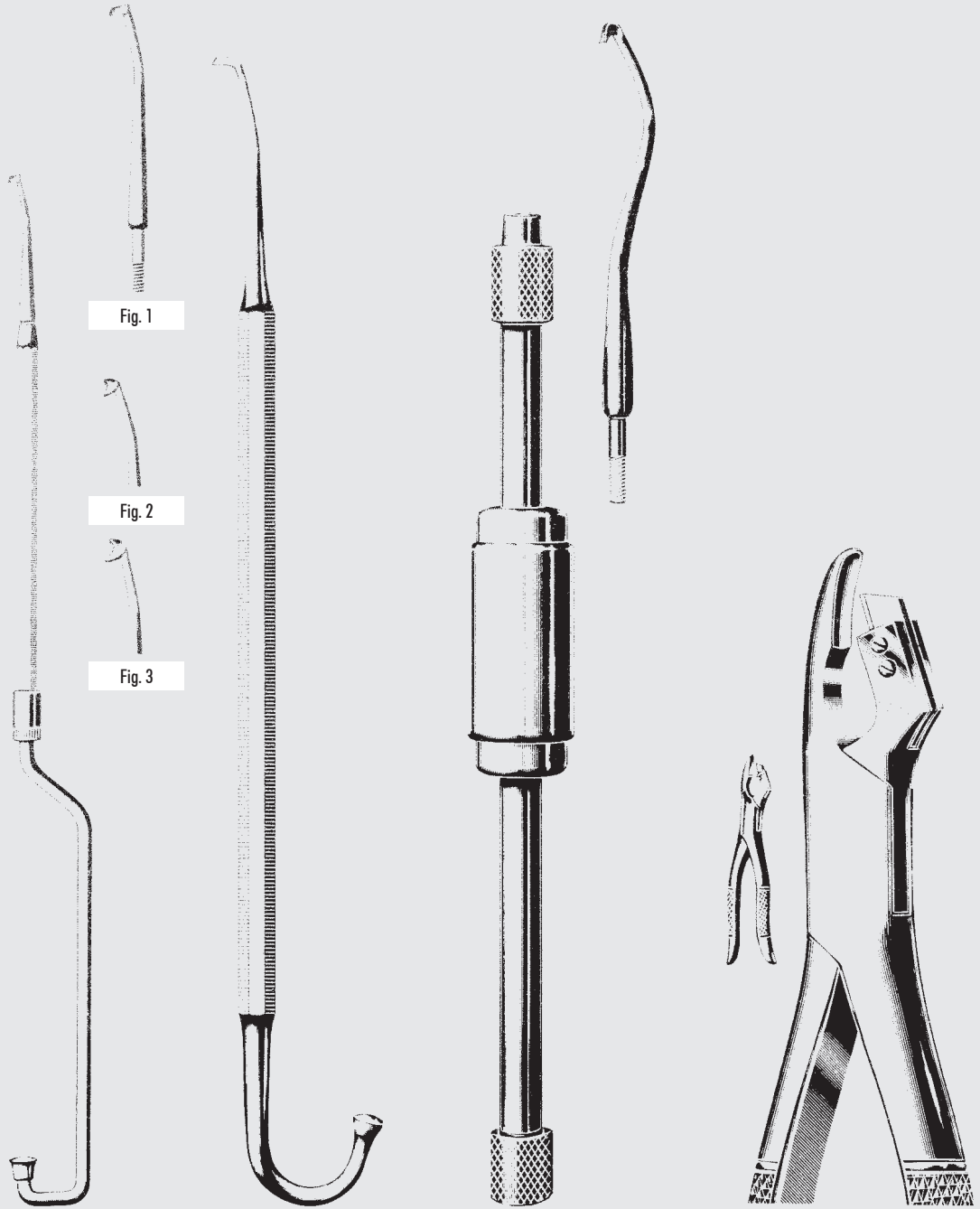

Fig. 1

Fig. 2

Fig. 3

SCHROEDER
 86-5703-00
 Compl.

TREYMAN
 86-5708-01

MILLER
 86-5800-01

MONFORT
 86-5900-19

Artikulationspapierpinzette, Bandaufsetzer, Bandtreiber
 Articulation Paper Forceps, Band Setter, Band Pusher
 Pince pour papier à articulation, Adaptateur de rubans, Pousse-rubans
 Pinza para papel de articulación, Empujadores para bandas
 Pinzetta per carta di articolazione, Applicatore per bande, Adattatore per bande

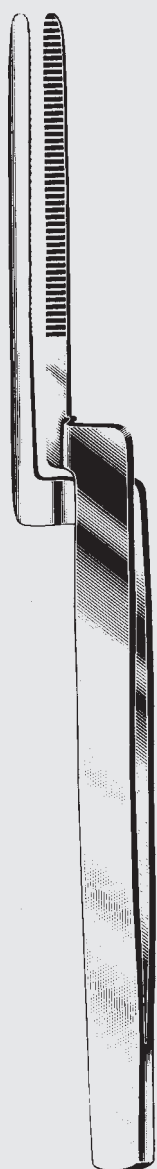

MILLER
 86-5902-15
 15,0 cm



86-5906-15
 15,0 cm

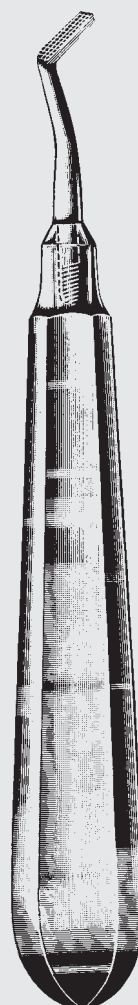

MERSHON
 86-5908-13
 13,5 cm

PROTHETIK,
 ORTHODONTIE

PROSTHETICS,
 ORTHODONTICS

PROTHÈSE,
 ORTHODONTIE

PRÓTESIS,
 ORTODONCIA

PROTESI,
 ORTODONZIA

ZEPF[®]

 INSTRUMENTS

86-5908-13

86.15

PROTHETIK,
ORTHODONTIE

PROSTHETICS,
ORTHODONTICS

PROTHÈSE,
ORTHODONTIE

PRÓTESIS,
ORTODONCIA

PROTESI,
ORTODONZIA

PROTHETIK, ORTHODONTIE
PROSTHETICS, ORTHODONTICS
PROTHÈSE, ORTHODONTIE
PRÓTESIS, ORTODONCIA
PROTESI, ORTODONZIA

Niethämmer, Hornhammer,
 Filmklammer, Flachzange
 Riveting Hammers, Horn Hammer, Film Clip,
 Flat Nose Pliers
 Marteaux à river, Maillet en corne,
 Pince porte-pellicules, Pince plate
 Martillos de remachar, Martillo de cuerno natural,
 Pinza porta-películas, Alicata de picos chatos
 Martelli ribaditori, Martello in corno,
 Porta-pellicole, Pinza a punte piatte

PROTHETIK,
 ORTHODONTIE

PROSTHETICS,
 ORTHODONTICS

PROTHÈSE,
 ORTHODONTIE

PRÓTESIS,
 ORTODONCIA

PROTESI,
 ORTODONZIA

Flachzangen
 Flat Nose Pliers
 Pincas plates
 Pinzas de picos chatos
 Pinza a punte patte

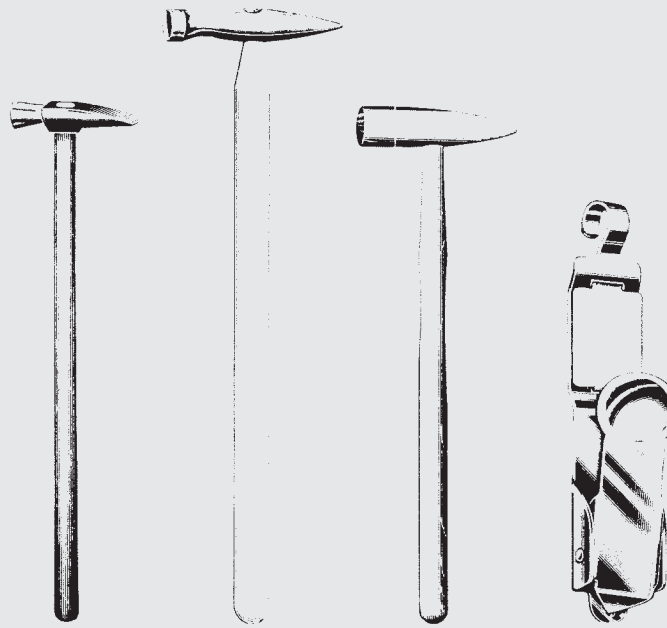

87-1002-21
 21,0 cm

87-1100-24
 24,0 cm

87-1104-21
 21,0 cm

87-2200-05
 Film Clip

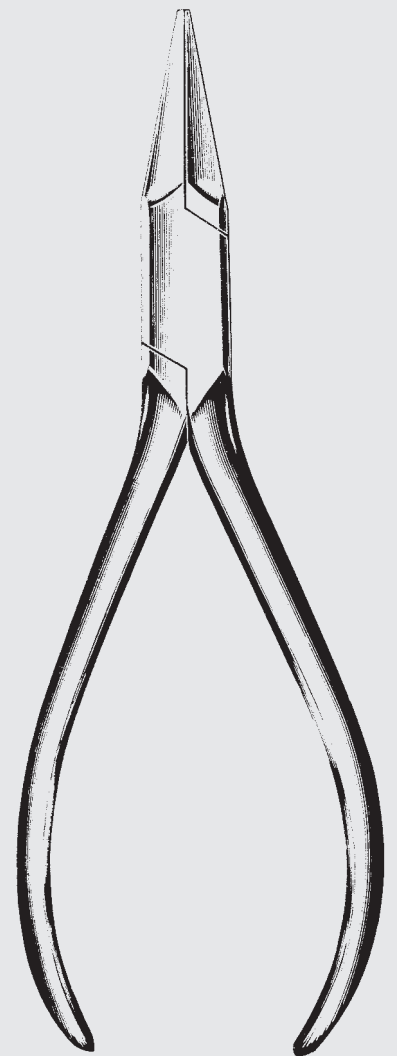

87-5005-14
 14,0 cm

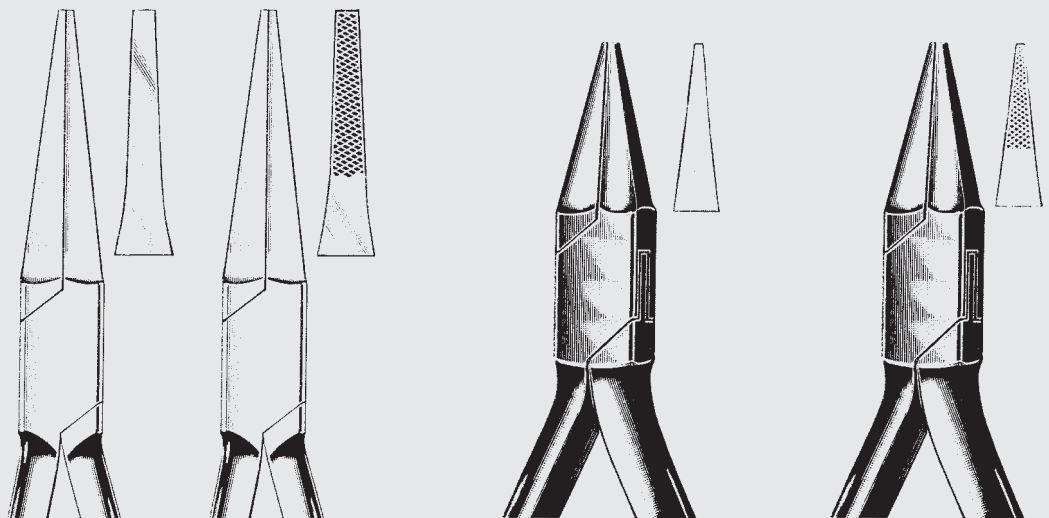

LANGBECK
 87-5107-14 87-5108-14
 14,0 cm 14,0 cm

87-5201-13
 12,5 cm

87-5202-13
 12,5 cm

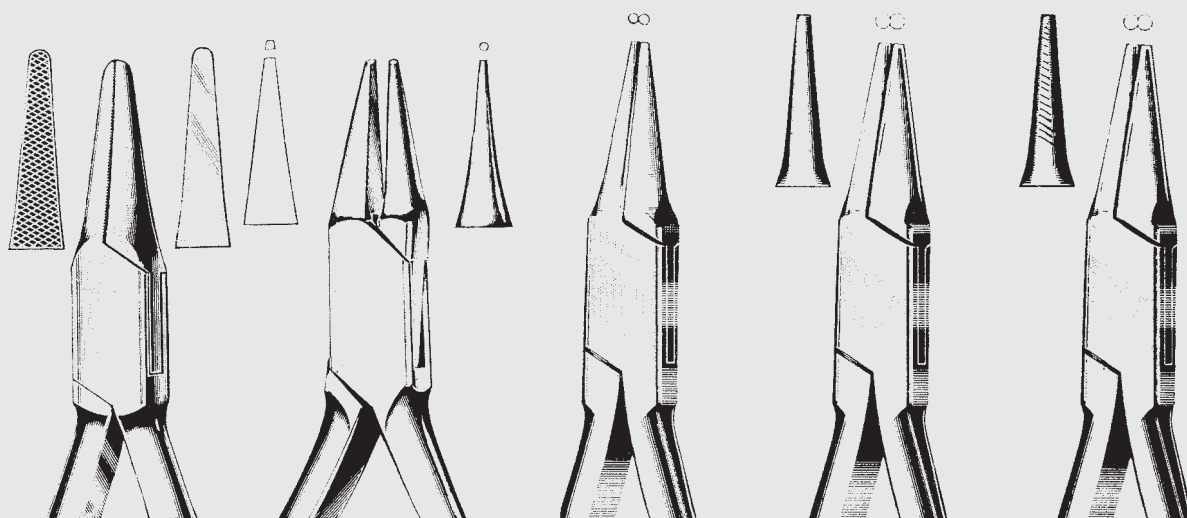

Flach- und Rundzangen
 Flat and Round Nose Pliers
 Pinces plates et à mors ronds
 Pinzas de picos chatos y redondos
 Pinze a punte piatte e rotonde

PROTHETIK,
 ORTHODONTIE

PROSTHETICS,
 ORTHODONTICS

PROTHÈSE,
 ORTHODONTIE

PRÓTESIS,
 ORTODONCIA

PROTESI,
 ORTODONZIA

GOSLEE
 87-5204-14
 14,0 cm

87-5308-15
 15,0 cm

87-5400-13
 13,0 cm

87-5402-13
 13,0 cm

87-5403-13
 13,0 cm

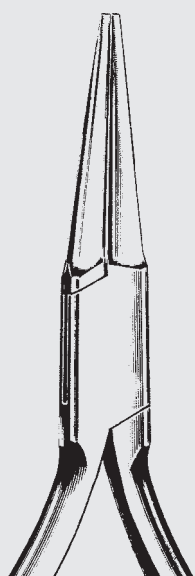

LANGBECK
 87-5404-14
 14,0 cm



DUMONT
 87-5504-11 - 87-5506-11

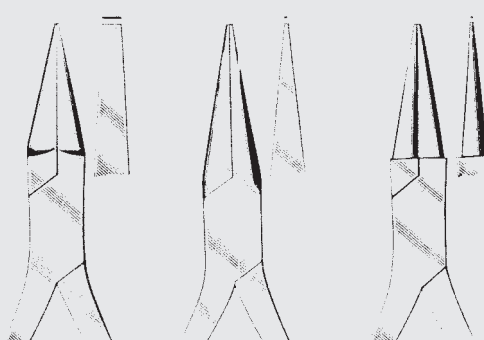

87-5504-11
 11,5 cm

87-5505-11
 11,5 cm

87-5506-11
 11,5 cm

Zwickzangen, Draht- und Bügelbiegezangen
 End Nippers, Wire and Bar Bending Pliers
 Pinces coupantes, Pincers à plier les fils et les barres
 Alicates cortantes, Alicates para doblar alambres y barras
 Pinze per troncare fili, Pinze per piegare fili e barre

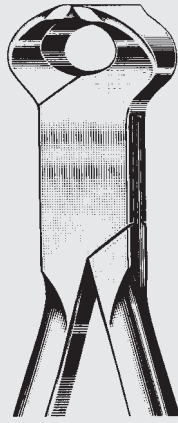

87-5602-12
12,5 cm

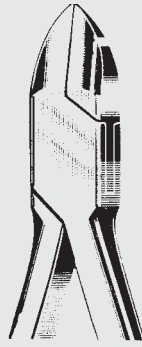

87-5603-11
11,0 cm

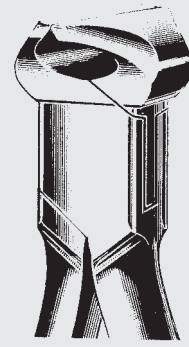

87-5604-12
12,0 cm

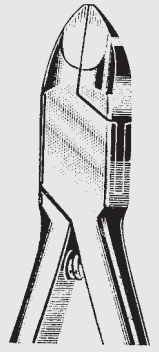

87-5702-11
11,0 cm

PROTHETIK,
ORTHODONTIE

PROSTHETICS,
ORTHODONTICS

PROTHÈSE,
ORTHODONTIE

PRÓTESIS,
ORTODONCIA

PROTESI,
ORTODONZIA

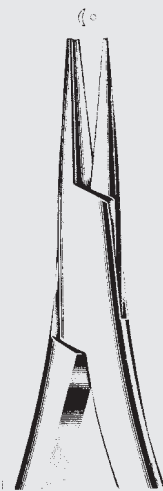

SCHWARZ I
87-6004-13
13,0 cm

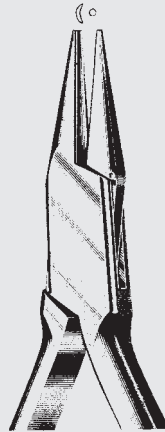

SCHWARZ II
87-6006-13
13,0 cm



SCHWARZ III
87-6008-13
13,0 cm

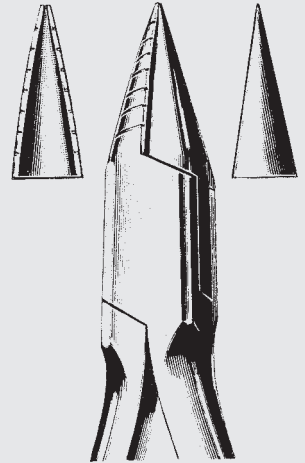

SCHWARZ
87-6102-14
14,5 cm

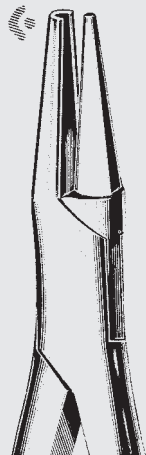

FISCHER
87-6106-14
14,0 cm

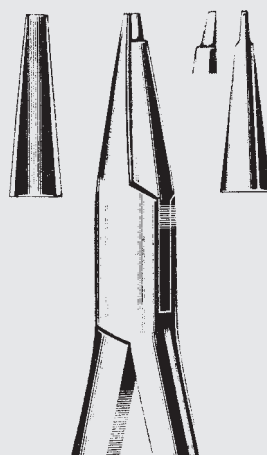

ANDRESEN
87-6200-12
14,0 cm

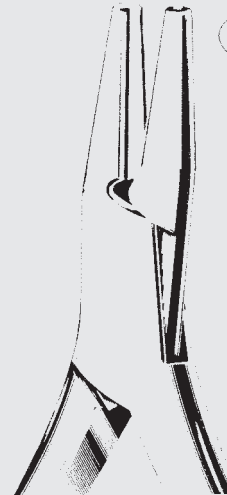

McKELLOPS
87-6204-17
17,0 cm

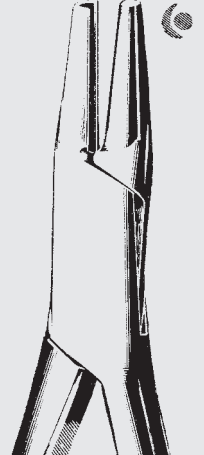

87-6206-16
16,0 cm

Universalzangen
 Universal Pliers
 Pincers universelles
 Alicates universales
 Pinze universali

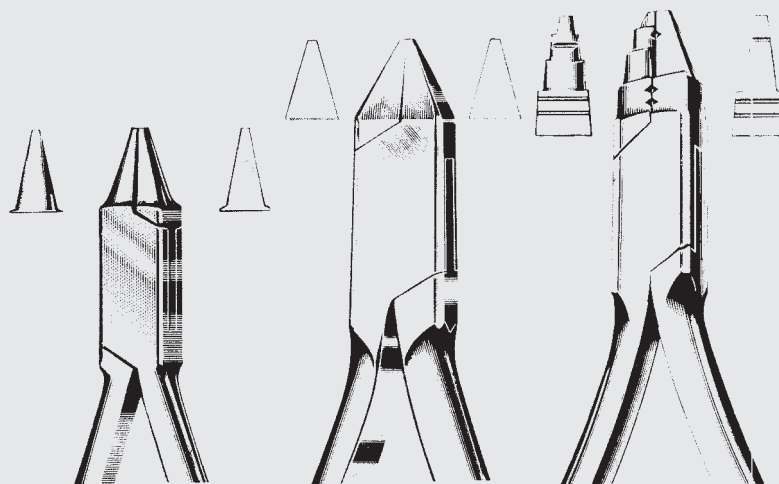

ANGLE
 87-6500-12
 12,0 cm

ADAMS
 87-6504-13
 13,0 cm

YOUNG
 87-6600-13
 13,0 cm

PROTHETIK,
 ORTHODONTIE

PROSTHETICS,
 ORTHODONTICS

PROTHÈSE,
 ORTHODONTIE

PRÓTESIS,
 ORTODONCIA

PROTESI,
 ORTODONZIA

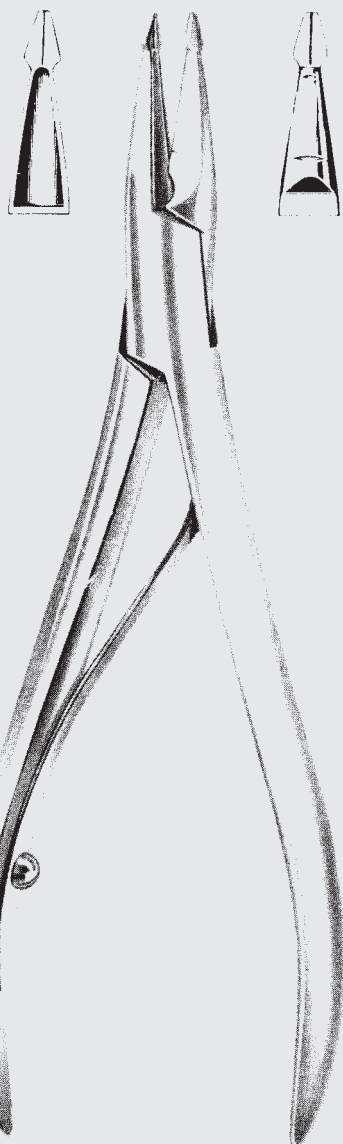

STADLER
 87-6302-15
 15,0 cm

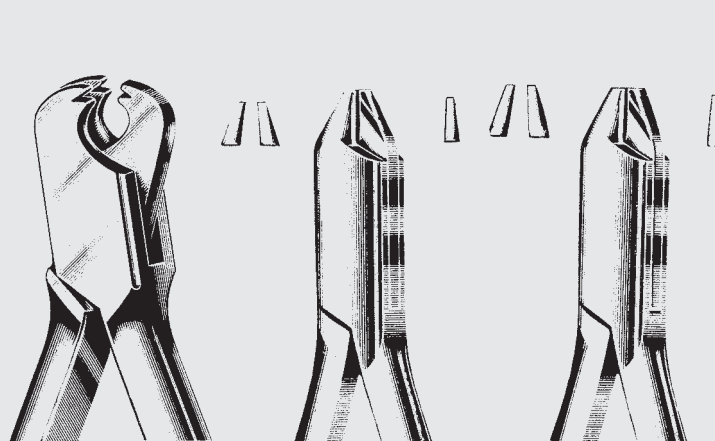

ADERER
 87-6606-14
 14,0 cm

ADERER
 87-6702-12
 11,5 cm

ADERER
 87-6704-13
 13,0 cm

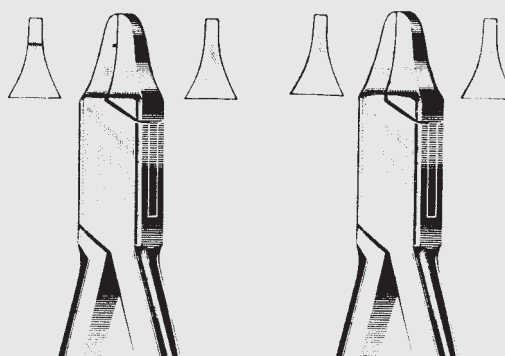

ANGLE
 87-6708-13
 13,0 cm

ANGLE
 87-6709-13
 13,0 cm

Klammer-, Draht- und Bogenbiegezaugen
 Clasp, Wire, and Arch Bending Pliers
 Pinces à plier les crochets, les fils et les arcs
 Pinzas para doblar ganchos, hilos y arcos
 Pinze per piegare ganci, fili ed archi

PROTHETIK,
 ORTHODONTIE

PROSTHETICS,
 ORTHODONTICS

PROTHÈSE,
 ORTHODONTIE

PRÓTESIS,
 ORTODONCIA

PROTESI,
 ORTODONZIA



WALDSACHS (Universal)
 87-6900-15
 15,5 cm

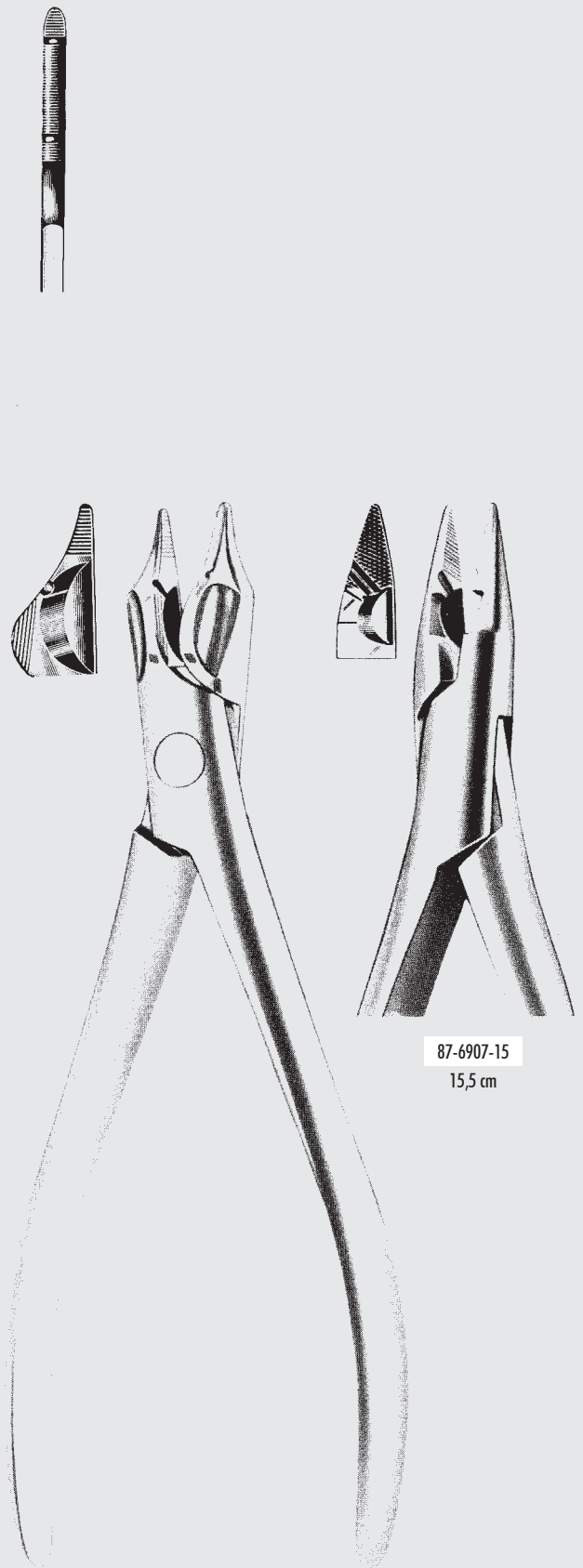

87-6907-15
 15,5 cm

Universal
 87-6904-15
 15,5 cm

Kupferringabnehmezange, Teleskopkronenzangen, Bandabnehmezangen
 Copper Ring Removing Pliers, Pliers for Telescope Crowns, Band Removing Pliers
 Pince pour enlever les bagues en cuivre, Pinces pour couronnes télescopiques, Pincés à enlever les rubans
 Alicates para quitar anillos de cobre, Alicates para coronas telescópicas, Alicates para sacar bandas
 Pinza per togliere anelli di rame, Pinze per corone telescopiche, Pinze per levare bande

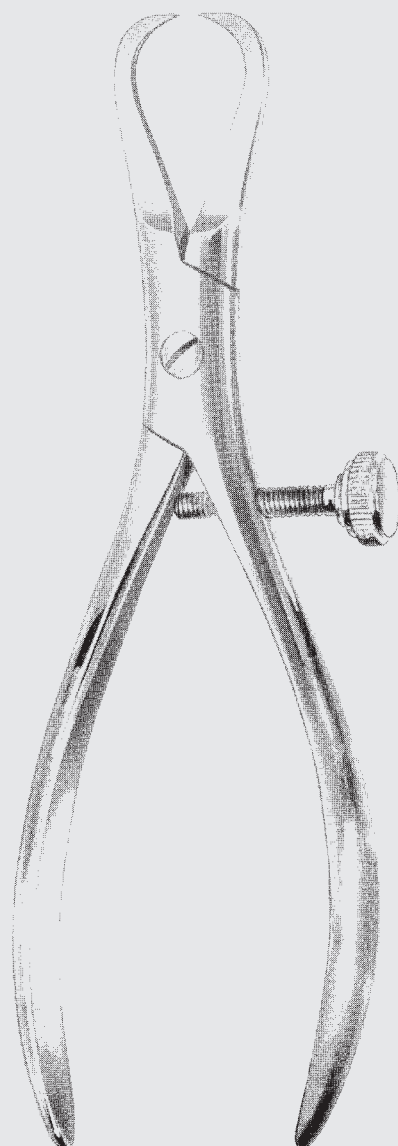

FURRER
 87-7002-15
 15,0 cm

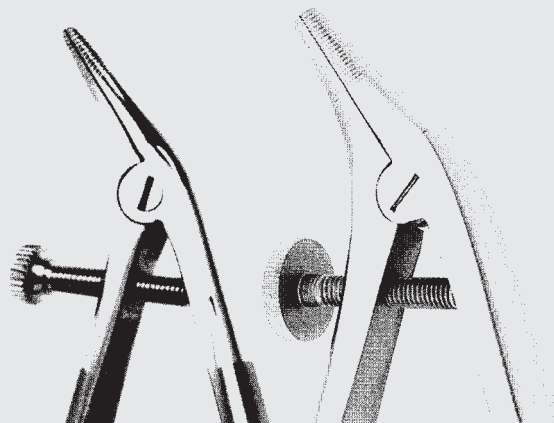

BOEHM
 87-7003-12 87-7003-15
 12,0 cm 15,0 cm

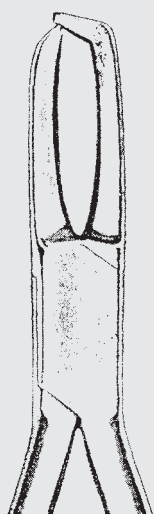

OLIVER JONES
 87-7005-15
 15,0 cm

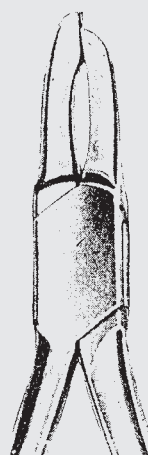

OLIVER
 87-7007-15 87-7009-15
 15,0 cm 15,0 cm

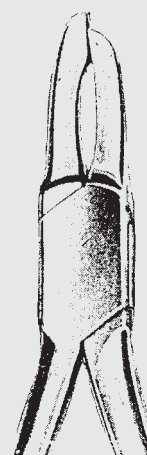

PROTHETIK,
 ORTHODONTIE

PROSTHETICS,
 ORTHODONTICS

PROTHÈSE,
 ORTHODONTIE

PRÓTESIS,
 ORTODONCIA

PROTESI,
 ORTODONZIA



87-7009-15

87.7

Drahtfass- und Ligaturzangen
 Wire Seizing and Ligature Pliers
 Pinces pour saisir les fils et pour les ligatures
 Pinzas para coger alambres y para ligaduras
 Pinze per afferrare fili e per legature

PROTHETIK,
 ORTHODONTIE

PROSTHETICS,
 ORTHODONTICS

PROTHÈSE,
 ORTHODONTIE

PRÓTESIS,
 ORTODONCIA

PROTESI,
 ORTODONZIA

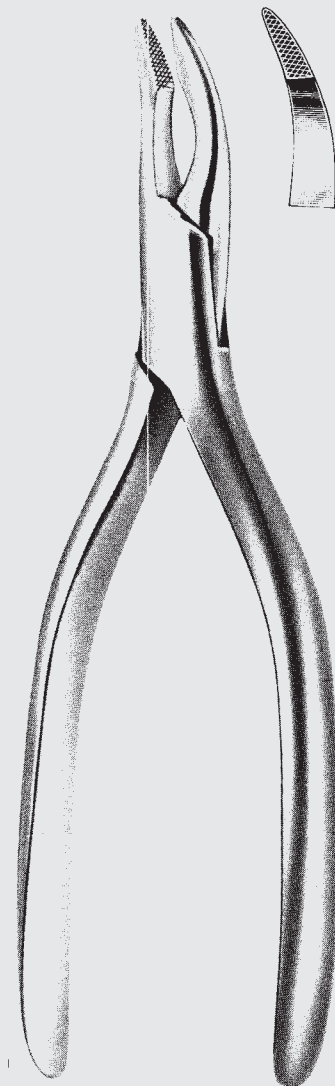

WEINGART
 87-7101-14
 14,0 cm

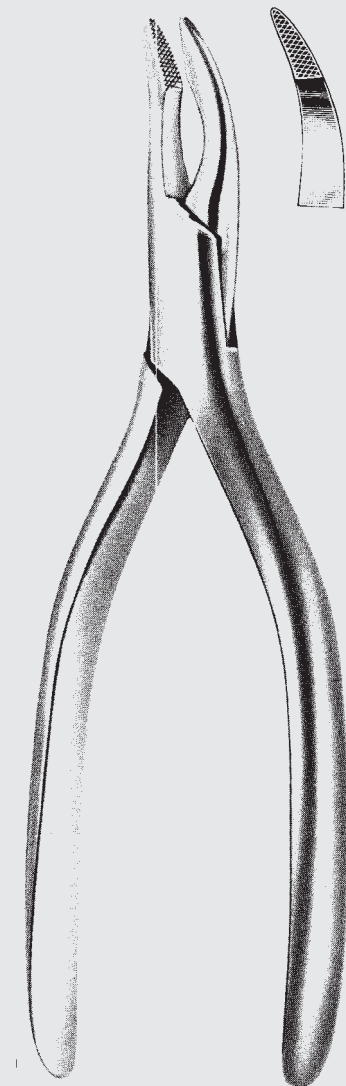

KORKHAUS
 87-7104-15
 15,0 cm

ZEPF[®]
α
 INSTRUMENTS

87-7101-14

87.8

Kronenformzange, Konturzange, Kronen- und Ligaturzangen
 Crown Forming Pliers, Contouring Pliers, Crown and Ligature Pliers
 Pince pour former les couronnes, Pince à bouteroller, Pinces à couronnes et à ligatures
 Alicates para formar coronas, Alicates para contornear, Alicates para coronas y ligaduras
 Pinza per formare corone, Pinza per contornare, Pinze per corone e per legature

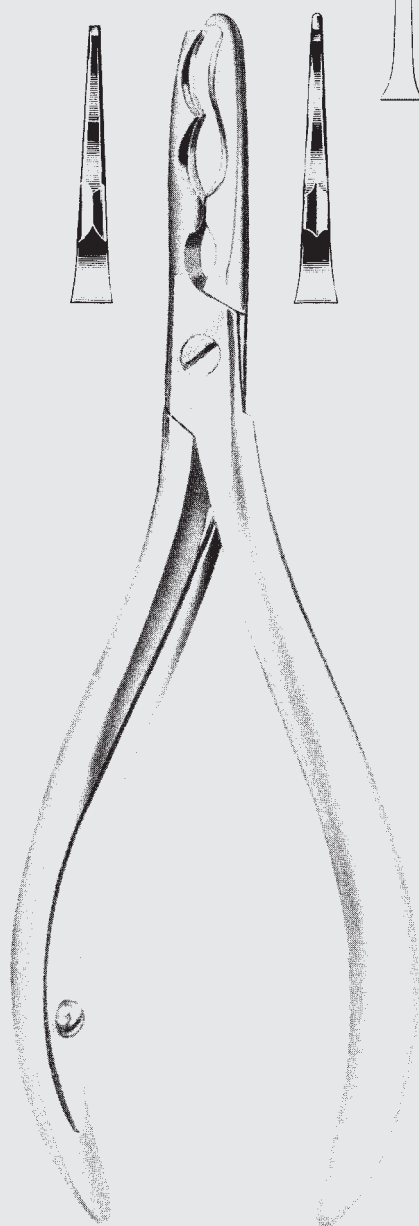

TRYFUS
 87-7400-16
 16,5 cm

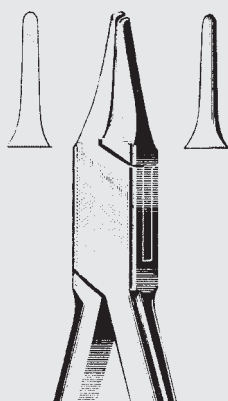

PEESO
 87-7402-12
 12,0 cm



HOW	
87-7500-14	87-7501-14
14,0 cm	14,0 cm

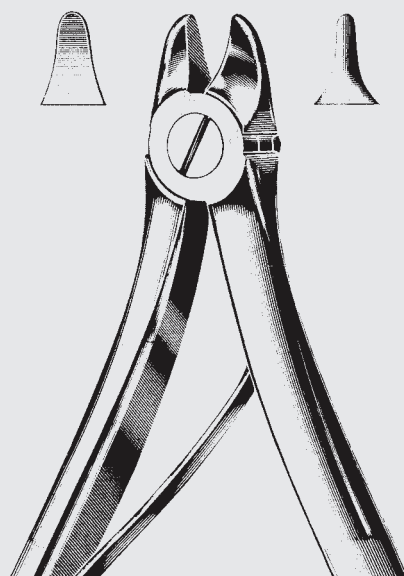
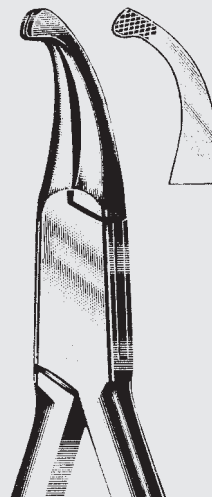

PEESO
 87-7700-14
 14,5 cm

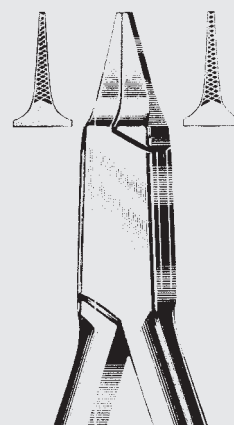

FREVERT
 87-7706-12
 12,0 cm

PROTHETIK,
 ORTHODONTIE

PROSTHETICS,
 ORTHODONTICS

PROTHÈSE,
 ORTHODONTIE

PRÓTESIS,
 ORTODONCIA

PROTESI,
 ORTODONZIA



87-7706-12

87.9

Konturzangen, Ligaturschneidezange
 Contouring Pliers, Ligature Cutting Pliers
 Pinces à bouleroller, Pince coupante pour ligatures
 Alicates para contornear, Alicata cortante para ligaduras
 Pinze per contornare, Pinze per troncare fili

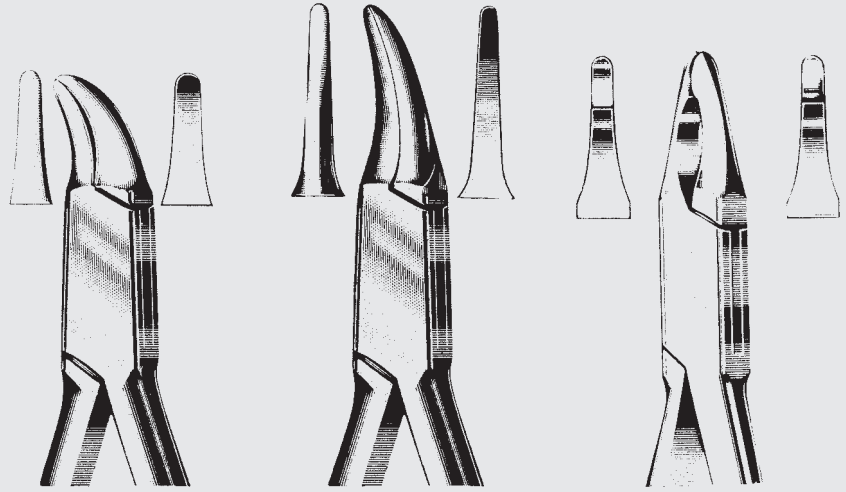

REYNOLD
 87-7803-12
 12,5 cm

GORDON
 87-7805-14
 14,0 cm

JOHNSON
 87-7808-13

PROTHETIK,
 ORTHODONTIE

PROSTHETICS,
 ORTHODONTICS

PROTHÈSE,
 ORTHODONTIE

PRÓTESIS,
 ORTODONCIA

PROTESI,
 ORTODONZIA

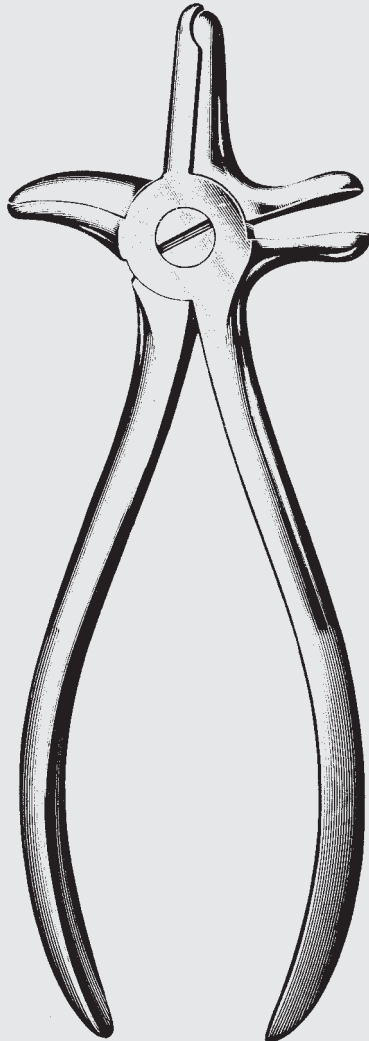

TRIPLEX
 87-7800-14
 14,0 cm

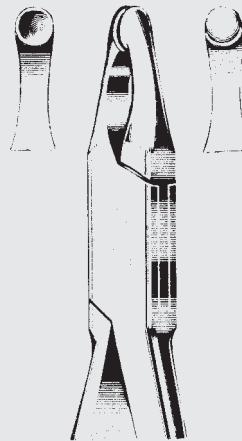

ABELL
 87-7904-13
 13,0 cm

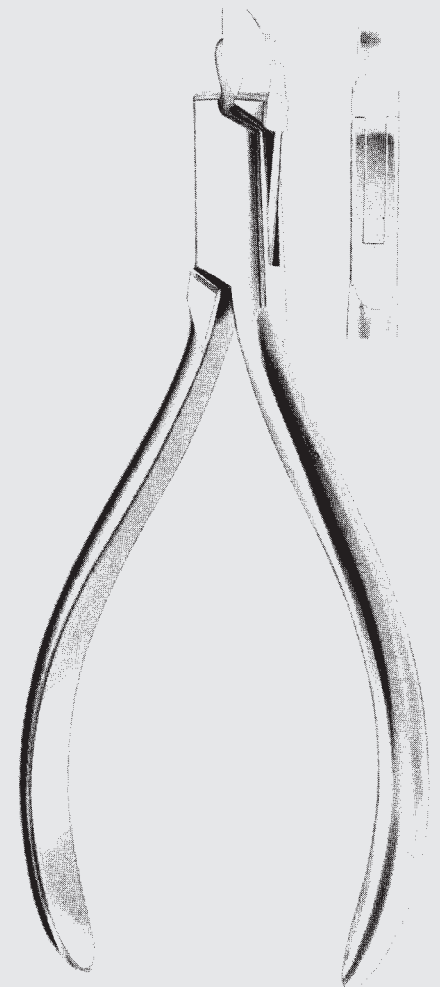

ANGLE
 87-7906-13

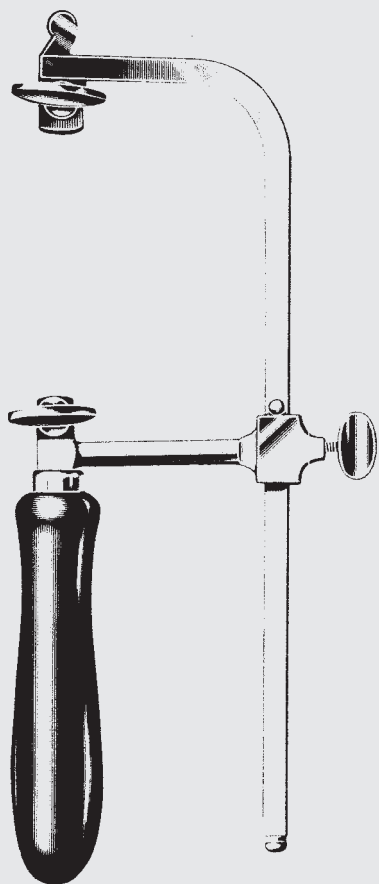

87-7908-20



87-7909-01

Für Metall
For metal
Pour métal
Para metal
Per metallo



87-7909-02

Für Kautschuk
For vulcanite
Pour caoutchouc
Para vulcanita
Per gomma vulcanizzata



87-7909-03

Für Gips
For plaster
Pour plâtre
Para yeso
Per gesso

Laubsägebogen, verstellbar, Laubsäge-Blätter
Jig Saw, Jig Saw Blades
Scie à contourner, Lames de scie à contourner
Arco de sierra de marquetería, Hojas de sierra de marquetería
Archetto da traforo, Lamette per sega da traforo

PROTHETIK,
ORTHODONTIE

PROSTHETICS,
ORTHODONTICS

PROTHÈSE,
ORTHODONTIE

PRÓTESIS,
ORTODONCIA

PROTESI,
ORTODONZIA



BOLEY
87-8106-10

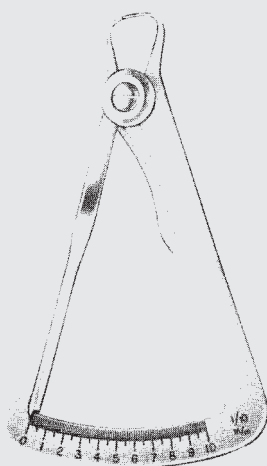

IWANSON	
87-8304-15	87-8306-15
für Gold	für Wachs
for gold	for wax
pour or	pour cire
para oro	para cera
per oro	per cera

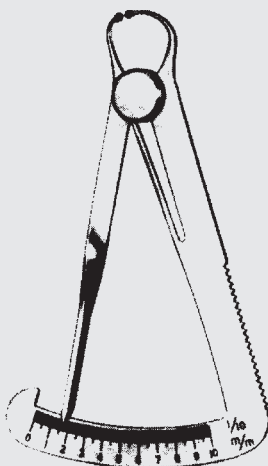

87-8502-00
„Clamping tweezer“

ZEPF[®]
INSTRUMENTS

87-8502-00

87.11

Spirituslampen
Alcohol Burners
Lampes à alcool
Lámparas de alcohol
Lampade a spirito

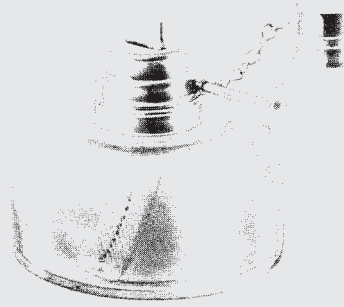

87-9001-12
100 ml

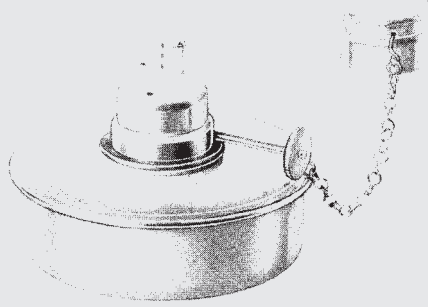

87-9004-07
75 ml

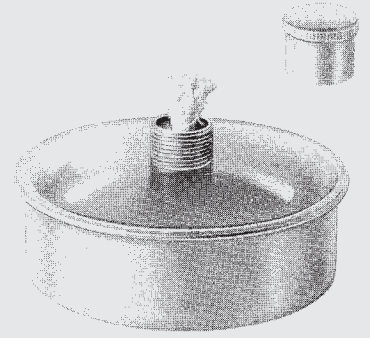

87-9102-12
120 ml

PROTHETIK,
ORTHODONTIE

PROSTHETICS,
ORTHODONTICS

PROTHÈSE,
ORTHODONTIE

PRÓTESIS,
ORTODONCIA

PROTESI,
ORTODONZIA

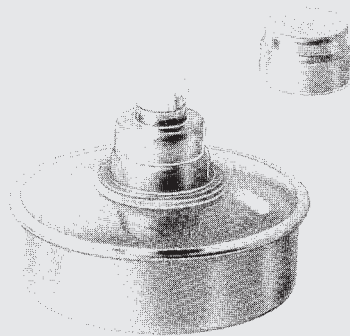

87-9200-12
120 ml

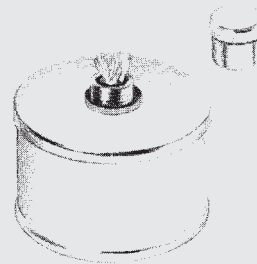

87-9204-05
50 ml

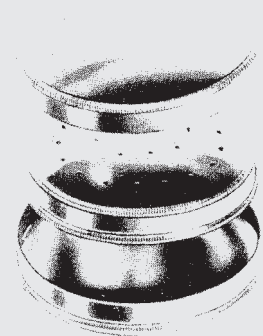

88-1102-65
65 x 15 mm

Nierenschalen, Wattespender
Kidney Trays, Cotton Dispensers
Bassins rénifores, Porte-coton
Riñoneras, Distribuidores de algodón
Bacinelli reniformi, Distributori di cotone

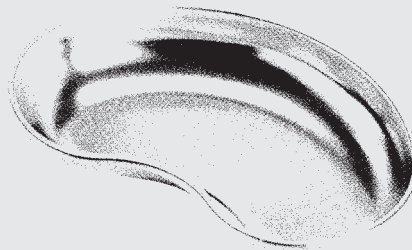

cm	Model
20,0	88-1309-17
25,0	88-1309-25
27,0	88-1309-27

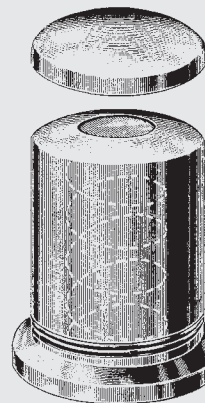

88-5600-01
50 x 75 mm

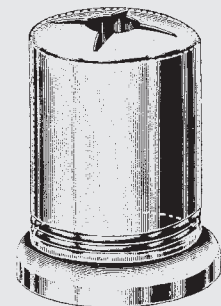

METHOD

88-5608-01

ZEPF[®]
α
INSTRUMENTS

87-9001-12

87.12

DENTAL
INSTRUMENTE

DENTAL
INSTRUMENTS

INSTRUMENTS
DENTAIRES

INSTRUMENTOS DE
ODONTOLOGÍA

STRUMENTI
DENTALI

ZEPF[®]
α
INSTRUMENTS
TUTTLINGEN
GERMANY

ZEPF MEDICAL INSTRUMENTS GMBH
GUNNINGERSTR. 21 · D-78606 SEITINGEN-OBERFLACHT
P.O.B. 4805 · D-78513 TUTTLINGEN
FON: +49 (0) 7464 / 985060
FAX: +49 (0) 7464 / 9850666
E-MAIL: info@zepf-medical-instruments.de
www.zepf-medical-instruments.de

To Order: Contact Co