

KNOCHENCHIRURGIE

BONE SURGERY

CHIRURGIE OSSEUSE

CIRUGÍA ÓSEA

CHIRURGIA OSSEA

Distributed in New Zealand by:



Cooper Medical Limited
57 Mahunga Drive
Mangere Bridge
Auckland 2022

ZEPF®
α
INSTRUMENTS

Hohlmeisselzangen
 Bone Rongeurs
 Pincés-gouges
 Pinzas gubias
 Pinze sgorbie

KNOCHENCHIRURGIE

BONE SURGERY

CHIRURGIE OSSEUSE

CIRUGÍA ÓSEA

CHIRURGIA OSSEA



cm FRIEDMANN VICKERS
 14,0 32-1000-14



cm FRIEDMANN mini
 12,0 32-1001-12



cm FRIEDMANN
 14,0 32-1001-14



cm FRIEDMANN
 14,0 32-1002-14

cm FRIEDMANN
 15,0 32-1002-15

ZEPF[®]

 INSTRUMENTS

32-1000-14

32.2

Hohlmeisselzangen
 Bone Rongeurs
 Pincés-gouges
 Pinzas gubias
 Pinze sgorbie



cm CLEVELAND Fig. 4
 14,0 32-1003-14



cm CLEVELAND Fig. 4A
 17,0 32-1005-17

KNOCHENCHIRURGIE

BONE SURGERY

CHIRURGIE OSSEUSE

CIRUGÍA ÓSEA

CHIRURGIA OSSEA



cm MEAD Fig. 1A
 16,5 32-1007-16



cm MEAD Fig. 2A
 16,5 32-1009-16



cm GLASGOW
 14,5 32-1011-14

ZEPF[®]

 INSTRUMENTS

32-1011-14

32.3

Hohlmeisselzangen
 Bone Rongeurs
 Pincés-gouges
 Pinzas gubias
 Pinze sgorbie

KNOCHENCHIRURGIE

BONE SURGERY

CHIRURGIE OSSEUSE

CIRUGÍA ÓSEA

CHIRURGIA OSSEA



cm COHEN
 14,0 32-1013-14



cm BLUMENTHAL
 15,5 32-1105-15



cm BLUMENTHAL
 15,5 32-1107-15

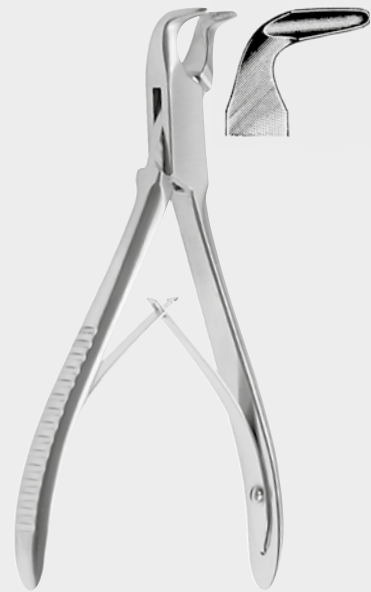

cm BLUMENTHAL
 15,5 32-1109-15

ZEPF[®]
INSTRUMENTS

32-1013-14

32.4



cm LUER
15,0 32-1301-15

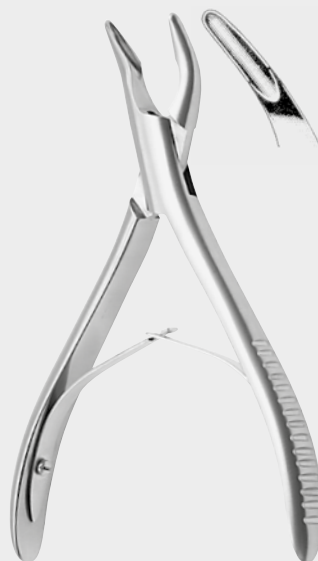

cm LUER
15,0 32-1303-15



cm LUER
15,0 32-1305-15

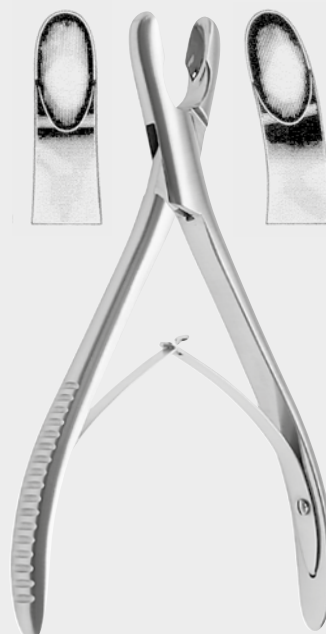

cm LUER
17,0 32-1306-17 32-1307-17

Hohlmeisselzangen
Bone Rongeurs
Pinces-gouges
Pinzas gubias
Pinze sgorbie

KNOCHENCHIRURGIE

BONE SURGERY

CHIRURGIE OSSEUSE

CIRUGÍA ÓSEA

CHIRURGIA OSSEA

ZEPF[®]
α
INSTRUMENTS

32-1307-17

32.5

Hohlmeisselzangen
 Bone Rongeurs
 Pincés-gouges
 Pinzas gubias
 Pinze sgorbie

KNOCHENCHIRURGIE

BONE SURGERY

CHIRURGIE OSSEUSE

CIRUGÍA ÓSEA

CHIRURGIA OSSEA



cm BANE 4,0 mm
 18,0 32-1315-18



cm CLOVIS VINCENT
 21,0 32-1381-21
 26,0 32-1381-26



cm CLOVIS VINCENT
 21,0 32-1383-21
 26,0 32-1383-26



cm ADSON
 20,0 32-1402-20 32-1403-20



32-1315-18

32.6

Hohlmeisselzangen
 Bone Rongeurs
 Pinces-gouges
 Pinzas gubias
 Pinze sgorbie



cm OLIVECRONA
 20,0 32-1407-20



cm LEMPERT JUERS 3,0 mm
 20,0 32-1499-20

KNOCHENCHIRURGIE

BONE SURGERY

CHIRURGIE OSSEUSE

CIRUGÍA ÓSEA

CHIRURGIA OSSEA



cm LEMPERT
 16,0 32-1500-16 32-1501-16



cm LEMPERT
 18,5 32-1504-18 32-1505-18



cm HAKANSSON
 17,0 32-1507-17



32-1507-17

32.7

Hohlmeisselzangen
Bone Rongeurs
Pincés-gouges
Pinzas gubias
Pinze sgorbie

KNOCHENCHIRURGIE

BONE SURGERY

CHIRURGIE OSSEUSE

CIRUGÍA ÓSEA

CHIRURGIA OSSEA



cm	BEYER
18,0	32-1509-18



cm	BEYER	mm
17,0	32-1601-02	2,0
17,0	32-1601-03	3,0



cm	BACON
20,0	32-1605-20

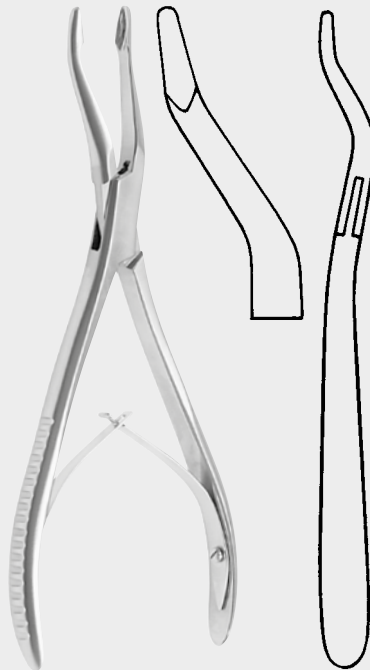

cm	JANSEN
19,0	32-1607-19



cm	GULEKE
20,5	32-1609-20

ZEPF[®]
α
INSTRUMENTS

32-1509-18

32.8



cm ST. GEORG
22,0 32-1611-22



STELLBRINK
32-1615-17 - 32-1617-17

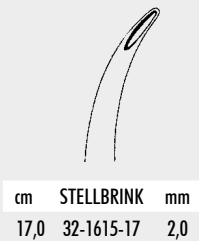

cm STELLBRINK mm
17,0 32-1615-17 2,0



cm STELLBRINK mm
17,0 32-1617-17 2,0

Hohlmeisselzangen
Bone Rongeurs
Pinces-gouges
Pinzas gubias
Pinze sgorbie

KNOCHENCHIRURGIE

BONE SURGERY

CHIRURGIE OSSEUSE

CIRUGÍA ÓSEA

CHIRURGIA OSSEA



cm SICARD
24,0 32-1612-24



cm SICARD 3,0 mm
19,0 32-1619-19



32-1619-19

32.9

Hohlmeisselzangen
 Bone Rongeurs
 Pincés-gouges
 Pinzas gubias
 Pinze sgorbie

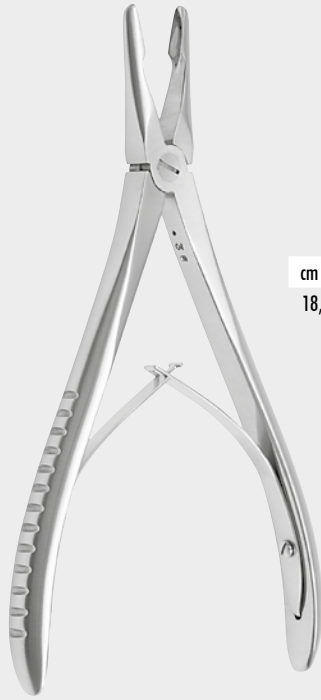

cm JANSEN
 18,0 32-1620-18

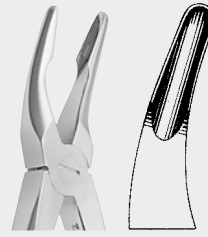

cm JANSEN
 18,0 32-1621-18

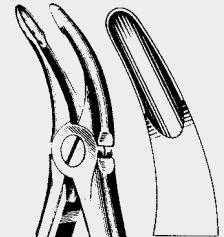

cm JANSEN
 18,0 32-1623-18

KNOCHENCHIRURGIE

JANSEN
 32-1620-18 - 32-1623-18

BONE SURGERY

CHIRURGIE OSSEUSE

CIRUGÍA ÓSEA

CHIRURGIA OSSEA

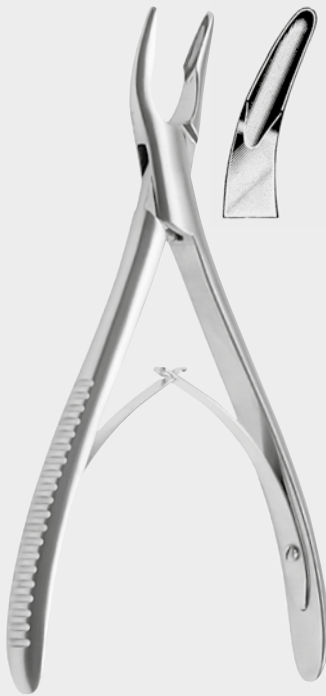

cm HARTMANN
 18,5 32-1631-18



cm UNIVERSAL
 13,5 32-1635-13



cm PENNYBACKER mm
 20,5 32-1638-20 4,0



cm FALCONER mm
20,5 32-1641-20 6,0



cm TROTTER mm
20,5 32-1643-20 10,0



cm WILMS
20,5 32-1645-20

Hohlmeisselzangen
Bone Rongeurs
Pincés-gouges
Pinzas gubias
Pinze sgorbie

KNOCHENCHIRURGIE

BONE SURGERY

CHIRURGIE OSSEUSE

CIRUGÍA ÓSEA

CHIRURGIA OSSEA

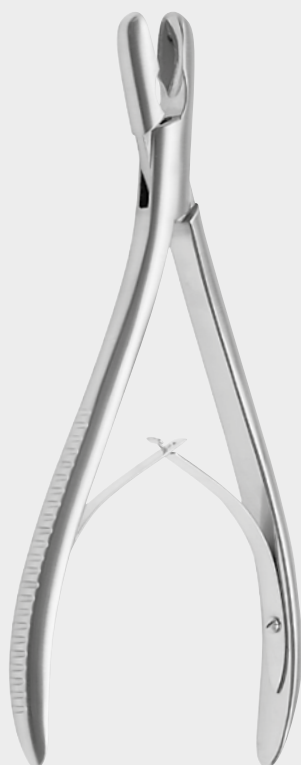

cm NORTHFIELD
20,5 32-1647-20



cm KLEINERT KUTZ
15,0 32-1689-15



cm BEYER
18,0 32-2001-18

ZEPF®
INSTRUMENTS

32-2001-18

32.11

Hohlmeisselzangen
 Bone Rongeurs
 Pincés-gouges
 Pinzas gubias
 Pinze sgorbie

KNOCHENCHIRURGIE

BONE SURGERY

CHIRURGIE OSSEUSE

CIRUGÍA ÓSEA

CHIRURGIA OSSEA



cm GEIGER 3,0 mm
 15,0 32-2003-15



cm ZAUFAL-JANSEN
 18,0 32-2005-18



cm	mm	BÖHLER (RUSKIN MINI)	
15,0	2	32-2100-15	32-2101-15
15,0	3	32-2102-15	32-2103-15



cm	RUSKIN		
18,0	32-2106-18	32-2107-18	32-2111-18



cm	RUSKIN	
23,0	32-2108-23	32-2109-23



32-2003-15

32.12

Hohlmeisselzangen
 Bone Rongeurs
 Pincés-gouges
 Pinzas gubias
 Pinze sgorbie

KNOCHENCHIRURGIE

BONE SURGERY

CHIRURGIE OSSEUSE

CIRUGÍA ÓSEA

CHIRURGIA OSSEA



32-2305-23

32.13



cm RÖTTGEN-RUSKIN 
 24,0 32-2121-24



nn FULTON 
 15,0 x 16,0 32-2123-24
 24,0 cm



cm  STILLE-LUER 
 22,0 32-2300-22 32-2301-22
 26,0 32-2300-26 32-2301-26

seitwärts
 side curved
 courbe latéralement
 curvo lateralmente
 curvo laterale



cm STILLE LUER 
 23,0 32-2302-23
 27,0 32-2302-27



cm STILLE LUER 
 23,0 32-2303-23
 27,0 32-2303-27



cm STILLE-LUER (DUCKBILL)
 23,0 32-2305-23



Hohlmeisselzangen
 Bone Rongeurs
 Pincés-gouges
 Pinzas gubias
 Pinze sgorbie

KNOCHENCHIRURGIE

BONE SURGERY

CHIRURGIE OSSEUSE

CIRUGÍA ÓSEA

CHIRURGIA OSSEA



cm	STILLE-RUSKIN
23,0	32-2307-23

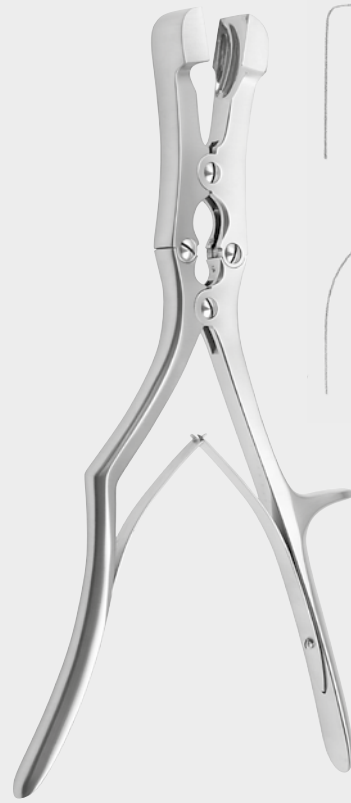

Fig.	SAUERBRUCH 30,0 cm
1	32-2401-30
2	32-2403-30

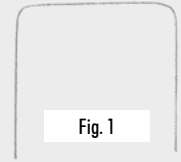

Fig. 1

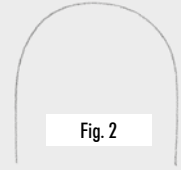

Fig. 2

seitwärts
 side curved
 courbe latéralement
 curvo lateralmente
 curvo laterale



mm	LEKSELL (STILLE)
5,0	32-2407-23



mm	LEKSELL (STILLE)
8,0	32-2405-23



mm	LEKSELL (STILLE), 23,0 cm
8,0	32-2405-23
5,0	32-2407-23



mm	LEKSELL (STILLE)
5,0	32-2409-05



mm	LEKSELL (STILLE)
8,0	32-2409-08



mm	LEKSELL (STILLE), 23,0 cm
5,0	32-2409-05
8,0	32-2409-08



32-2307-23

32.14

Hohlmeisselzangen
 Bone Rongeurs
 Pinces-gouges
 Pinzas gubias
 Pinze sgorbie



» SCAGLIETTI «
 32-2501-26 26,0 cm 32-2503-26



cm FRYKHOLM
 24,0 32-2505-24

KNOCHENCHIRURGIE

BONE SURGERY

CHIRURGIE OSSEUSE

CIRUGÍA ÓSEA

CHIRURGIA OSSEA



2,0 mm 32-2509-02



3,0 mm 32-2509-03



4,0 mm 32-2509-04



mm	ECHLIN 23,0 cm
2,0	32-2509-02
3,0	32-2509-03
4,0	32-2509-04



cm	SEMB
22,5	32-2601-22
27,0	32-2601-27



32-2601-08

32.15

Hohlmeisselzangen
Bone Rongeurs
Pinces-gouges
Pinzas gubias
Pinze sgorbie

KNOCHENCHIRURGIE

BONE SURGERY

CHIRURGIE OSSEUSE

CIRUGÍA ÓSEA

CHIRURGIA OSSEA



3,0 mm 32-2602-24



3,0 mm 32-2603-24



3,0 mm 32-2605-24



SMITH PETERSEN 24,0 cm
3,0 mm 32-2602-24 - 32-2605-24



cm MARQUARDT
20,0 32-2611-20



cm MAYFIELD
17,0 32-2613-17

Hohlmeisselzangen
 Bone Rongeurs
 Pincés-gouges
 Pinzas gubias
 Pinze sgorbie

KNOCHENCHIRURGIE

BONE SURGERY

CHIRURGIE OSSEUSE

CIRUGÍA ÓSEA

CHIRURGIA OSSEA



32-2625-08

32.17



cm SYPERT
 35,0 32-2623-03 - 32-2623-08



3,0 mm 32-2623-03



5,0 mm 32-2623-05



8,0 mm 32-2623-08

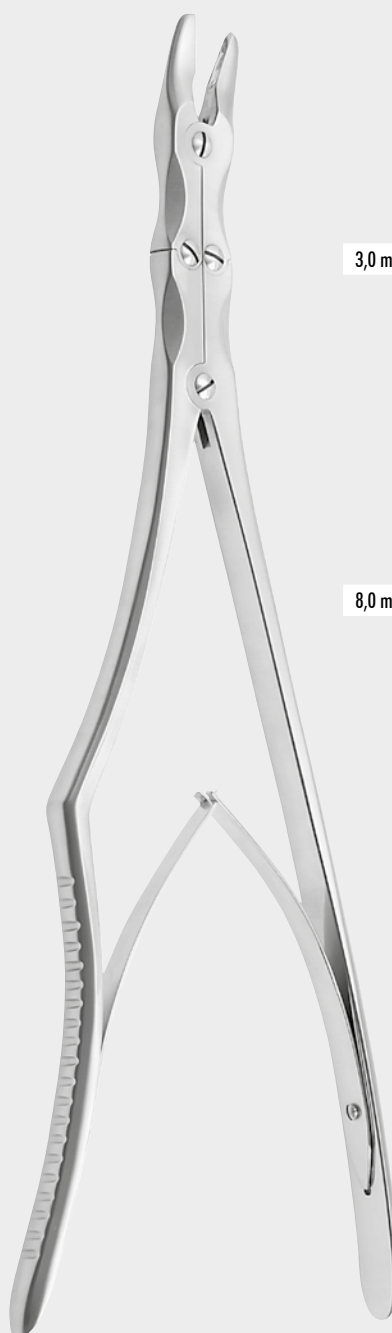

cm DALE
 35,0 32-2625-03 - 32-2625-08



3,0 mm 32-2625-03



8,0 mm 32-2625-08

Knochensplitterzangen
 Bone Cutting Forceps
 Pinces coupantes à os
 Pinzas cortantes para huesos
 Cesoie per ossa

KNOCHENCHIRURGIE

BONE SURGERY

CHIRURGIE OSSEUSE

CIRUGÍA ÓSEA

CHIRURGIA OSSEA



cm	STAMM
15,0	32-2701-15



cm	
12,0	32-2703-12



cm	—	LISTON	—
14,0	32-2704-14		32-2705-14
17,0	32-2704-17		32-2705-17
19,0	32-2704-19		32-2705-19
22,0	32-2704-22		32-2705-22

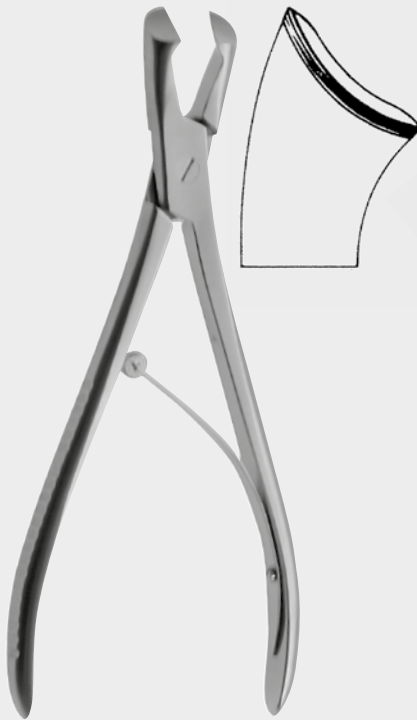

cm	MARKWALDER
20,0	32-2710-20



cm	CLEVELAND Fig. 5
17,0	32-2721-17



cm	CLEVELAND Fig. 5S
15,0	32-2723-15

Knochensplitterzangen
 Bone Cutting Forceps
 Pinces coupantes à os
 Pinzas cortantes para huesos
 Cesoie per ossa



cm CLEVELAND (GARDNER) Fig. 6
 16,0 32-2727-16



cm COTTLE-KAZANJIAN
 19,0 32-2782-19



cm CLEVELAND Fig. 6A
 16,0 32-2725-16

KNOCHENCHIRURGIE

BONE SURGERY

CHIRURGIE OSSEUSE

CIRUGÍA ÓSEA

CHIRURGIA OSSEA

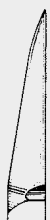

32-2802-15



32-2803-15



cm KLEINERT-KUTZ
 15,0 32-2802-15 - 32-2803-15

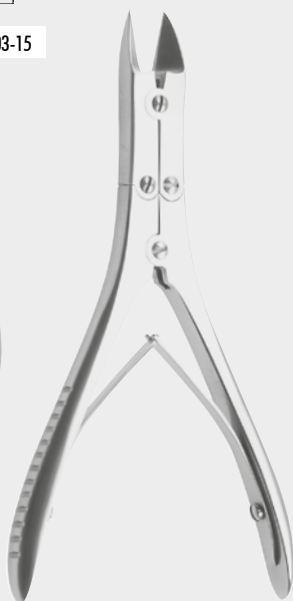

cm BÖHLER (WALTON LISTON)
 15,0 32-2804-15 32-2805-15



cm McINDOE
 17,5 32-2807-17



cm RUSKIN-LISTON
 18,5 32-2808-18 32-2809-18



ZEPF®
 INSTRUMENTS

32-2809-18

32.19

Knochensplitterzangen
 Bone Cutting Forceps
 Pincas coupantes à os
 Pinzas cortantes para huesos
 Cesoie per ossa

KNOCHENCHIRURGIE

BONE SURGERY

CHIRURGIE OSSEUSE

CIRUGÍA ÓSEA

CHIRURGIA OSSEA



cm RUSKIN-ROWLAND
 18,0 32-2820-18



cm RUSKIN-ROWLAND
 18,0 32-2821-18



cm
 17,0 32-2833-17



cm STILLE-LISTON
 23,5 32-2901-23
 27,0 32-2900-27 32-2901-27

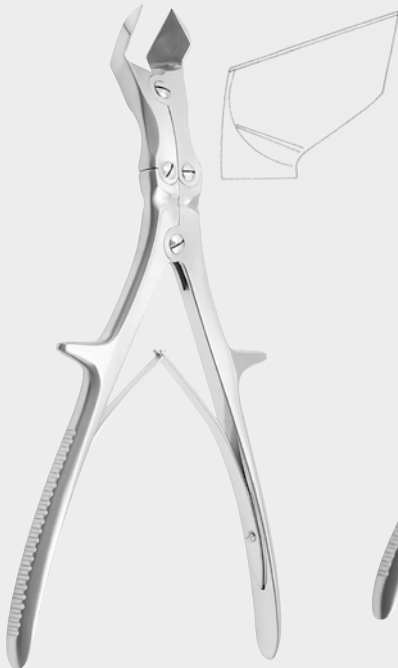

cm STILLE-HORSLEY
 27,0 32-2903-27

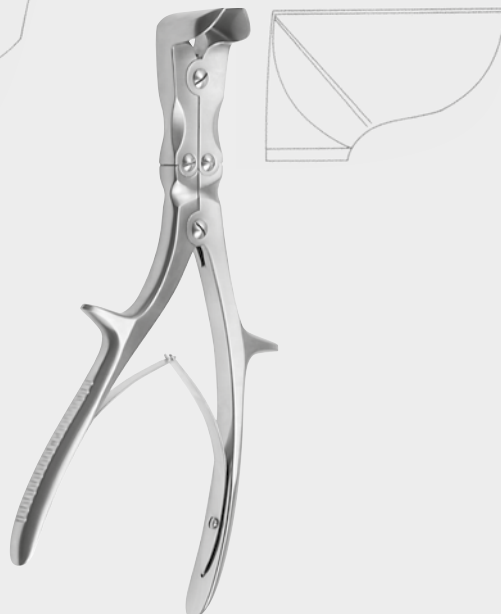

cm SEMB
 24,0 32-2905-24



cm STILLE LISTON
 27,0 32-2917-27

Knochenhaltezangen
 Bone Holding Forceps
 Daviers porte-os
 Pinzas para huesos
 Tenaglie per ossa

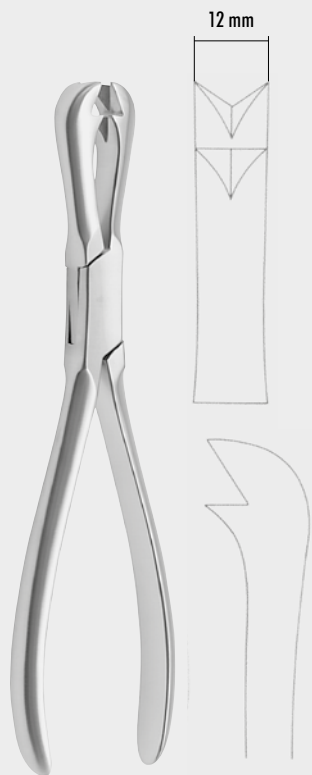

cm FERGUSSON
 21,0 32-3600-21



cm LANGENBECK
 21,0 32-3602-21

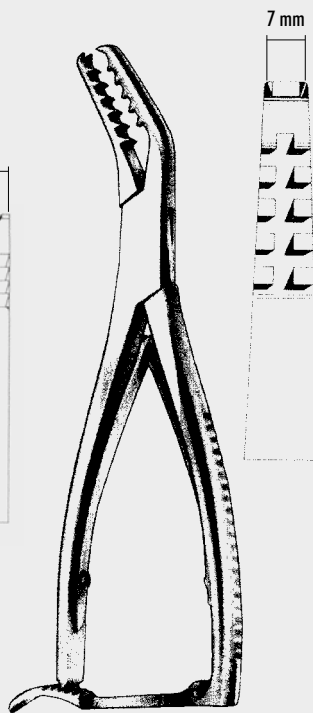

cm SEMB
 19,0 32-3603-19



cm SEMB
 19,0 32-3605-19

KNOCHENCHIRURGIE

BONE SURGERY

CHIRURGIE OSSEUSE

CIRUGÍA ÓSEA

CHIRURGIA OSSEA



cm FARABEUF
 23,0 32-3606-23
 26,0 32-3606-26



cm FARABEUF-LAMBOTTE
 26,0 32-3608-26



cm FARABEUF-LAMBOTTE
 22,0 32-3700-22
 27,0 32-3700-27
 30,0 32-3700-30

ZEPF®
 &
 INSTRUMENTS

32-3700-30

32.21



Knochenhaltezaugen
 Bone Holding Forceps
 Daviers porte-os
 Pinzas para huesos
 Tenaglie per ossa



cm	LAMBOTTE
19,0	32-3703-19
23,0	32-3703-23
26,0	32-3703-26



cm	BISHOP
23,0	32-3704-23

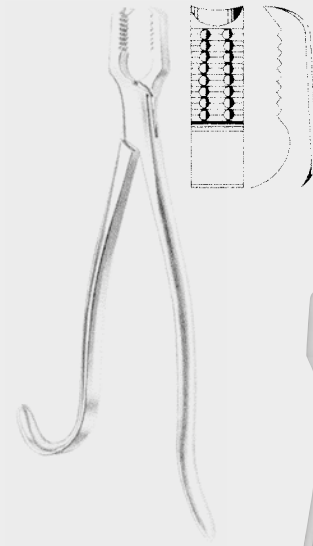

cm	KERN
15,0	32-3708-15
17,0	32-3708-17
21,0	32-3708-21



cm	KERN
15,0	32-3800-15
17,0	32-3800-17
21,0	32-3800-21

KNOCHENCHIRURGIE

BONE SURGERY

CHIRURGIE OSSEUSE

CIRUGÍA ÓSEA

CHIRURGIA OSSEA



cm	LANE KERN
24,0	32-3802-24

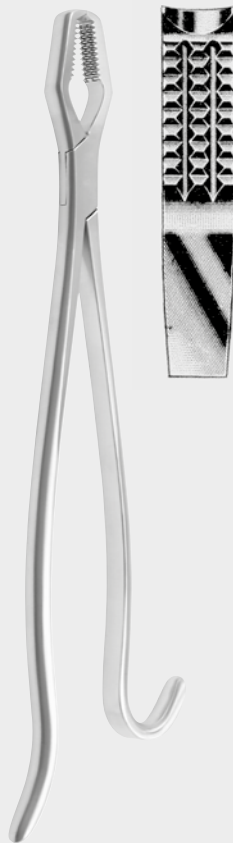

cm	LANE
33,0	32-3802-33
45,0	32-3802-45

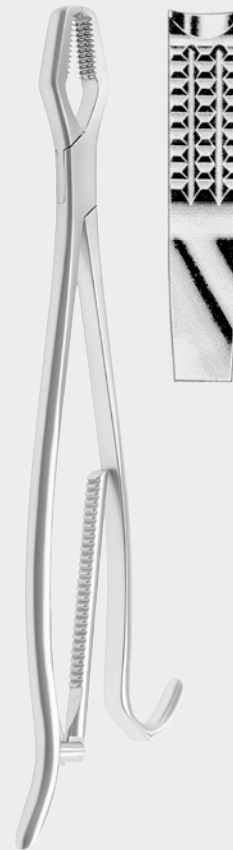

cm	LANE
33,0	32-3804-33
45,0	32-3804-45



cm	LANE
20,0	32-3806-20



32-3702-22

32.22



cm FROSC
18,0 32-3810-18

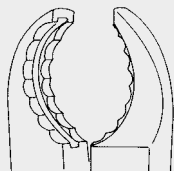

cm ULRICH
23,0 32-3812-23 32-3813-23

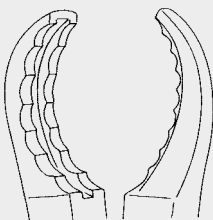

cm ULRICH
25,0 32-3812-25 32-3813-25

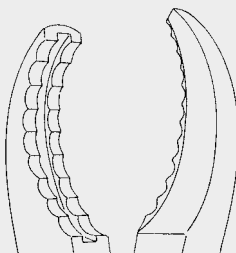

cm ULRICH
28,0 32-3812-28 32-3813-28



ULRICH
32-3812-23 - 32-3812-28



ULRICH
32-3813-23 - 32-3813-28



cm HEY GROVES
20,0 32-3820-20
25,0 32-3820-25
30,0 32-3820-30

Knochenhalte­zangen
Bone Holding Forceps
Pinças porte-os
Pinzas para huesos
Tenaglie per ossa

KNOCHENCHIRURGIE

BONE SURGERY

CHIRURGIE OSSEUSE

CIRUGÍA ÓSEA

CHIRURGIA OSSEA

ZEPF®
INSTRUMENTS

32-3820-30

32.23



Knochenhaltezangen, selbstzentrierend
 Bone Holding Forceps, Self-centering
 Daviers porte-os, autocentrants
 Pinzas para huesos, autocentrantes
 Tenaglie per ossa, autocentranti



32-3901-15 - 32-3901-28

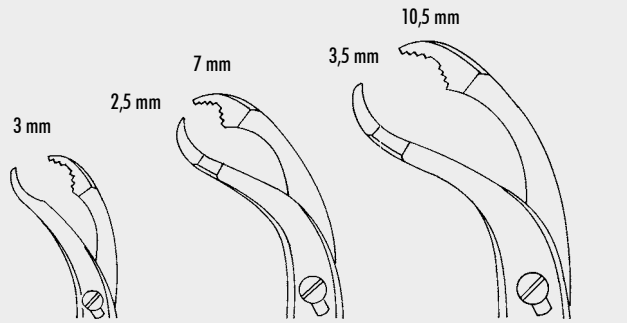

cm
15,0 32-3901-15

cm
19,0 32-3901-19

cm
24,0 32-3901-24

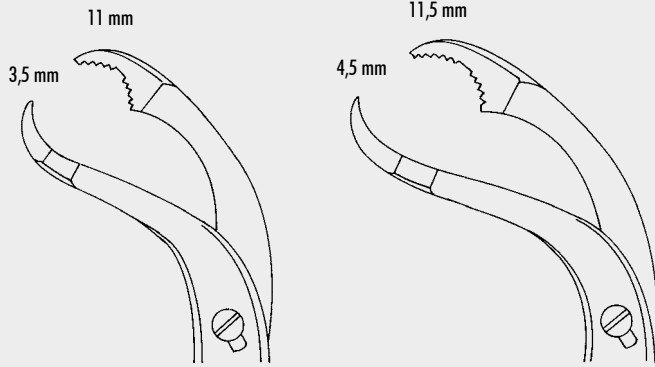

cm
26,0 32-3901-26

cm
28,0 32-3901-28

KNOCHENCHIRURGIE

BONE SURGERY

CHIRURGIE OSSEUSE

CIRUGÍA ÓSEA

CHIRURGIA OSSEA

Knochenhaltezangen
 Bone Holding Forceps
 Daviers porte-os
 Pinzas para huesos
 Tenaglie per ossa



VERBRUGGE
 32-3905-17 - 32-3905-27

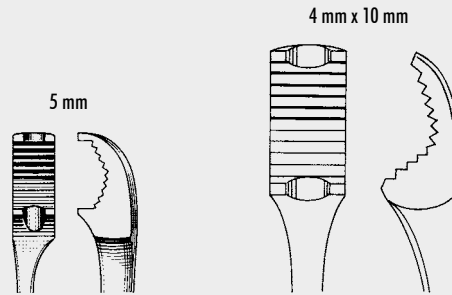

cm
17,5 32-3905-17

cm
25,0 32-3905-25

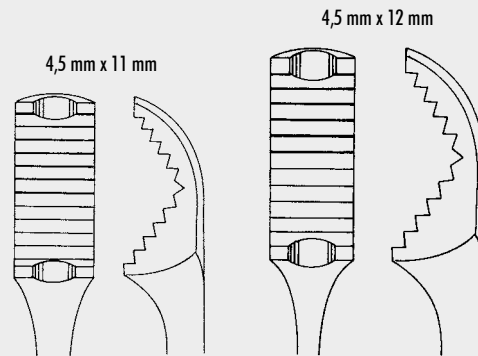

cm
26,0 32-3905-26

cm
27,0 32-3905-27



cm WELLER
 20,0 32-3991-20



32-3901-15

32.24



3:4

cm BIRCHER
20,0 32-4000-20



3:4

cm BIRCHER
20,0 32-4001-20



cm LEWIN
17,5 32-4002-17

Knochenhalte-, Repositionszangen
Bone Holding, Reposition Forceps
Daviers porte-os
Pinzas para huesos
Tenaglie per ossa

KNOCHENCHIRURGIE

BONE SURGERY

CHIRURGIE OSSEUSE

CIRUGÍA ÓSEA

CHIRURGIA OSSEA



cm BIRCHER-GANSKE
20,0 32-4004-20 32-4005-20 32-4006-20



2:2

cm DINGMANN
19,0 32-4007-19



2:2

cm DINGMANN modif.
19,0 32-4008-19



32-4008-19

32.25

Repositions-, Knorpelasszangen
 Reposition, Cartilage Grasping Forceps
 Daviers à os et à cartilage
 Pinzas para huesos y cartilagos
 Pinze per ossa e cartilagini

KNOCHENCHIRURGIE

BONE SURGERY

CHIRURGIE OSSEUSE

CIRUGÍA ÓSEA

CHIRURGIA OSSEA



cm
9,5 32-4009-09



cm
13,5 32-4009-13



cm
13,5 32-4011-13



cm HAASE
16,5 32-4013-16



cm
16,0 32-4014-16

ZEPF[®]

INSTRUMENTS

32-4009-09

32.26

Repositions-, Knorpelfasszangen
 Reposition, Cartilage Grasping Forceps
 Daviers à os et à cartilage
 Pinzas para huesos y cartilagos
 Pinze per osso e cartilagini



cm TUCKER
 19,0 32-4015-19



cm TUCKER
 16,0 32-4016-16



cm
 14,0 32-4021-14

KNOCHENCHIRURGIE

BONE SURGERY

CHIRURGIE OSSEUSE

CIRUGÍA ÓSEA

CHIRURGIA OSSEA



cm
 12,0 32-4023-12



cm MC LEARIE
 18,5 32-4025-18



cm
 16,0 32-4030-16
 22,0 32-4030-22
 24,0 32-4030-24

ZEPF®
 INSTRUMENTS

32-4030-24

32.27

Repositions-, Knorpelasszangen
 Reposition, Cartilage Grasping Forceps
 Daviers à os et à cartilage
 Pinzas para huesos y cartilagos
 Pinze per ossa e cartilagini

KNOCHENCHIRURGIE

BONE SURGERY

CHIRURGIE OSSEUSE

CIRUGÍA ÓSEA

CHIRURGIA OSSEA



cm
14,0 32-4034-14

cm HERZ
23,0 32-4051-23

cm JÄGER
23,5 32-4053-23

cm WELLER
20,0 32-4057-20



cm MARTIN
16,0 32-4100-16
19,0 32-4100-19



cm REILL
17,0 32-4101-17



cm BURNS
18,0 32-4102-18



cm
20,0 32-4103-20



cm REILL
17,0 32-4104-17

Repositionszange, Sequesterzangen
Resposition Forceps, Sequestrum Forceps
Daviers à os et à séquestres
Pinzas para huesos y para sequestros
Pinze per ossa e per sequestri

KNOCHENCHIRURGIE

BONE SURGERY

CHIRURGIE OSSEUSE

CIRUGÍA ÓSEA

CHIRURGIA OSSEA

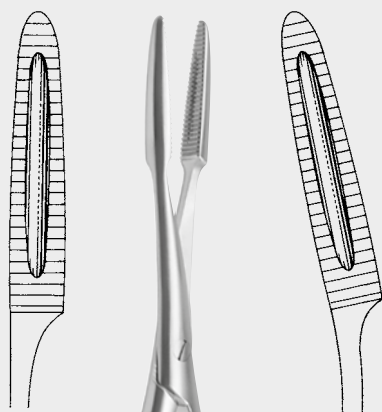

cm
20,0 32-4200-20 32-4201-20

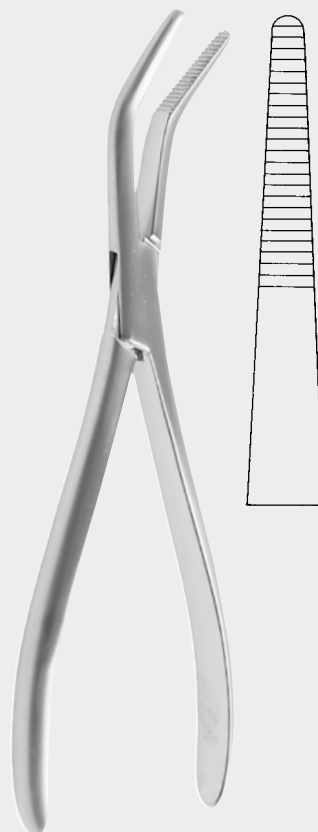

cm VAN BUREN
23,0 32-4203-23



32-4003-23

32.29

Repositionszange, Sequesterzangen
 Reposition Forceps, Sequestrum Forceps
 Daviers à os et à séquestres
 Pinzas para huesos y para sequestrós
 Pinze per ossa e per sequestrí

KNOCHENCHIRURGIE

BONE SURGERY

CHIRURGIE OSSEUSE

CIRUGÍA ÓSEA

CHIRURGIA OSSEA



cm	OLLIER
16,0	32-4250-16
18,0	32-4250-18
23,0	32-4250-23



cm	OLLIER
19,0	32-4252-19
23,0	32-4252-23
27,0	32-4252-27



cm	
24,0	32-4260-24



cm	
19,0	32-4261-19



cm	
19,0	32-4261-24



32-4250-16

32.30

Repositionszange, Sequesterzangen
 Reposition Forceps, Sequestrum Forceps
 Daviers à os et à séquestres
 Pinzas para huesos y para sequestros
 Pinze per ossa e per sequestri

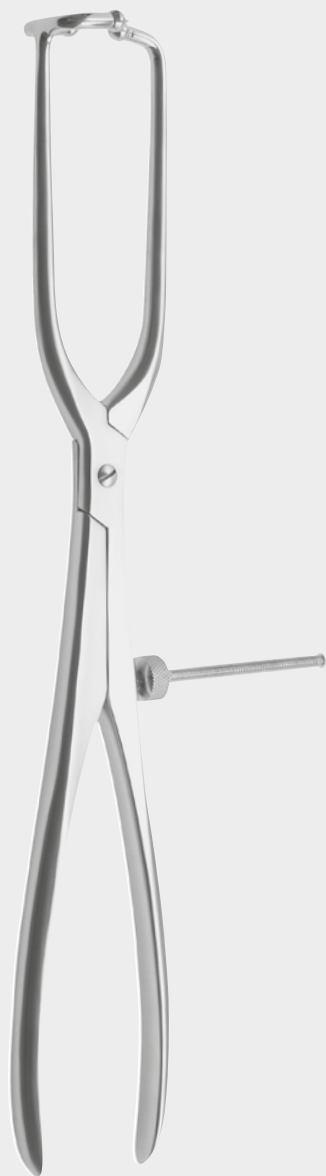

cm
 40,0 32-4264-40

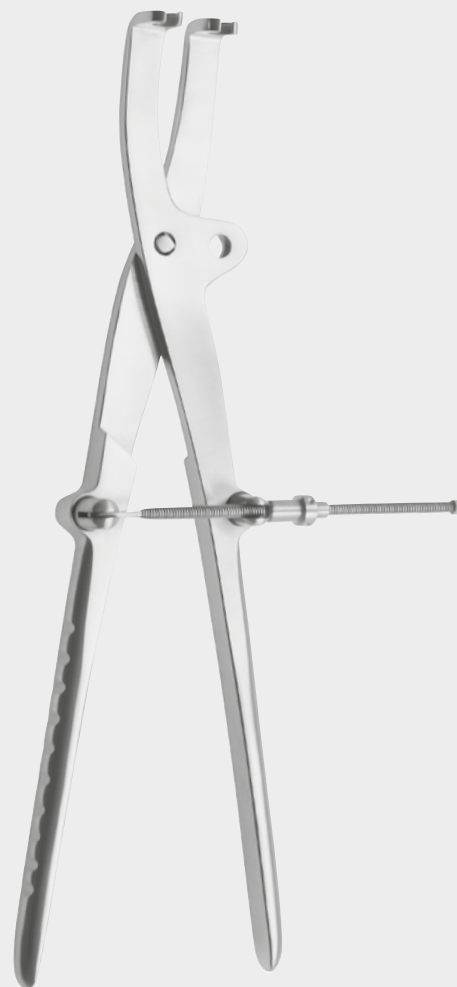

cm
 34,5 32-4266-34

KNOCHENCHIRURGIE

BONE SURGERY

CHIRURGIE OSSEUSE

CIRUGÍA ÓSEA

CHIRURGIA OSSEA

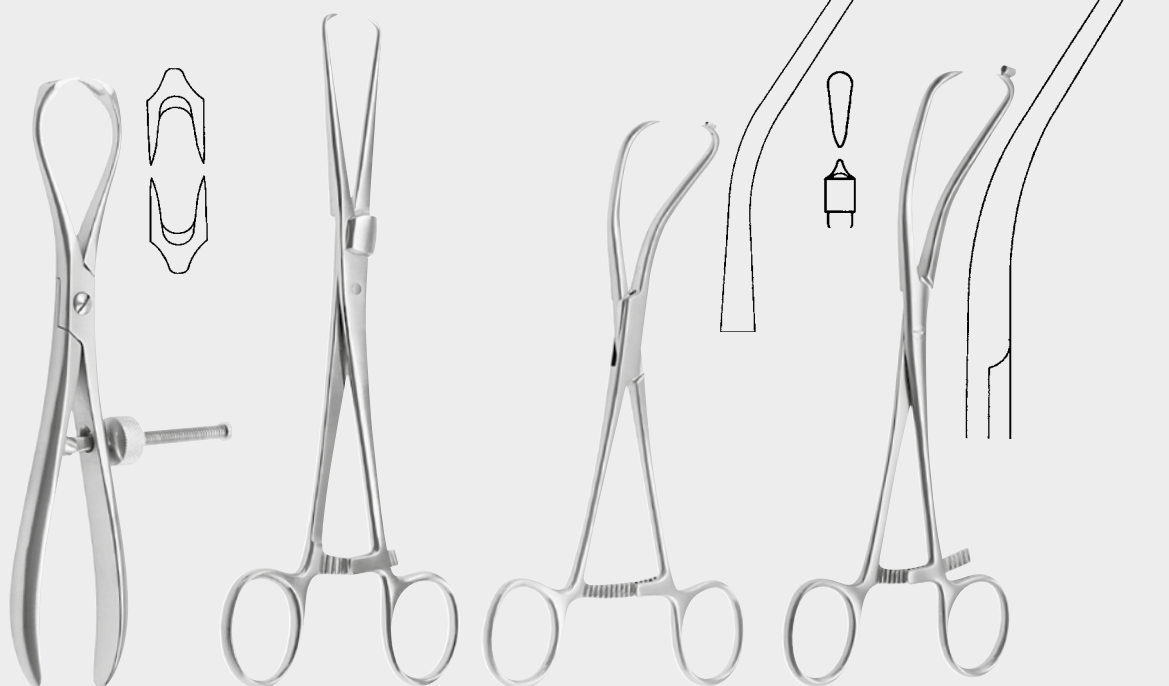

cm
 18,0 32-4302-18

cm **CODIVILLA**
 20,0 32-4310-20 32-4311-20

cm **MEYER**
 17,0 32-4321-17

cm **MEYER**
 20,5 32-4321-20

max. ø 2,0 mm

max. ø 1,0 mm

Patellazange, Repositionszangen
 mit Bohrbüchse
 Patella Forceps, Reposition Forceps
 with drill guide
 Pince à saisir la patella, daviers
 avec douille guide-foret
 Pinza de patella, pinza
 con guías de brocas
 Pinza per la patella, pinze
 con guida-trapano



32-4321-20

32.31

Knochenhalteklammern
Bone Holding Clamps
Daviers à os
Clamps para huesos
Tenaglie per ossa

KNOCHENCHIRURGIE

BONE SURGERY

CHIRURGIE OSSEUSE

CIRUGÍA ÓSEA

CHIRURGIA OSSEA



cm	LOWMAN
13,0	32-4401-13
18,5	32-4401-18
20,0	32-4401-20
22,0	32-4401-22



cm	LOWMAN HOGLUND
18,0	32-4402-18

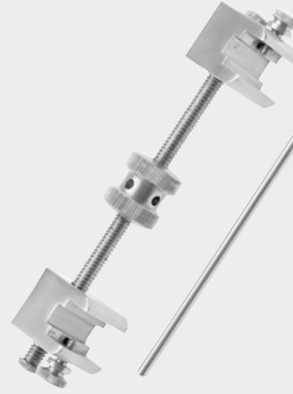

GERSTER
32-4404-15



PARHAM
32-4406-24



cm	PARHAM
18,0	32-4408-18
30,0	32-4408-30



32-4500-01	f. Erwachsene
	adult size
	p. adultes
	p. adultos
	p. adulti



32-4500-02	f. Kinder
	child size
	p. enfants
	p. niños
	p. bambini

Bleihand - Lead Hand Splint - Main en plomb
Manopla de plomo - Manopola in piombo

32-4502-00	Stahl
	Stainless Steel
	acier inox
	acero inox
	acciaio inox

ZEPF[®]
α
INSTRUMENTS

32-4401-13

32.32

Instrumente für Sehnen
Tendon Instruments
Instruments à tendons
Instrumentos para tendones
Strumenti per tendini

KNOCHENCHIRURGIE

BONE SURGERY

CHIRURGIE OSSEUSE

CIRUGÍA ÓSEA

CHIRURGIA OSSEA



ø mm	cm
1,5	32-4510-15 10,0



ø mm	cm
2,5	32-4510-25 10,0



ø mm	cm
4,5	32-4510-45 10,0



ø mm	cm
5,5	32-4510-55 10,0

LARSEN
32-4510-15 - 32-4510-55



cm STEINMANN
16,0 32-4512-16

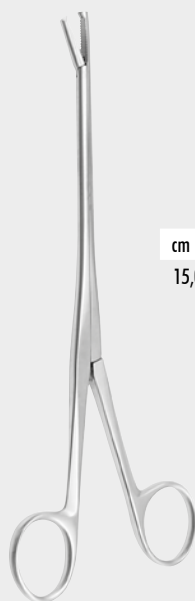

1:2



cm
15,0 32-4514-15

1:2



cm
19,0 32-4514-19

1:2



cm
24,0 32-4514-24

BRAND
32-4514-15 - 32-4514-24



32-4514-24

32.33



Sehnen-Instrumente
Tendon Instruments
Instruments à tendons
Instrumentos para tendones
Strumenti per tendini

KNOCHENCHIRURGIE

BONE SURGERY

CHIRURGIE OSSEUSE

CIRUGÍA ÓSEA

CHIRURGIA OSSEA

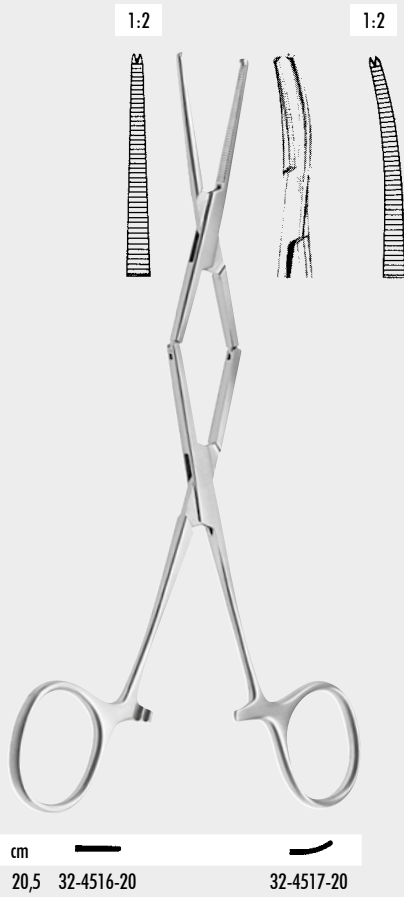

cm 20,5 32-4516-20 32-4517-20



cm CAROLL 11,0 32-4521-11

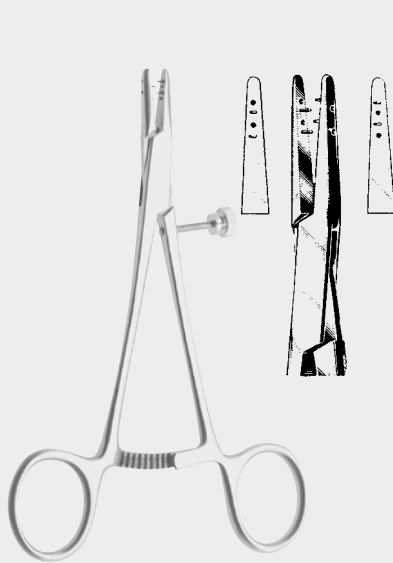

cm 13,0 32-4524-13

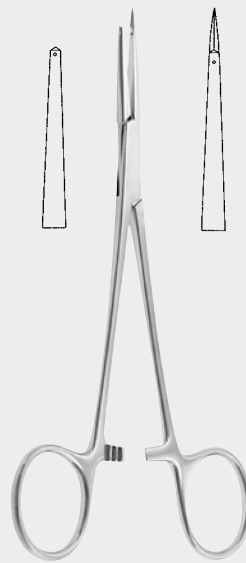

cm 15,0 32-4528-15

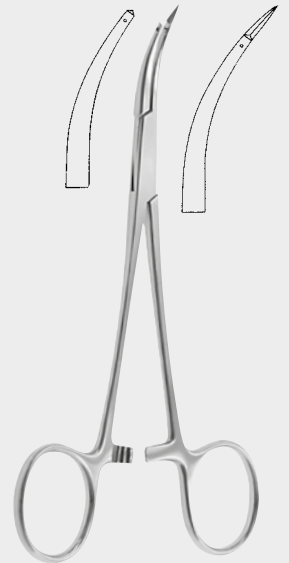

cm 15,0 32-4529-15



32-4516-20

32.34

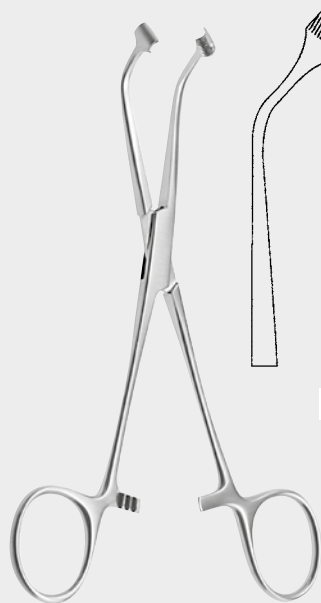

cm HERZ
15,5 32-4541-15 - 32-4543-15



32-4541-15



32-4543-15

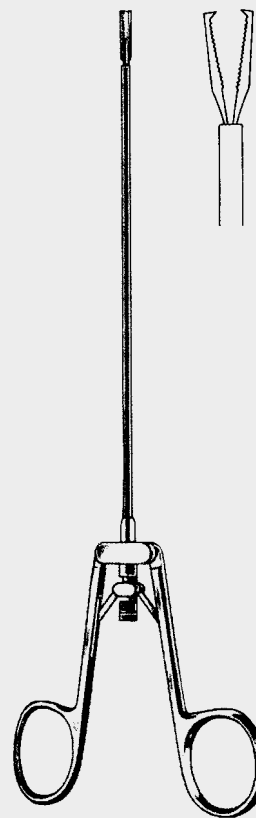

cm KLEINERT-KUTZ
20,0 32-4552-20

Sehnen-Fasszangen
Tendon Seizing Forceps
Pincès à saisir les tendons
Pinzas para agarrar tendones
Pinze afferratendini

KNOCHENCHIRURGIE

BONE SURGERY

CHIRURGIE OSSEUSE

CIRUGÍA ÓSEA

CHIRURGIA OSSEA



rund
round
rond
redonda
rotondo

Fig. 1
32-4602-02 - 32-4602-14

Fig. 1	ø mm	Fig. 2
32-4602-02	2,0	32-4603-02
32-4602-04	4,0	32-4603-04
32-4602-06	6,0	32-4603-06
32-4602-08	8,0	32-4603-08
32-4602-10	10,0	32-4603-10
32-4602-12	12,0	32-4603-12
32-4602-14	14,0	32-4603-14



oval
ovale

Fig. 2
32-4603-02 - 32-4603-14

Scharfe Löffel
Bone Curettes
Cuillères tranchantes
Cucharillas cortantes
Curette taglienti



32-4603-14

32.35



Scharfe Löffel
Bone Curettes
Cuillères tranchantes
Cucharillas cortantes
Curette taglienti

KNOCHENCHIRURGIE

BONE SURGERY

CHIRURGIE OSSEUSE

CIRUGÍA ÓSEA

CHIRURGIA OSSEA

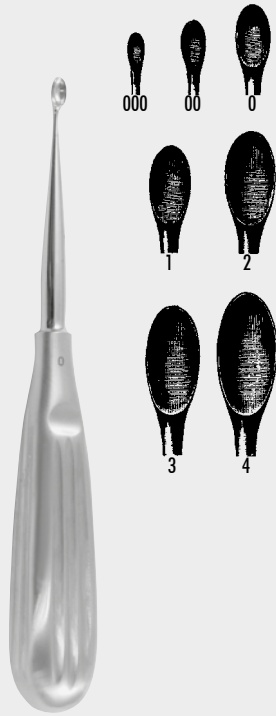

SCHUDE 17,0 cm
32-4607-97 - 32-4608-04

SCHUDE	Fig.	VOLKMANN
	0000	32-4609-96
32-4607-97	000	32-4609-97
32-4607-98	00	32-4609-98
32-4608-00	0	32-4700-00
32-4608-01	1	32-4700-01
32-4608-02	2	32-4700-02
32-4608-03	3	32-4700-03
32-4608-04	4	32-4700-04
	5	32-4700-05
	6	32-4700-06

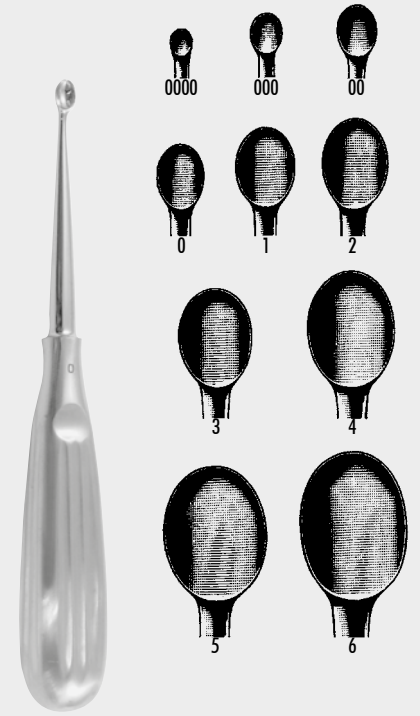

VOLKMANN 17,0 cm
32-4609-96 - 32-4700-06

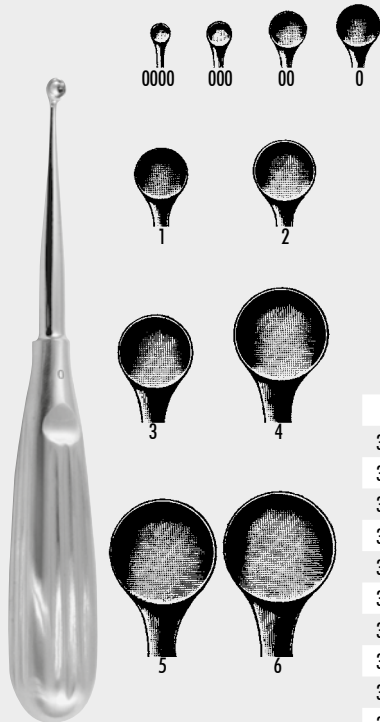

BRUNS 17,0 cm
32-4701-96 - 32-4702-06

BRUNS	Fig.	SPRATT
32-4701-96	0000	32-4704-96
32-4701-97	000	32-4704-97
32-4701-98	00	32-4704-98
32-4702-00	0	32-4705-00
32-4702-01	1	32-4705-01
32-4702-02	2	32-4705-02
32-4702-03	3	32-4705-03
32-4702-04	4	32-4705-04
32-4702-05	5	32-4705-05
32-4702-06	6	



SPRATT 17,0 cm
32-4704-97 - 32-4705-05



32-4607-97

32.36



Fig.	DAUBENSPECK 20,0 cm
0000	32-4719-96
000	32-4719-97
00	32-4719-98
0	32-4720-00



cm	« UFFENORDE »	
17,0	32-4723-17	32-4725-17

Scharfe Löffel
Bone Curettes
Cuillères tranchantes
Cucharillas cortantes
Curette taglienti

KNOCHENCHIRURGIE

BONE SURGERY

CHIRURGIE OSSEUSE

CIRUGÍA ÓSEA

CHIRURGIA OSSEA



mm	« KERPEL 14,5 cm »		
2,0	32-4731-02	32-4732-02	32-4733-02
3,0	32-4731-03	32-4732-03	32-4733-03

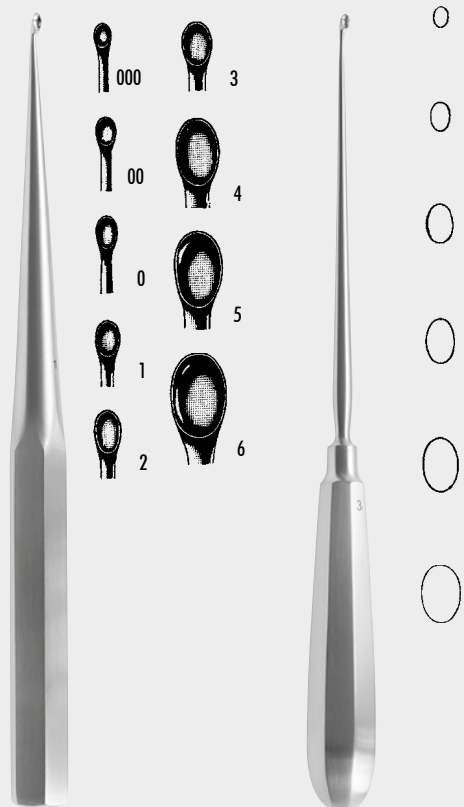

BRUNS 23,0 cm	Fig.	SIMON 24,0 cm
32-4800-97	000	
32-4800-98	00	
32-4801-00	0	
32-4801-01	1	32-4805-01
32-4801-02	2	32-4805-02
32-4801-03	3	32-4805-03
32-4801-04	4	32-4805-04
32-4801-05	5	32-4805-05
32-4801-06	6	32-4805-06



32-4805-06

32.37



Scharfe Löffel
 Bone Curettes
 Cuillères tranchantes
 Cucharillas cortantes
 Curette taglienti

KNOCHENCHIRURGIE

BONE SURGERY

CHIRURGIE OSSEUSE

CIRUGÍA ÓSEA

CHIRURGIA OSSEA



32-4816-96 - 32-4819-06

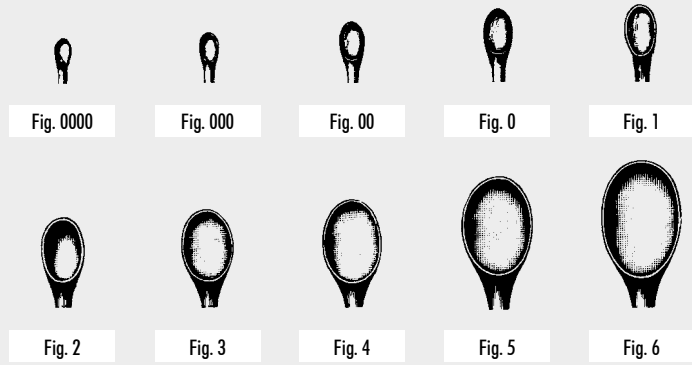

BRUNS (VOLKMANN) 23,0 cm		
	Fig.	
32-4816-96	0000	32-4818-96
32-4816-97	000	32-4818-97
32-4816-98	00	32-4818-98
32-4817-00	0	32-4819-00
32-4817-01	1	32-4819-01
32-4817-02	2	32-4819-02
32-4817-03	3	32-4819-03
32-4817-04	4	32-4819-04
32-4817-05	5	32-4819-05
32-4817-06	6	32-4819-06

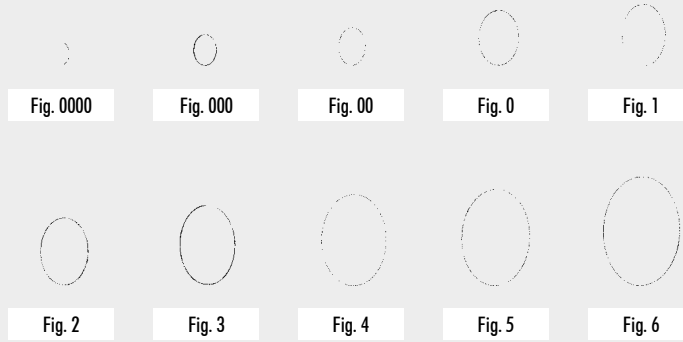

cm VOLKMANN
 17,0 32-4823-96 - 32-4824-06

VOLKMANN		
	Fig.	
32-4823-96	0000	
32-4823-97	000	
32-4823-98	00	
32-4824-00	0	32-4826-00
32-4824-01	1	32-4826-01
32-4824-02	2	32-4826-02
32-4824-03	3	32-4826-03
32-4824-04	4	32-4826-04
32-4824-05	5	
32-4824-06	6	



cm VOLKMANN
 27,0 32-4826-00 - 32-4826-04



32-4816-96

32.38





Fig.	mm	CASPAR 22,0 cm	
000	3,6	32-4828-36	
00	4,4	32-4828-44	
0	5,2	32-4828-52	



Fig.	mm	CASPAR 22,0 cm	
000	3,6	32-4829-36	
00	4,4	32-4829-44	
0	5,2	32-4829-52	

Scharfe Löffel
Bone Curettes
Cuillères tranchantes
Cucharillas cortantes
Curette taglienti

KNOCHENCHIRURGIE

BONE SURGERY

CHIRURGIE OSSEUSE

CIRUGÍA ÓSEA

CHIRURGIA OSSEA



mm	SEMMES 23,0 cm
4 x 7	32-4830-23



mm	SEMMES 23,0 cm
4 x 7	32-4831-23



mm	SEMMES 23,0 cm
4 x 7	32-4833-23

ZEPF[®]
α
INSTRUMENTS

32-4833-23

32.39

Scharfe Löffel
 Bone Curettes
 Cuillères tranchantes
 Cucharillas cortantes
 Curette taglienti

KNOCHENCHIRURGIE

BONE SURGERY

CHIRURGIE OSSEUSE

CIRUGÍA ÓSEA

CHIRURGIA OSSEA



Fig. 1



Fig. 2



Fig. 3



Fig.	EPSTEIN 20,0 cm
000	32-4848-97
00	32-4848-98
0	32-4849-00

Fig.	SCOVILLE 25,0 cm
1	32-4836-25
2	32-4837-25
3	32-4839-25



mm	CASPAR 25,0 cm
4,0	32-4852-04
5,0	32-4852-05



Fig.	LEMPERT 17,5 cm
0	32-4900-10
00	32-4900-20
000	32-4900-30
0000	32-4900-40
00000	32-4900-50



Fig.	HALLE 21,0 cm
1	32-4901-01
2	32-4901-02
3	32-4901-03

ZEPF[®]
α
 INSTRUMENTS

32-4836-25

32.40



32-5001-00
Fig. 000



32-5002-00
Fig. 00



32-5003-00
Fig. 0



32-5003-01
Fig. 1



32-5003-02
Fig. 2



32-5003-03
Fig. 3



32-5003-04
Fig. 4



32-5003-05
Fig. 5



32-5003-06
Fig. 6



cm COBB
28,0 32-5001-00 - 32-5003-07



32-5005-97
32-5007-97



32-5005-98
32-5007-98



32-5006-00
32-5008-00



32-5006-01
32-5008-01



32-5006-02
32-5008-02



32-5006-03
32-5008-03



32-5006-04
32-5008-04



32-5006-05
32-5008-05



32-5006-06
32-5008-06



cm HATFIELD
23,0 32-5005-97 - 32-5006-06



cm HATFIELD
28,0 32-5007-97 - 32-5008-06

Spinal-Löffel
Spinal Fusion Curettes
Curettes tranchantes pour la fusion spinale
Curetas cortantes para la fusión espinal
Curette taglienti per la fusione spinale

KNOCHENCHIRURGIE

BONE SURGERY

CHIRURGIE OSSEUSE

CIRUGÍA ÓSEA

CHIRURGIA OSSEA



32-5008-06

32.41



Spinal-Löffel
 Spinal Fusion Curettes
 Curettes tranchantes pour la fusion spinale
 Curetas cortantes para la fusión espinal
 Curette taglianti per la fusione spinale

KNOCHENCHIRURGIE

BONE SURGERY

CHIRURGIE OSSEUSE

CIRUGÍA ÓSEA

CHIRURGIA OSSEA

Scharfe Löffel
 Bone Curettes
 Cuillères tranchantes
 Cucharillas cortantes
 Curette taglianti



32-5100-36
 32-5101-36



32-5100-44
 32-5101-44



32-5100-52
 32-5101-52



32-5100-60
 32-5101-60



cm 25,0 32-5101-36 - 32-5101-60



mm BUSHE 25,0 cm
 3,0 32-5103-03
 4,0 32-5103-04
 5,0 32-5103-05



cm VOLKMANN
 22,0 32-5120-01 - 32-5120-03



32-5120-01
 Fig. 1



32-5120-02
 Fig. 2



32-5120-03
 Fig. 3



cm JANSEN
 15,0 32-5130-15



mm STANLEY BOYD
 13,0 32-5140-13
 16,0 32-5140-16
 20,0 32-5140-20



32-5100-36

32.42



cm	VOLKMANN
13,0	32-5302-13
14,0	32-5302-14
17,0	32-5302-17



cm	VOLKMANN
13,0	32-5304-13
14,0	32-5304-14
17,0	32-5304-17
20,0	32-5304-20

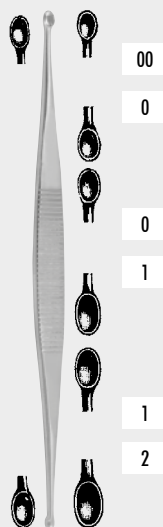

Fig.	WILLIGER 13,5 cm
00/0	32-5306-00
0/1	32-5306-01
1/2	32-5306-12

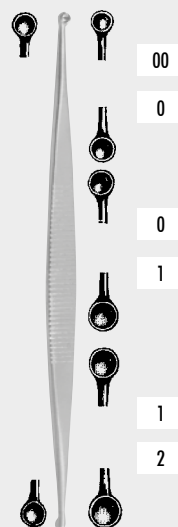

Fig.	MARTINI 13,5 cm
00/0	32-5308-00
0/1	32-5308-01
1/2	32-5308-12

Scharfe Löffel
Bone Curettes
Cuillères tranchantes
Cucharillas cortantes
Curette taglianti

KNOCHENCHIRURGIE

BONE SURGERY

CHIRURGIE OSSEUSE

CIRUGÍA ÓSEA

CHIRURGIA OSSEA



cm	
21,0	32-5310-21



cm	JACOBSON
14,0	32-5312-14



cm	BARTH
18,0	32-5314-18



32-5314-18

32.43

Meissel
Chisels and Gouges
Ciseaux-burins et gouges
Cinceles y gubias
Scalpelli e sgorbie

KNOCHENCHIRURGIE

BONE SURGERY

CHIRURGIE OSSEUSE

CIRUGÍA ÓSEA

CHIRURGIA OSSEA



mm KRÄMER 17,0 cm
2,5 32-5401-25



32-5800-00

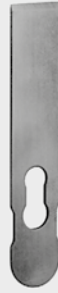

mm	
5 / 45	32-5800-05
10 / 45	32-5800-10
16 / 45	32-5800-16
25 / 45	32-5800-25



mm	
25 / 78	32-5800-78

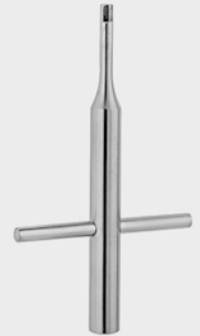

32-5800-99



mm	MANNERFELDT 16,0 cm
3,0	32-5998-03



mm	MANNERFELDT 16,0 cm
4,0	32-6000-04
6,0	32-6000-06
8,0	32-6000-08



mm	13,5 cm
2,0	32-6002-02
4,0	32-6002-04
6,0	32-6002-06
8,0	32-6002-08
10,0	32-6002-10
12,0	32-6002-12
14,0	32-6002-14
16,0	32-6002-16



mm	13,5 cm
4,0	32-6004-04
6,0	32-6004-06
8,0	32-6004-08
10,0	32-6004-10
12,0	32-6004-12
14,0	32-6004-14
16,0	32-6004-16



mm	13,5 cm
4,0	32-6005-04
6,0	32-6005-06
8,0	32-6005-08
10,0	32-6005-10
12,0	32-6005-12
14,0	32-6005-14
16,0	32-6005-16

Meissel
Chisels and Gouges
Ciseaux-burins et gouges
Cinceles y gubias
Scalpelli e sgorbie

KNOCHENCHIRURGIE

BONE SURGERY

CHIRURGIE OSSEUSE

CIRUGÍA ÓSEA

CHIRURGIA OSSEA



mm	EAST GRINSTEAD (WARD) 18,0 cm
3,0	32-6010-03
5,0	32-6010-05



mm	EAST GRINSTEAD (WARD) 18,0 cm
3,0	32-6012-03
5,0	32-6012-05



mm	EASTMAN 19,0 cm
3,0	32-6020-03
5,0	32-6020-05



32-6020-05

32.45



Meissel
Chisels and Gouges
Ciseaux-burins et gouges
Cincales y gubias
Scalpelli e sgorbie

KNOCHENCHIRURGIE

BONE SURGERY

CHIRURGIE OSSEUSE

CIRUGÍA ÓSEA

CHIRURGIA OSSEA

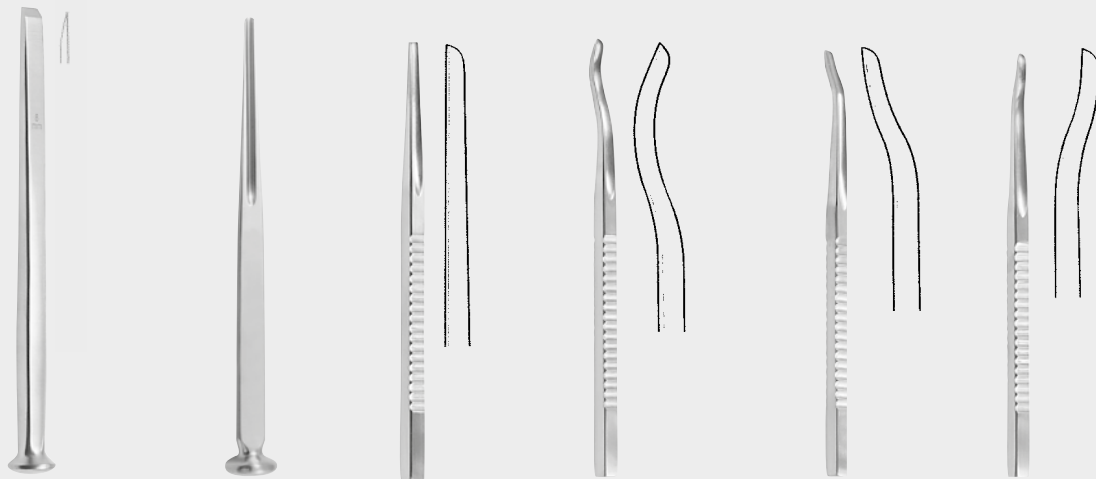

mm	ALEXANDER 17,0 cm	mm	ALEXANDER 17,0 cm	Fig.	BUCK GRAMCKO	Fig.	BUCK GRAMCKO	Fig.	BUCK GRAMCKO	Fig.	BUCK GRAMCKO
4,0	32-6100-04	4,0	32-6101-04	1	32-6110-01	2	32-6111-02	3	32-6111-03	4	32-6111-04
6,0	32-6100-06	6,0	32-6101-06		13,5 cm		13,5 cm		13,5 cm		13,5 cm
8,0	32-6100-08	8,0	32-6101-08		3,4 mm		3,4 mm		3,4 mm		3,4 mm
10,0	32-6100-10	10,0	32-6101-10								
12,0	32-6100-12	12,0	32-6101-12								
14,0	32-6100-14	14,0	32-6101-14								



mm	GILLIES (FRENCH) (CARROLL) 14,0 cm	mm	PARTSCH 13,5 cm	PARTSCH 17,5 cm	mm	PARTSCH 13,5 cm	PARTSCH 17,5 cm
5,0	32-6114-05	2,0	32-6200-02	32-6202-02	2,0	32-6203-02	32-6205-02
7,0	32-6114-07	3,0	32-6200-03	32-6202-03	3,0	32-6203-03	32-6205-03
9,0	32-6114-09	4,0	32-6200-04	32-6202-04	4,0	32-6203-04	32-6205-04
11,0	32-6114-11	5,0	32-6200-05	32-6202-05	5,0	32-6203-05	32-6205-05
		6,0	32-6200-06	32-6202-06	6,0	32-6203-06	32-6205-06
		7,0	32-6200-07	32-6202-07	7,0	32-6203-07	32-6205-07
		8,0	32-6200-08	32-6202-08	8,0	32-6203-08	32-6205-08
		10,0	32-6200-10	32-6202-10	10,0	32-6203-10	
		12,0	32-6200-12	32-6202-12			



32-6100-04

32.46

Meissel
Chisels and Gouges
Ciseaux-burins et gouges
Cinceles y gubias
Scalpelli e sgorbie



mm	STILLE 20,0 cm
6,0	32-6300-06
8,0	32-6300-08
10,0	32-6300-10
12,0	32-6300-12
15,0	32-6300-15
20,0	32-6300-20
25,0	32-6300-25
30,0	32-6300-30



mm	STILLE 20,0 cm	STILLE 20,0 cm
6,0	32-6302-06	32-6303-06
8,0	32-6302-08	32-6303-08
10,0	32-6302-10	32-6303-10
12,0	32-6302-12	32-6303-12
15,0	32-6302-15	32-6303-15
20,0	32-6302-20	32-6303-20
25,0	32-6302-25	32-6303-25
30,0	32-6302-30	



mm	STILLE 20,0 cm
6,0	32-6305-06
8,0	32-6305-08
10,0	32-6305-10
12,0	32-6305-12
15,0	32-6305-15
20,0	32-6305-20
25,0	32-6305-25
30,0	32-6305-30

KNOCHENCHIRURGIE

BONE SURGERY

CHIRURGIE OSSEUSE

CIRUGÍA ÓSEA

CHIRURGIA OSSEA



mm	SMITH-PETERSEN 20,0 cm
6,0	32-6404-06
9,0	32-6404-09
13,0	32-6404-13
16,0	32-6404-16
19,0	32-6404-19
25,0	32-6404-25
32,0	32-6404-32



mm	SMITH-PETERSEN 20,0 cm
6,0	32-6405-06
9,0	32-6405-09
13,0	32-6405-13
16,0	32-6405-16
19,0	32-6405-19
25,0	32-6405-25
32,0	32-6405-32



mm	SMITH-PETERSEN 20,0 cm
6,0	32-6407-06
9,0	32-6407-09
13,0	32-6407-13
16,0	32-6407-16
19,0	32-6407-19
25,0	32-6407-25
32,0	32-6407-32



mm	SMITH-PETERSEN 20,0 cm
6,0	32-6409-06
9,0	32-6409-09
13,0	32-6409-13
16,0	32-6409-16
19,0	32-6409-19
25,0	32-6409-25
32,0	32-6409-32



32-6409-32

32.47



Meissel
Chisels and Gouges
Ciseaux-burins et gouges
Cinceles y gubias
Scalpelli e sgorbie

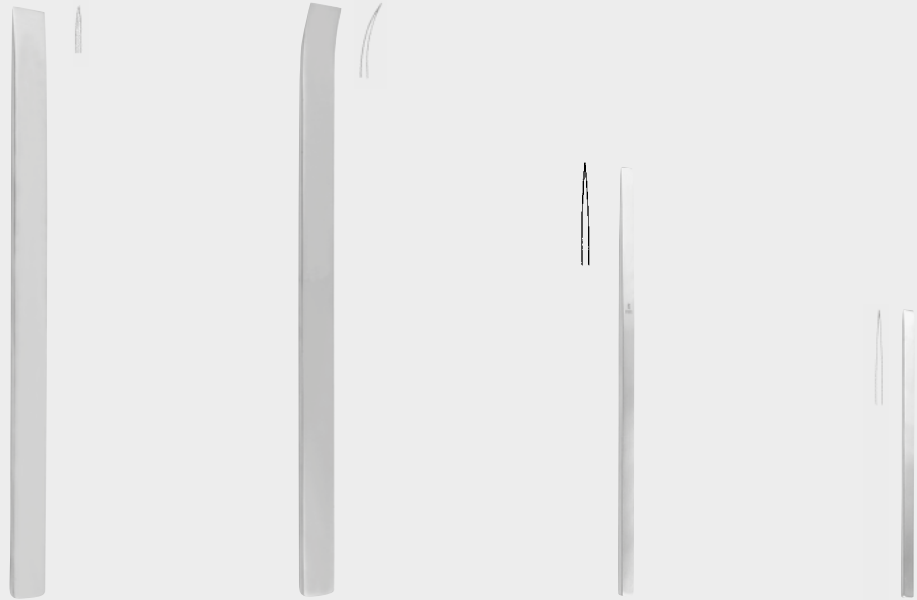

KNOCHENCHIRURGIE

BONE SURGERY

CHIRURGIE OSSEUSE

CIRUGÍA ÓSEA

CHIRURGIA OSSEA

mm	LAMBOTTE 25,0 cm	mm	LAMBOTTE 25,0 cm	mm	LAMBOTTE mini 17,0 cm	mm	LAMBOTTE mini 12,5 cm
4,0	32-6500-04	4,0	32-6501-04	2,0	32-6502-02	2,0	32-6504-02
6,5	32-6500-06	6,5	32-6501-06	3,0	32-6502-03	3,0	32-6504-03
8,0	32-6500-08	8,0	32-6501-08	4,0	32-6502-04	4,0	32-6504-04
10,0	32-6500-10	10,0	32-6501-10	6,0	32-6502-06	6,0	32-6504-06
13,0	32-6500-13	13,0	32-6501-13	8,0	32-6502-08	8,0	32-6504-08
15,0	32-6500-15	15,0	32-6501-15	10,0	32-6502-10	10,0	32-6504-10
18,0	32-6500-18	18,0	32-6501-18	12,0	32-6502-12	12,0	32-6504-12
20,0	32-6500-20	20,0	32-6501-20	15,0	32-6502-15	15,0	32-6504-15
25,0	32-6500-25	25,0	32-6501-25				
30,0	32-6500-30	30,0	32-6501-30				
38,0	32-6500-38	38,0	32-6501-38				
44,0	32-6500-44	44,0	32-6501-44				
50,0	32-6500-50	50,0	32-6501-50				

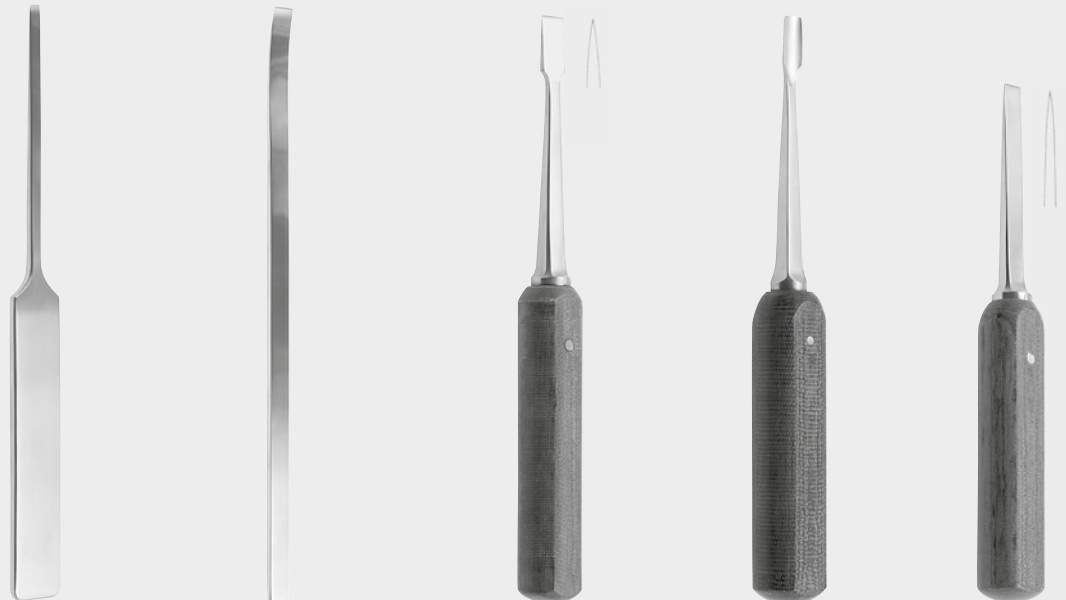

mm	LAMBOTTE 25,0 cm	mm	NIEDERDELMANN 25,0 cm	mm	LEXER 22,0 cm	mm	LEXER 22,0 cm	mm	LEXER mini 18,0 cm
4,0	32-6510-04	8,0	32-6521-08	5,0	32-6600-05	5,0	32-6601-05	4,0	32-6604-04
6,0	32-6510-06	10,0	32-6521-10	7,0	32-6600-07	7,0	32-6601-07	6,0	32-6604-06
8,0	32-6510-08			10,0	32-6600-10	10,0	32-6601-10	8,0	32-6604-08
10,0	32-6510-10			15,0	32-6600-15	15,0	32-6601-15	10,0	32-6604-10
				20,0	32-6600-20	20,0	32-6601-20	12,0	32-6604-12
				25,0	32-6600-25	25,0	32-6601-25		
				30,0	32-6600-30	30,0	32-6601-30		



32-6500-04

32.48

Meissel
Chisels and Gouges
Ciseaux-burins et gouges
Cinceles y gubias
Scalpelli e sgorbie



mm LEXER mini 18,0 cm		mm LEXER 28,0 cm		mm LEXER 28,0 cm		mm LEXER Spongiosa 25,0 cm		mm LEXER Spongiosa 25,0 cm	
4,0	32-6605-04	10,0	32-6607-10	10,0	32-6609-10	5,0	32-6610-05	5,0	32-6611-05
6,0	32-6605-06	15,0	32-6607-15	15,0	32-6609-15	10,0	32-6610-10	10,0	32-6611-10
8,0	32-6605-08					15,0	32-6610-15	15,0	32-6611-15
10,0	32-6605-10								
12,0	32-6605-12								

KNOCHENCHIRURGIE

BONE SURGERY

CHIRURGIE OSSEUSE

CIRUGÍA ÓSEA

CHIRURGIA OSSEA

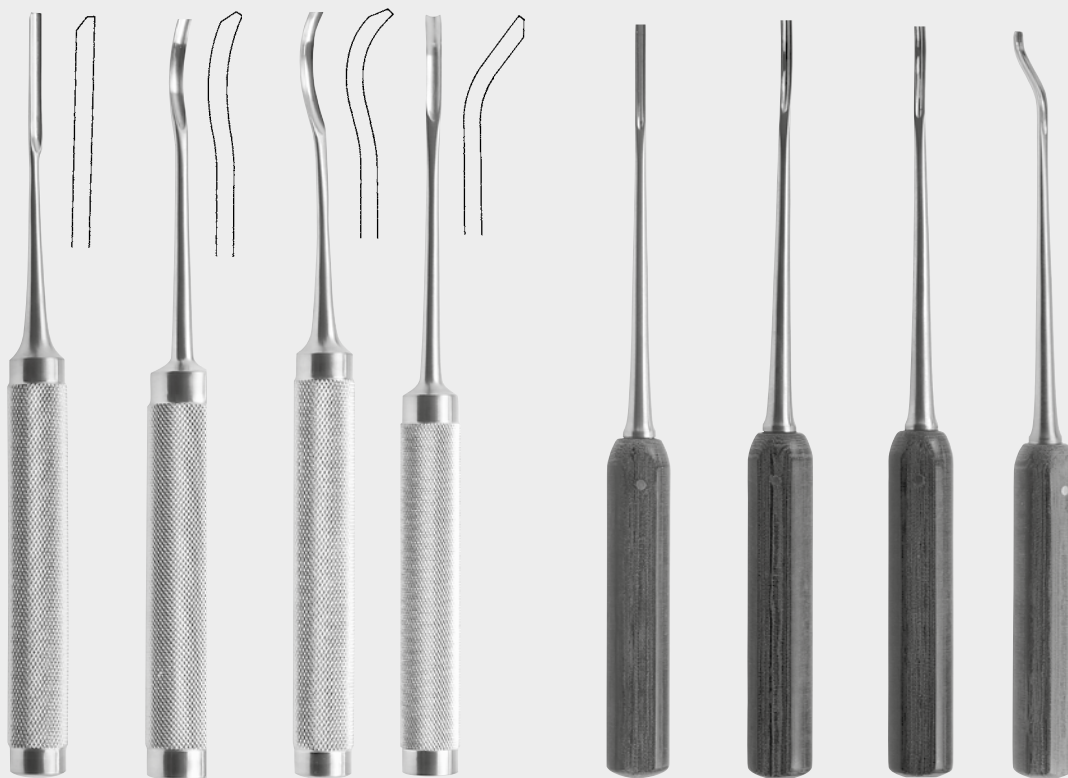

COBB Spinal 28,0 cm 6,0 mm
32-6620-01 32-6621-02 32-6621-03 32-6621-04

COBB Spinal 28,0 cm
32-6622-01 32-6623-02 32-6623-03 32-6623-04



32-6623-04

32.49

Meissel
Chisels and Gouges
Ciseaux-burins et gouges
Cinceles y gubias
Scalpelli e sgorbie

KNOCHENCHIRURGIE

BONE SURGERY

CHIRURGIE OSSEUSE

CIRUGÍA ÓSEA

CHIRURGIA OSSEA



mm	ZIELKE 23,0 cm	
5,5	32-6631-05	
9,0	32-6631-09	



mm	23,0 cm
9,0	32-6689-09



mm	HOKE 17,0 cm
3,0	32-6698-03
5,0	32-6698-05
6,0	32-6698-06
8,0	32-6698-08
9,0	32-6698-09



mm	HIBBS 24,0 cm		mm	HIBBS 24,0 cm		mm	HIBBS 24,0 cm		mm	HIBBS 24,0 cm		mm	HIBBS 24,0 cm	
6,0	32-6700-06		6,0	32-6701-06		6,0	32-6702-06		6,0	32-6703-06		6,0	32-6705-06	
13,0	32-6700-13		13,0	32-6701-13		13,0	32-6702-13		13,0	32-6703-13		13,0	32-6705-13	
19,0	32-6700-19		19,0	32-6701-19		19,0	32-6702-19		19,0	32-6703-19		19,0	32-6705-19	
25,0	32-6700-25		25,0	32-6701-25		25,0	32-6702-25		25,0	32-6703-25		25,0	32-6705-25	
32,0	32-6700-32		32,0	32-6701-32		32,0	32-6702-32		32,0	32-6703-32		32,0	32-6705-32	



32-6631-05

32.50



mm	20,0 cm	20,0 cm
10,0	32-6710-10	32-6711-10
15,0	32-6710-15	32-6711-15
20,0	32-6710-20	32-6711-20



cm	mm	mm
24,0	20,0	32-6712-20
26,0	16,0	32-6714-16



ø mm	15,5 cm
2,0	32-6752-02
3,0	32-6752-03
4,0	32-6752-04
5,0	32-6752-05
6,0	32-6752-06
8,0	32-6752-08
10,0	32-6752-10



ø mm	CASPAR 20,0 cm
3,0	32-6760-03
5,0	32-6760-05
8,0	32-6760-08

Meissel
Chisels and Gouges
Ciseaux-burins et gouges
Cinceles y gubias
Scalpelli e sgorbie

KNOCHENCHIRURGIE

BONE SURGERY

CHIRURGIE OSSEUSE

CIRUGÍA ÓSEA

CHIRURGIA OSSEA



ø mm	20,0 cm
12,0	32-6762-12
14,0	32-6762-14
16,0	32-6762-16



ø mm	21,0 cm
6 x 8	32-6764-01
10 x 12	32-6764-02



mm	18,0 cm
6 x 13	32-6766-13
10 x 15	32-6766-15
11 x 20	32-6766-20



ø mm	17,0 cm
10 x 16	32-6768-10



mm	DEMOISELLE 18,0 cm
8 x 5	32-6770-05
12 x 8	32-6770-08
20 x 12	32-6770-12

Siößel
Tamper
Pylone
Pisón
Battitori



32-6770-12

32.51

Meissel
Chisels and Gouges
Ciseaux-burins et gouges
Cincoles y gubias
Scalpelli e sgorbie

KNOCHENCHIRURGIE

BONE SURGERY

CHIRURGIE OSSEUSE

CIRUGÍA ÓSEA

CHIRURGIA OSSEA



mm HAASE 10,0 cm
5,7 32-6772-10



cm LEBSCHKE
24,5 32-6788-24



cm
22,0 32-6791-22



cm VIRCHOW
12,0 32-6794-12



« BRUNETTI 28,0 cm »
32-6801-28 32-6803-28

ZEPF[®]
α
INSTRUMENTS

32-6772-10

32.52



32-6804-00



32-6805-01



32-6805-04



cm
14,0 32-6805-90



cm mm
13,0 32-6805-99 23

Autopsie-Besteck, Präparier-Bestecke
Post Mortem Set, Dissecting Kits
Set à autopsie, Sets à dissection
Juego de autopsia, Sets de disección
Set per autopsia, Set per dissezione

KNOCHENCHIRURGIE

BONE SURGERY

CHIRURGIE OSSEUSE

CIRUGÍA ÓSEA

CHIRURGIA OSSEA

Schädelspalter, Osteotom
Skull Breaker, Osteotome
Casse-crâne, ostéotome
Rompecráneo, osteótomo
Spacca cranio, osteotomo

ZEPF[®]
α
INSTRUMENTS

32-6805-99

32.53



Hämmer
Hammers and Mallets
Maillets et Masses
Martillos y mazos
Martelli

KNOCHENCHIRURGIE

BONE SURGERY

CHIRURGIE OSSEUSE

CIRUGÍA ÓSEA

CHIRURGIA OSSEA



g	GERZOG	g	KIRK	g	COTTLE	ø mm	g	OMBREDANNE	ø mm	g	ø mm	
250	32-6806-25	750	32-6808-75	240	32-6809-24	30,0	550	32-6812-55	40,0	480	32-6820-48	30,0
	18,0 cm		19,0 cm		19,0 cm			24,0 cm			24,0 cm	



32-6822-00	24,0 cm	g	510	32-6824-51	26,5 cm	g	510	32-6826-00	26,0 cm	g	450	32-6900-45	900	32-6900-90	26,5 cm	g	220	32-6902-22	30,0	20,0 cm



32-6806-25

32.54



g		ø mm
300	32-6903-30	30,0
500	32-6903-50	35,0
700	32-6903-70	40,0

g	WILLIGER	ø mm
300	32-6904-30	26,0
340	32-6904-34	28,0
400	32-6904-40	30,0

g	BERGMANN	ø mm
300	32-6905-30	30,0

g	BERGMANN	ø mm
300	32-6905-45	45,0

Hämmer
Hammers and Mallets
Maillets et Masses
Martillos y mazos
Martelli

KNOCHENCHIRURGIE

BONE SURGERY

CHIRURGIE OSSEUSE

CIRUGÍA ÓSEA

CHIRURGIA OSSEA



g	LUCAE	
230	32-6906-23	
260	32-6906-26	19,0 cm

g	DOYEN	ø mm
120	32-6910-12	25,0
180	32-6910-18	30,0
260	32-6910-26	35,0
		21,0 cm

g		ø mm
140	32-6912-14	20,0
		16,5 cm

g	PARTSCH	ø mm
200	32-6914-20	22,0
		18,0 cm

g	HAJEK	ø mm
140	32-6916-20	27,0
		22,0 cm



32-6916-20

32.55



Hämmer
Hammers and Mallets
Maillets et Masses
Martillos y mazos
Martelli

KNOCHENCHIRURGIE

BONE SURGERY

CHIRURGIE OSSEUSE

CIRUGÍA ÓSEA

CHIRURGIA OSSEA



WAGNER compl.	ø mm
32-6968-00	35,0
23,5 cm	



g	Metall / metal	ø mm
230	32-6968-23	35



g	Plastic	ø mm
32	32-6968-32	35



32-6968-99



32-6970-99

g	ø mm
370	32-6970-37
22,5 cm	

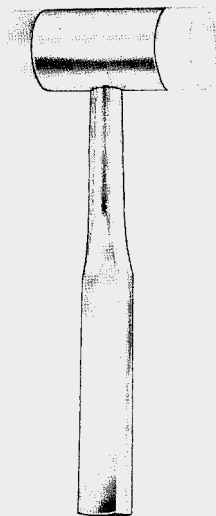

g	ø mm
140	32-6974-14
18,5 cm	



32-6974-99



32-6976-99

g	MEAD
200	32-6976-32
17,0 cm	



g	
250	32-6978-25
400	32-6978-40
26,0 cm	



32-6968-00

32.56

Hämmer und Schlägel
Hammers and Mallets
Maillets et Masses
Martillos y mazos
Martelli

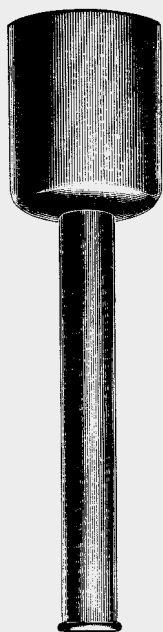

g	STEINBACH	ø mm
400	32-6980-40	80x60
24,0 cm		



g	ø mm
400	32-6982-40
26,0 cm	



g	ø mm
125	32-6984-13
18,0 cm	

KNOCHENCHIRURGIE

BONE SURGERY

CHIRURGIE OSSEUSE

CIRUGÍA ÓSEA

CHIRURGIA OSSEA

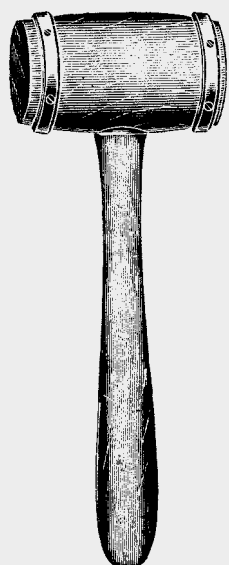

g	ø mm
290	32-6986-29
23,0 cm	

ø mm
42,0



ø mm
30,0

g	ø mm
530	32-6988-53
26,5 cm	



g	HEATH	ø mm
700	32-6990-70	40,0
18,5 cm		



32-6990-70

32.57



Hämmer
Hammers and Mallets
Maillets et Masses
Martillos y mazos
Martelli

KNOCHENCHIRURGIE

BONE SURGERY

CHIRURGIE OSSEUSE

CIRUGÍA ÓSEA

CHIRURGIA OSSEA



g	JUDET
800	32-6992-08
1000	32-6992-10
1200	32-6992-12



g	HEATH ø 45,0 mm
1000	32-6994-10



g / mm	Mc EVEN
250 / 25	32-6996-25
350 / 30	32-6996-35
500 / 35	32-6996-50
750 / 40	32-6996-75
	22,0 cm



g / mm	Mc EVEN
250 / 25	32-6997-25
350 / 30	32-6997-35
500 / 35	32-6997-50
600 / 40	32-6997-60
750 / 45	32-6997-75
	22,0 cm



QUISLING
32-6998-75



für Autopsie
Post-mortem
pour autopsie
para autopsia
per autopsia

cm
23,5 32-6999-00



32-6992-08

32.58



cm FARABEUFF —
15,0 32-7002-15



cm FARABEUFF —
15,0 32-7003-15



cm FARABEUFF COLLIN —
16,0 32-7004-16



cm FARABEUFF COLLIN —
16,0 32-7005-16

Raspatorien
Raspatories, Periosteal Elevators
Rugines-raspatoires
Legras
Periostotomi

KNOCHENCHIRURGIE

BONE SURGERY

CHIRURGIE OSSEUSE

CIRUGÍA ÓSEA

CHIRURGIA OSSEA



mm LAMBOTTE 21,0 cm —
5,0 32-7007-05
10,0 32-7007-10
15,0 32-7007-15
20,0 32-7007-20
25,0 32-7007-25

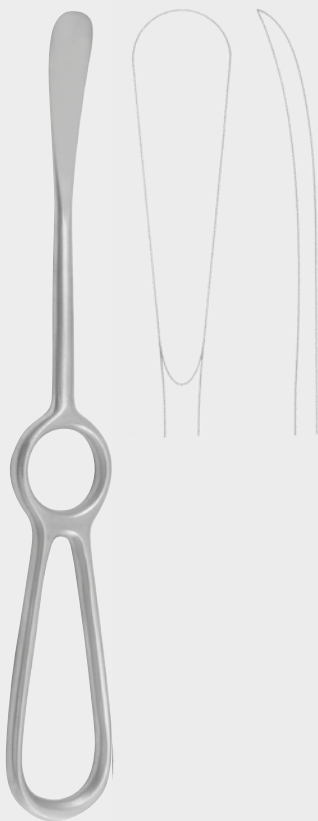

cm SEDILLOT —
21,0 32-7009-21



cm SEDILLOT —
18,5 32-7011-18



32-7011-18

32.59

Raspatorien
 Raspatories, Periosteal Elevators
 Rugines-raspatoires
 Periotótomos
 Periostotomi

KNOCHENCHIRURGIE

BONE SURGERY

CHIRURGIE OSSEUSE

CIRUGÍA ÓSEA

CHIRURGIA OSSEA



cm BRISTOW
 18,0 32-7013-18



DEWARE (COBB) 20,0 cm
 32-7021-20



mm MATTHIEU 17,0 cm
 6,0 32-7100-06
 9,0 32-7100-09



cm LANGENBECK
 19,0 32-7102-19



cm LANGENBECK
 18,0 32-7103-18

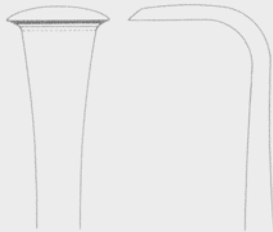

cm JANSEN
 16,5 32-7105-16



cm SCHNEIDER
 17,5 32-7107-17



cm SCHNEIDER SAUERBRUCH
19,0 32-7109-19



cm CUSHING Little Joker
15,0 32-7111-15



cm CUSHING Little Joker
19,0 32-7113-19

Raspatorien
Raspatories, Periosteal Elevators
Rugines-raspatoirs
Legras
Periostotomi

KNOCHENCHIRURGIE

BONE SURGERY

CHIRURGIE OSSEUSE

CIRUGÍA ÓSEA

CHIRURGIA OSSEA



Fig.	mm	WIBERG 17,0 cm
1	4,0	32-7118-04
2	7,0	32-7118-07
3	9,0	32-7118-09
4	12,0	32-7118-12



mm KÖNIG 15,5 cm
15 32-7177-15



cm
17,0 32-7179-06 - 32-7179-08

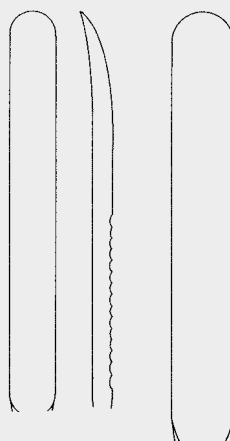

mm	mm
6,0	8,0
32-7179-06	32-7179-08

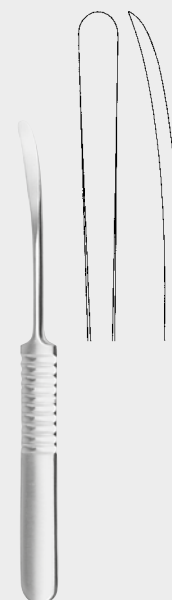

cm WILLIGER
13,0 32-7181-13



32-7181-13

32.61



Raspatorien
 Raspatories, Periosteal Elevators
 Rugines-raspatoires
 Periotótomos
 Periototomi

KNOCHENCHIRURGIE

BONE SURGERY

CHIRURGIE OSSEUSE

CIRUGÍA ÓSEA

CHIRURGIA OSSEA



mm	16,0 cm
5,0	32-7182-05
6,0	32-7182-06
7,0	32-7182-07



cm	WILLIGER	mm
16,0	32-7183-16	6,0
16,0	32-7183-17	7,0



mm	WILLINGER KAHRE 16,5 cm
4,0	32-7184-04
5,0	32-7184-05

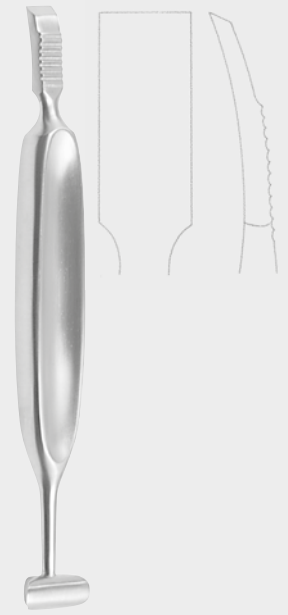

cm	ALEXANDER
16,0	32-7185-16
20,0	32-7185-20



cm	»	DOYEN	«
17,0	32-7201-17		32-7203-17
24,0	32-7201-24		32-7203-24
17,0	32-7205-17		32-7207-17



»
32-7201-17
32-7201-24



«
32-7203-17
32-7203-24



»
32-7205-17



«
32-7207-17



32-7182-05

32.62



cm	cm	cm	cm	cm	cm	cm	cm
17,5	21,0	17,5	21,0	20,5	20,5	20,5	20,5
32-7209-01	32-7209-02	32-7209-03	32-7209-04	32-7209-05	32-7209-06	32-7209-07	



SEMB
32-7209-01 - 32-7209-07

Raspatorien
Raspatories, Periosteal Elevators
Rugines-raspatoires
Legras
Periostotomi

KNOCHENCHIRURGIE

BONE SURGERY

CHIRURGIE OSSEUSE

CIRUGÍA ÓSEA

CHIRURGIA OSSEA



MATSON-ALEXANDER
32-7301-22



cm **MATSON**
22,0 32-7303-22

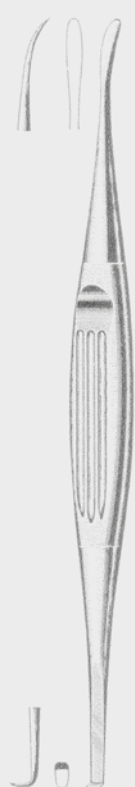

cm **OVERHOLT**
29,5 32-7305-29

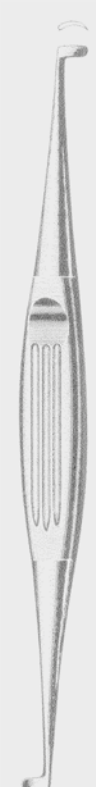

cm **OVERHOLT**
29,5 32-7307-29

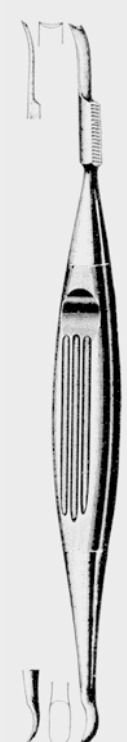

cm **OVERHOLT**
29,5 32-7309-28



32-7309-28

32.63

Raspatorien
 Raspatories, Periosteal Elevators
 Rugines-raspatoires
 Periotótomos
 Periostotomi

KNOCHENCHIRURGIE

BONE SURGERY

CHIRURGIE OSSEUSE

CIRUGÍA ÓSEA

CHIRURGIA OSSEA



mm LANDOLT 17,5 cm
 4,7 32-7400-47



mm CASPAR 18,0 cm
 6,2 32-7401-62



mm CASPAR 18,0 cm
 6,2 32-7402-62



mm CASPAR 17,0 cm
 3,0 32-7403-03
 6,0 32-7403-06



cm CASPAR
 20,5 32-7404-01



cm CASPAR
 20,5 32-7404-02



cm SEBILEAU
 17,5 32-7451-17
 5,0 mm



cm QUERVAIN
 19,5 32-7453-19
 6,0 mm

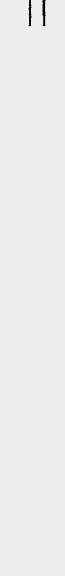

cm KÖNIG
 15,5 32-7457-15
 4,5 mm

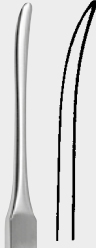

cm KÖNIG
 15,5 32-7459-15
 4,5 mm



32-7400-47

32.64

Elevatorii
Elevators
Elévateurs
Elevadores
Elevatori

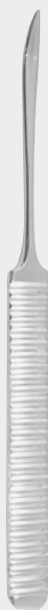

cm	WILLIGER
16,5	32-7461-16
	5,0 mm

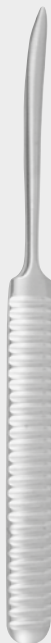

cm	WILLIGER
17,0	32-7461-17
	5,5 mm



cm	MARTIN LANGENBECK	mm
17,0	32-7490-05	5,0
17,0	32-7490-07	7,0
19,5	32-7490-08	8,0
19,5	32-7490-10	10,0



SAYRE 17,0 cm
32-7494-01
32-7494-02
9,0 mm



cm	CAIRNS
18,0	32-7495-18

KNOCHENCHIRURGIE

BONE SURGERY

CHIRURGIE OSSEUSE

CIRUGÍA ÓSEA

CHIRURGIA OSSEA



cm	OHL
18,0	32-7496-18



cm	LANGENBECK	mm
20,0	32-7501-08	8,0
20,0	32-7501-10	10,0



cm	JONES
18,5	32-7503-18



cm	ADSON
17,0	32-7504-17 - 32-7507-17



32-7504-17



32-7505-17



32-7506-17



32-7507-17



32-7507-17

32.65



Raspatorien
 Raspatories, Periosteal Elevators
 Rugines-raspatoires
 Periotótomos
 Periostotomi

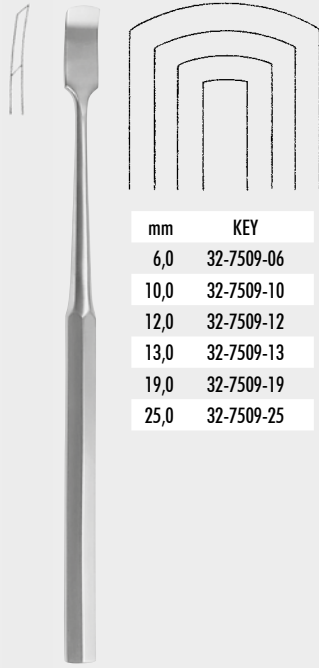

mm	KEY
6,0	32-7509-06
10,0	32-7509-10
12,0	32-7509-12
13,0	32-7509-13
19,0	32-7509-19
25,0	32-7509-25



mm CUSHING 19,5 cm
5,0 32-7602-19



mm CUSHING 18,0 cm
16,0 32-7603-18



mm CUSHING 18,0 cm
16,0 32-7604-18

KNOCHENCHIRURGIE

BONE SURGERY

CHIRURGIE OSSEUSE

CIRUGÍA ÓSEA

CHIRURGIA OSSEA



cm WATSON CHEYNE
17,5 32-7605-17



cm McDONALD
19,0 32-7607-19



cm
17,5 32-7609-17

sehr leicht
 light weight
 très léger
 muy ligero
 molto leggero



cm HOWARTH
21,5 32-7611-21



cm SYME
18,5 32-7613-18



32-7509-06

32.66



mm MÜHLING 17,0 cm
4,0 32-7615-01



mm MÜHLING 17,0 cm
4,0 32-7615-02



mm MÜHLING 17,0 cm
4,0 32-7615-03



mm MÜHLING 17,0 cm
4,0 32-7615-04

Raspatorien
Raspatories, Periosteal Elevators
Rugines-raspatoires
Legras
Periostotomi

KNOCHENCHIRURGIE

BONE SURGERY

CHIRURGIE OSSEUSE

CIRUGÍA ÓSEA

CHIRURGIA OSSEA



cm mm
19,0 32-7621-01 6,0



cm mm
18,5 32-7621-02 3,0



cm mm
19,0 32-7621-03 6,0



cm mm
19,0 32-7621-04 6,0



32-7621-04

32.67

Raspatorien
 Raspatories, Periosteal Elevators
 Rugines-raspatoires
 Periotótomos
 Periostotomi

KNOCHENCHIRURGIE

BONE SURGERY

CHIRURGIE OSSEUSE

CIRUGÍA ÓSEA

CHIRURGIA OSSEA



cm		mm
18,5	32-7623-01	13,0



cm		mm
19,5	32-7623-02	14,0

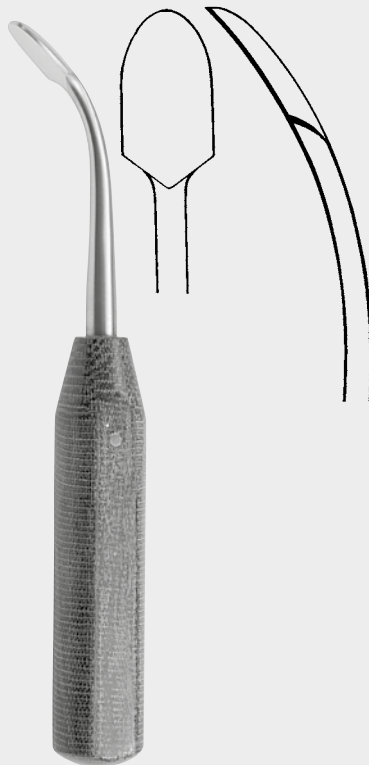

cm		mm
19,0	32-7623-03	14,0

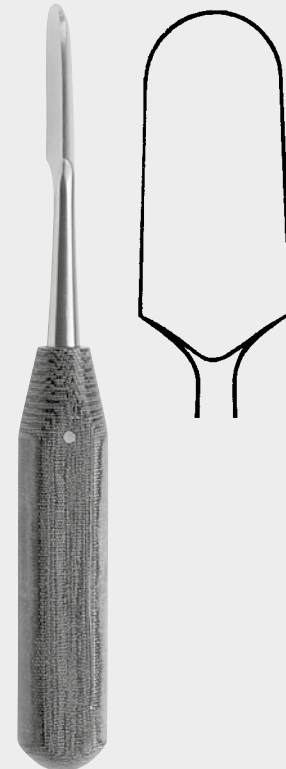

cm		mm
20,0	32-7623-04	20,0

ZEPF[®]

 INSTRUMENTS

32-7623-01

32.68

Raspatorien
 Raspatories, Periosteal Elevators
 Rugines-raspatoires
 Periotómos
 Periostotomi

KNOCHENCHIRURGIE

BONE SURGERY

CHIRURGIE OSSEUSE

CIRUGÍA ÓSEA

CHIRURGIA OSSEA



mm	COBB
10,0	32-7631-10
13,0	32-7631-13
19,0	32-7631-19
28,0 cm	



HOEN (GUTSCH)
 32-7633-07 - 32-7637-20



cm	mm
16,0	32-7633-07 7,0

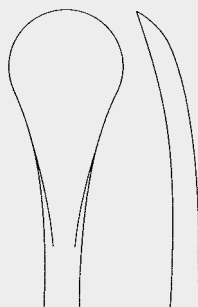

cm	mm
18,5	32-7635-15 15,0

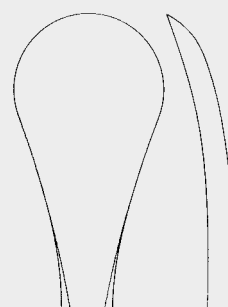

cm	mm
19,0	32-7637-20 20,0



32-7637-20

32.69

Knochenhebel
 Bone Levers
 Leviers à os
 Elevadores para huesos
 Elevatori per ossa

KNOCHENCHIRURGIE

BONE SURGERY

CHIRURGIE OSSEUSE

CIRUGÍA ÓSEA

CHIRURGIA OSSEA



mm	—	D'AUBIGNE 23,0 cm	—
10,0	32-7638-10		32-7639-10
12,0	32-7638-12		32-7639-12



mm	Mc GLAMRY 16,5 cm
11	32-7641-11
13	32-7641-13
15	32-7641-15
17	32-7641-17



mm x mm	FUKUDA 18,0 cm
32,0 x 81,0	32-7681-32
38,0 x 81,0	32-7681-38



cm	MEYERDING
33,0	32-7687-33



cm	MURPHY LANE	mm
30,0	32-7689-30	25,0



32-7638-10

32.70

Knochenhebel
Bone Levers
Leviers à os
Elevadores para huesos
Elevatori per ossa



BENNETT
32-7701-71
65 x 240 mm

BENNETT
32-7701-73
45 x 240 mm

mm WAGNER 22,0 cm
17 32-7910-22

mm HOHMANN 22,0 cm
17 32-7916-17

mm x mm **MERLE D'AUBIGNE**
40 x 20 32-7703-20
40 x 30 32-7703-30

mm SCHUHMACHER WAGNER 34,5 cm
37 32-7920-37

KNOCHENCHIRURGIE

BONE SURGERY

CHIRURGIE OSSEUSE

CIRUGÍA ÓSEA

CHIRURGIA OSSEA



mm 29,0 cm
40 32-7924-29

mm 30,0 cm
22 32-7826-30

mm HOHMANN ALDINGER 27,0 cm
24 32-7930-24

24,0 cm
32-7936-22
32-7936-28
32-7936-40

24,0 cm
32-7940-28
32-7940-40



32-7940-40

32.71

Knochenhebel
 Bone Levers
 Leviers à os
 Elevadores para huesos
 Elevatori per ossa

KNOCHENCHIRURGIE

BONE SURGERY

CHIRURGIE OSSEUSE

CIRUGÍA ÓSEA

CHIRURGIA OSSEA

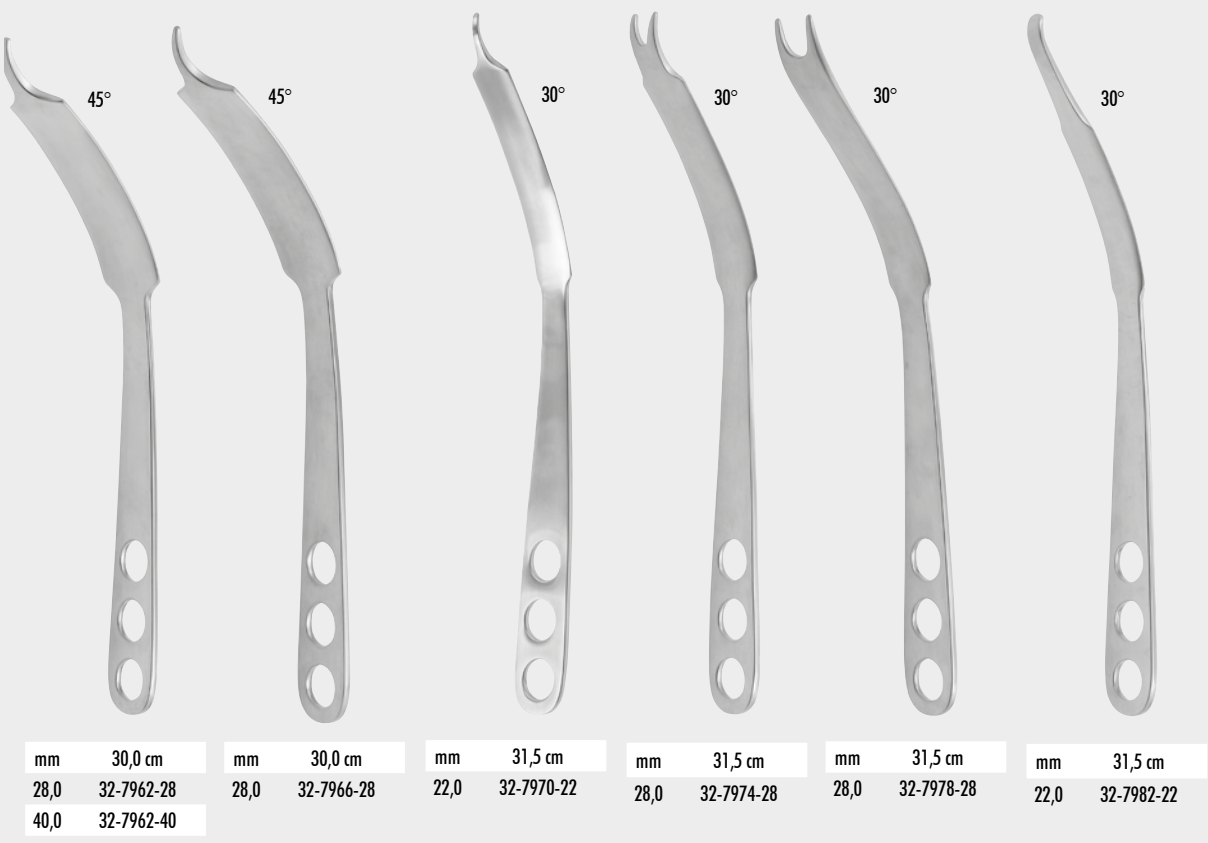
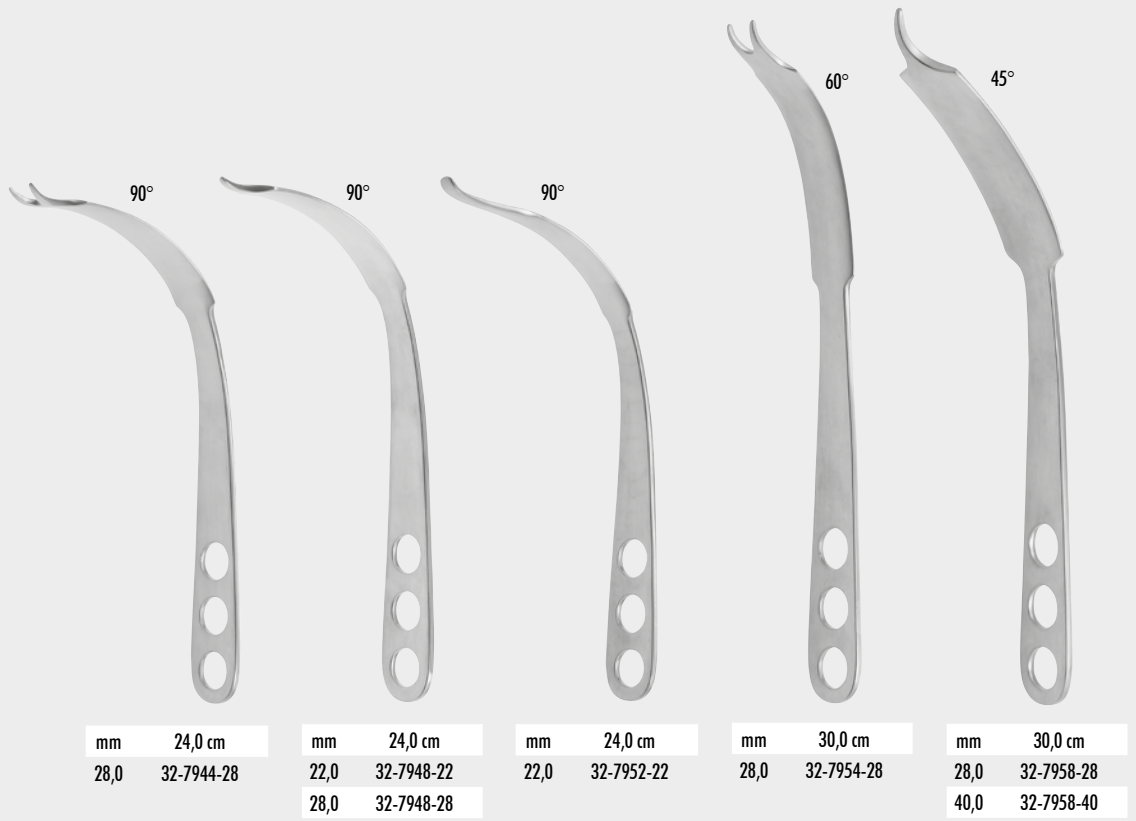

32-7944-28

32.72

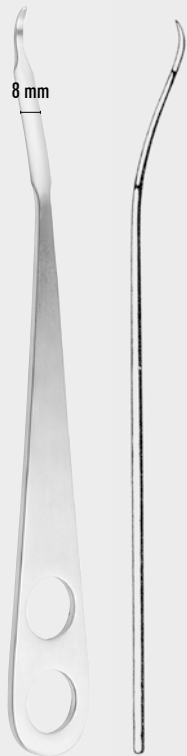

8 mm

mm HOHMANN
8,0 32-8001-08



18 mm

mm HOHMANN
18,0 32-8001-17 - 32-8001-18



32-8001-17



32-8001-18



43 mm

mm VERBRUEGGE HOHMANN (MÜLLER)
43,0 32-8001-43



70 mm

mm HOHMANN
70,0 32-8001-70



43 mm

mm HOHMANN
43,0 32-8003-43

Knochenhebel
Bone Levers
Leviers à os
Elevadores para huesos
Elevatori per ossa

KNOCHENCHIRURGIE

BONE SURGERY

CHIRURGIE OSSEUSE

CIRUGÍA ÓSEA

CHIRURGIA OSSEA



32-8003-43

32.73

Knochenhebel
 Bone Levers
 Leviers à os
 Elevadores para huesos
 Elevatori per ossa

KNOCHENCHIRURGIE

BONE SURGERY

CHIRURGIE OSSEUSE

CIRUGÍA ÓSEA

CHIRURGIA OSSEA



mm HOHMANN
 22,0 32-8005-22

mm HOHMANN
 33,0 32-8005-33

mm HOHMANN
 24,0 32-8007-24

mm LANGE HOHMANN
 22,0 32-8009-22



mm	LANGE HOHMANN modif	cm
30,0	32-8011-27	26,5
33,0	32-8011-28	28,0

mm	HOHMANN ACETABULUM	cm
40,0	32-8013-40	33,0

mm	cm
27,5	32-8015-24
24,0	

mm	cm
18,0	32-8017-18
22,0	



32-8005-22

32.74



mm	AUFRANC Cobra	cm
32,0	32-8021-01	26,0



mm	AUFRANC Cobra	cm
32,0	32-8021-02	26,0



mm	AUFRANC Cobra	cm
32,0	32-8021-03	26,0

Knochenhebel
Bone Levers
Leviers à os
Elevadores para huesos
Elevatori per ossa

KNOCHENCHIRURGIE

BONE SURGERY

CHIRURGIE OSSEUSE

CIRUGÍA ÓSEA

CHIRURGIA OSSEA



mm	32-8101-06
6,0	



mm	32-8101-08
8,0	



cm	HOHMANN mini
16,0	32-8101-06 - 32-8101-08

cm	HAYES
13,0	32-8103-13
16,0	32-8103-16
13,0 mm x 38,0 mm	

ZEPF[®]
α
INSTRUMENTS

32-8103-16

32.75

Knochenhebel
 Bone Levers
 Leviers à os
 Elevadores para huesos
 Elevatori per ossa

KNOCHENCHIRURGIE

BONE SURGERY

CHIRURGIE OSSEUSE

CIRUGÍA ÓSEA

CHIRURGIA OSSEA

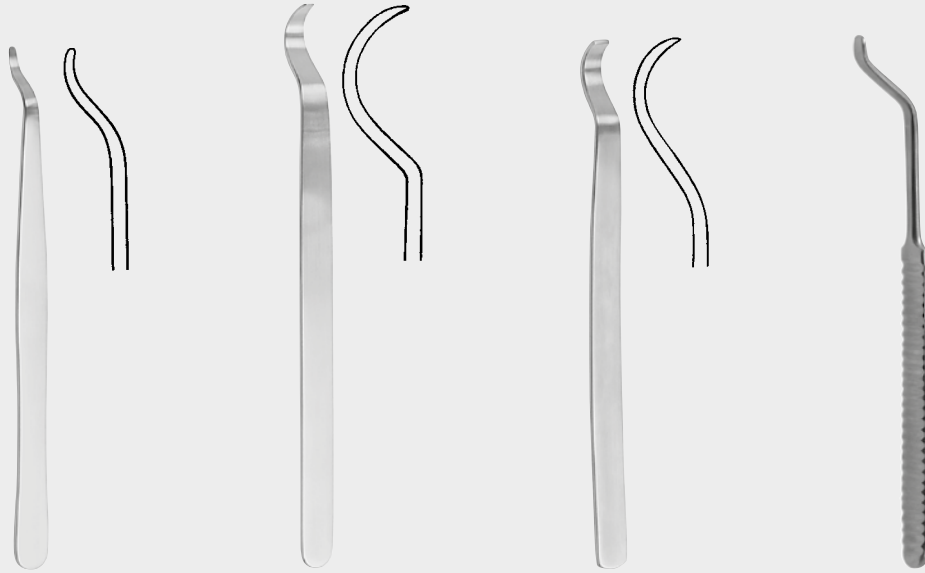

mm		cm
2,8	32-8105-28	14,0

mm		cm
4,5	32-8105-45	15,0

mm		cm
6,0	32-8105-60	15,0

mm		cm
5,5	32-8107-55	15,5



mm	BUCK GRAMCKO	cm
7,5	32-8109-15	15,0



mm		cm
15,0	32-8111-15	16,0



mm		cm
16,0	32-8113-16	12,0



32-8105-28

32.76

Knochenhebel
 Bone Levers
 Leviers à os
 Elevadores para huesos
 Elevatori per ossa

KNOCHENCHIRURGIE

BONE SURGERY

CHIRURGIE OSSEUSE

CIRUGÍA ÓSEA

CHIRURGIA OSSEA



cm LANE
 25,0 32-8115-25



cm TREHOWAN
 21,5 32-8117-21



cm WATSON-JONES
 23,5 32-8121-23



cm WATSON-JONES
 28,0 32-8123-28



cm ALDERDYCE
 21,0 32-8137-21



cm BLOUNT
 26,0 32-8203-26



cm BLOUNT
 26,0 32-8205-26

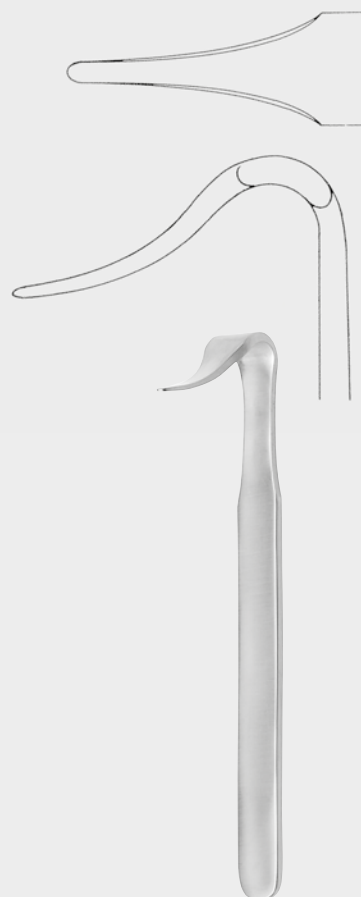

cm BLOUNT
 17,5 32-8207-17



Meniskus-Wundhaken
Knee Retractors
Ecarteurs à genou
Separadores para rodilla
Divaricatori per ginocchio

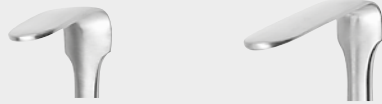

mm
19 x 32 32-8208-32

mm
19 x 45 32-8208-45

mm
19 x 60 32-8208-60



cm SMILLIE
14,0 32-8208-32 - 32-8208-60

mm SMILLIE 14,0 cm
13 x 55 32-8209-55

mm SMILLIE 14,0 cm
13 x 15 32-8211-15
13 x 25 32-8211-25

Fig. TRILLAT 24,0 cm
1 32-8213-01

KNOCHENCHIRURGIE

BONE SURGERY

CHIRURGIE OSSEUSE

CIRUGÍA ÓSEA

CHIRURGIA OSSEA

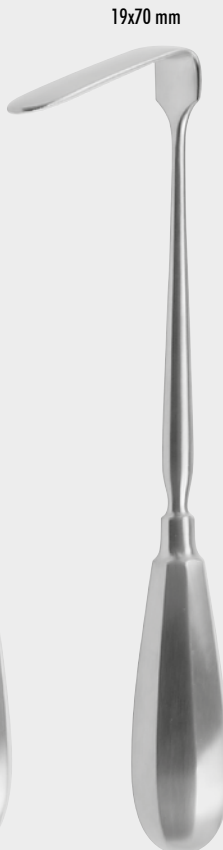

Spinalhaken
Spinal Retractor
Ecarteur spinal
Separador espinal
Divaricatore spinale



Fig. TRILLAT 24,0 cm
2 32-8213-02

cm JACKSON BURROWS
22,5 32-8221-22

cm JACKSON BURROWS
22,5 32-8223-22

mm TAYLOR 16,5 cm
75 x 30 32-8301-16
100 x 30 32-8303-16

cm LANE
27,0 32-8305-27



32-8208-32

32.78



cm SMILLIE
17,0 32-9100-17



« 32-9101-17



32-9103-17 »



cm BIRCHER
19,0 32-9105-19



cm BIRCHER
19,0 32-9107-19

Meniskotome
Meniscotomes
Méniscotomes
Meniscótomos
Meniscotomi

KNOCHENCHIRURGIE

BONE SURGERY

CHIRURGIE OSSEUSE

CIRUGÍA ÓSEA

CHIRURGIA OSSEA



cm DOWNING
25,0 32-9109-25

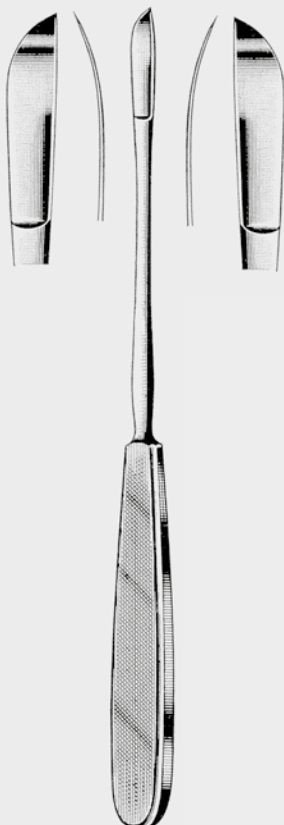

cm « NEFF »
22,0 32-9201-22 32-9203-22

ZEPF®
INSTRUMENTS

32-9203-22

32.79

Meniskotome
Meniscotomes
Méniscotomes
Meniscótomos
Meniscotomi

KNOCHENCHIRURGIE

BONE SURGERY

CHIRURGIE OSSEUSE

CIRUGÍA ÓSEA

CHIRURGIA OSSEA



cm CANADA «
20,0 32-9205-20



cm CANADA »
20,0 32-9207-20



cm SALENIUS
22,0 32-9211-22



cm SALENIUS
22,0 32-9213-22

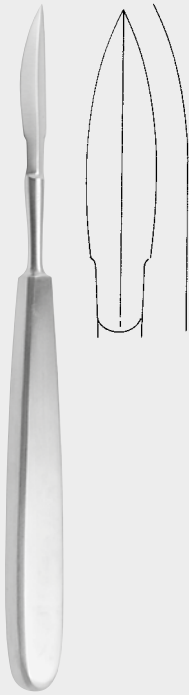

cm
18,0 32-9221-18



32-9205-20

32.80



- Fig. 1
32-9500-01
- Fig. 2
32-9500-02
- Fig. 3
32-9500-03
- Fig. 4
32-9500-04
- Fig. 5
32-9500-05

cm **BUNNELL**
15,0 32-9500-01 - 32-9500-05



- ø mm
4,0 32-9502-40
- ø mm
4,5 32-9502-45
- ø mm
5,5 32-9502-55

cm
23,0 32-9502-40 - 32-9502-45



cm **BUNNELL**
23,0 32-9506-23

Sehnenstripper
Tendon Strippers
Ecorcheurs pour tendons
Separadores para tendones
Scollatendini

KNOCHENCHIRURGIE

BONE SURGERY

CHIRURGIE OSSEUSE

CIRUGÍA ÓSEA

CHIRURGIA OSSEA



cm
28,0 32-9691-28



cm
24,5 32-9701-24



cm
22,0 32-9702-22



cm **PUTTI**
27,0 32-9703-27



cm **PUTTI**
30,0 32-9705-30

Knochenraspeln und -feilen
Bone Rasps and Bone Files
Râpes à os et limes à os
Escofinas y limas para huesos
Raspe e lime per ossa



32-9705-30

32.81

Knochenmühle
Bone Mill
Moulin à os
Molino para huesos
Mulino per ossa

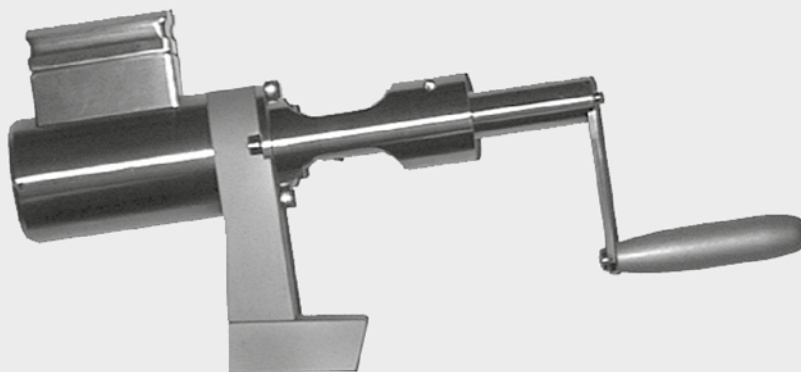

cm
42,0 32-9900-00

Basismodell, bestehend aus Knochenmühle und Handkurbel, ohne Schneidtrommel und ohne Op-Tisch-Befestigungsvorrichtung
Basic Equipment, consisting of bone mill and crank, without cutting drum, without OR table fixation clamp
Modèle de base, consistant de moulin à os et manivelle, sans tambour coupant, sans dispositif de fixation à la table d'op
Modelo de base, compuesto de molino para huesos y manivela, sin tambor cortante, sin dispositivo de fijación a la mesa operatoria
Modello di base, composto da mulino per ossa e manivella, senza tambore tagliante, senza dispositivo di fissaggio al tavolo di operazione

KNOCHENCHIRURGIE

BONE SURGERY

CHIRURGIE OSSEUSE

CIRUGÍA ÓSEA

CHIRURGIA OSSEA

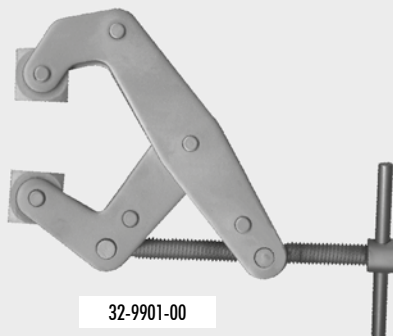

32-9901-00

Spannklammer zum Anbringen der Knochenmühle am Op-Tisch
Clamp to fix bone mill to OR table
Dispositif pour fixer le moulin à la table d'op
Dispositivo para fijar el molino a la mesa operatoria
Dispositivo per fissare il mulino al tavolo di operazione

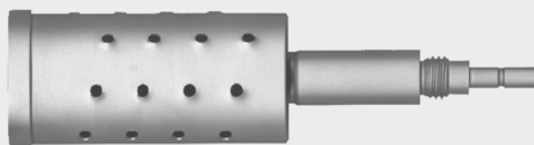

ø mm
4,2 32-9900-04

4 Schneiden in Reihe, Bohrungsdurchmesser 4,2 mm
4 cutters in line, diam. of hole 4,2 mm
4 orifices de coupe en ligne, diam. du trou 4,2 mm
4 orificios de corte en línea, diám. del orificio 4,2 mm
4 fori taglianti in linea, diam. dei fori 4,2 mm

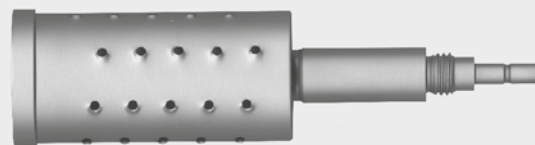

ø mm
3,2 32-9900-05

5 Schneiden in Reihe, Bohrungsdurchmesser 3,2 mm
5 cutters in line, diam. of hole 3,2 mm
5 orifices de coupe en ligne, diam. du trou 3,2 mm
5 orificios de corte en línea, diám. del orificio 3,2 mm
5 fori taglianti in linea, diam. dei fori 3,2 mm

Schneidtrommeln
Cutting Drums
Tambours coupants
Tambores cortantes
Tambori taglianti

Auf Wunsch ist diese Knochenmühle auch mit Motorenanschluss lieferbar
Upon request, this bone mill is also available motor driven
Sur demande, ce moulin à os est aussi livrable pour fonctionnement avec moteur
A solicitud, este molino para huesos puede también ser entregado para funcionar con motor
A domanda, questo mulino può anche essere fornito per funzionare con motore

Alle Teile komplett aus rostfreiem Stahl
All parts completely from stainless steel
Tous les composants entièrement réalisés en acier inoxydable
Todos los componentes completamente de acero inoxidable
Tutti i componenti interamente in acciaio inossidabile

ZEPF[®]
α
INSTRUMENTS

32-9900-00 - 32-9900-05

32.82

KNOCHENCHIRURGIE, TRAUMATOLOGIE

BONE SURGERY, TRAUMATOLOGY

CHIRURGIE OSSEUSE, TRAUMATOLOGIE

CIRUGÍA ÓSEA, TRAUMATOLOGÍA

CHIRURGIA OSSEA, TRAUMATOLOGIA

Amputation
Amputation
Amputation
Amputación
Amputazione



compl.
33-1001-01

Komprimeter zur Erzeugung einer Blutleere in den Gliedern
Compression Apparatus for producing blood vacuum in the limbs
Appareil compressif permettant d'obtenir un milieu exsangue des membres
Aparato de compresión para producir el vacío de sangre en los miembros
Vacometro per determinare vuoti di sangue nelle membra

KNOCHENCHIRURGIE,
TRAUMATOLOGIE

BONE SURGERY,
TRAUMATOLOGY

CHIRURGIE OSSEUSE,
TRAUMATOLOGIE

CIRUGÍA ÓSEA,
TRAUMATOLOGÍA

CHIRURGIA OSSEA,
TRAUMATOLOGIA



PERCY
33-1098-00



PERCY
33-1100-00



HELFERICH-BIER
33-1101-39

Komplett mit 3 Blättern 5, 6 und 8 mm
Complete with 3 blades 5, 6, and 8 mm
Complète avec 3 lames 5, 6 et 8 mm
Completa con 3 hojas de 5, 6 y 8 mm
Completa di 3 lame 5, 6 e 8 mm

mm	
5	33-1101-05
6	33-1101-06
8	33-1101-08

ZEPF[®]
α
INSTRUMENTS

33-1001-01

33.2



mm
12 33-1102-12
15 33-1102-15
18 33-1102-18

CHARRIERE (FARABEUF)
33-1102-00

Kompl. m. 2 Blättern 12 u. 15 mm
Compl. w. 2 blades 12 and 15 mm
Compl. av. 2 lames 12 et 15 mm
Compl. c. 2 hojas 12 y 15 mm
Compl. di 2 lame 12 e 15 mm



RUST
33-1104-00

mm
6 33-1104-06
8 33-1104-08
15 33-1104-15
20 33-1104-20

cm
27,0 33-1106-98
30,0 33-1106-99

Blätter
blades
lames
hoja
hame



cm **CHARRIERE**
27,0 33-1106-27
30,0 33-1106-30

Blätter
blades
lames
hoja
hame

33-1108-99



cm **SATTERLEE**
31,0 33-1108-31

cm **LANGENBECK**
23,0 33-1200-23



**KNOCHENCHIRURGIE,
TRAUMATOLOGIE**

**BONE SURGERY,
TRAUMATOLOGY**

**CHIRURGIE OSSEUSE,
TRAUMATOLOGIE**

**CIRUGÍA ÓSEA,
TRAUMATOLOGÍA**

**CHIRURGIA OSSEA,
TRAUMATOLOGIA**

Finger Instrumente
Finger Instruments
Instruments à doigts
Instrumentos para dedos
Strumenti per dita

Set 3=

33-1600-01

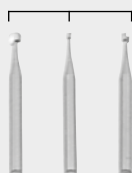

33-1600-00
compl. incl. 33-1600-01

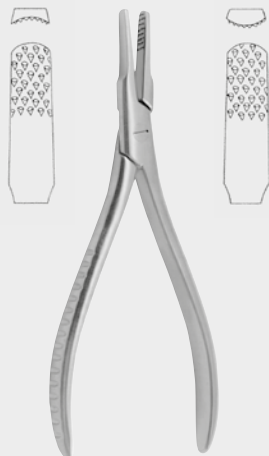

cm **RADOLF**
13,5 33-1602-13



cm **PENNER**
16,0 33-1604-16



cm
14,5 33-1606-14

ZEPF®
INSTRUMENTS

33-1606-14

33.3

Amputation
Amputation
Amputation
Amputación
Amputazione

KNOCHENCHIRURGIE,
TRAUMATOLOGIE

BONE SURGERY,
TRAUMATOLOGY

CHIRURGIE OSSEUSE,
TRAUMATOLOGIE

CIRUGÍA ÓSEA,
TRAUMATOLOGÍA

CHIRURGIA OSSEA,
TRAUMATOLOGIA



cm WALTON
16,0 33-1701-00



cm
17,0 33-1703-00



33-1705-00



cm FELDHEIM
10,0 33-1710-10



cm STILLE compl.
20,0 33-2100-20

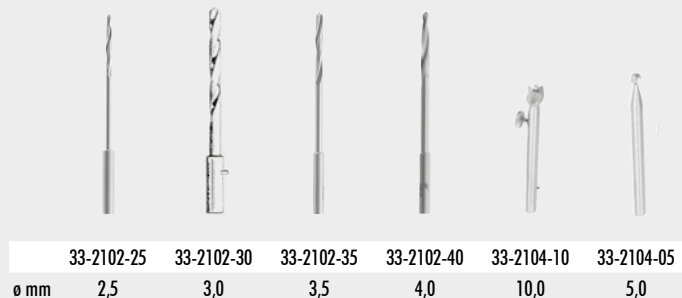

	33-2102-25	33-2102-30	33-2102-35	33-2102-40	33-2104-10	33-2104-05
ø mm	2,5	3,0	3,5	4,0	10,0	5,0



	33-2104-08	33-2104-12	33-2104-16	33-2106-10	33-2106-15	33-2106-20
ø mm	8,0	12,0	16,0	1,0	1,5	2,0

Handbohrapparate
Bone Hand Drills
Perforateurs à main
Perforadores a mano
Perforatori a mano

KNOCHENCHIRURGIE,
TRAUMATOLOGIE

BONE SURGERY,
TRAUMATOLOGY

CHIRURGIE OSSEUSE,
TRAUMATOLOGIE

CIRUGÍA ÓSEA,
TRAUMATOLOGÍA

CHIRURGIA OSSEA,
TRAUMATOLOGIA

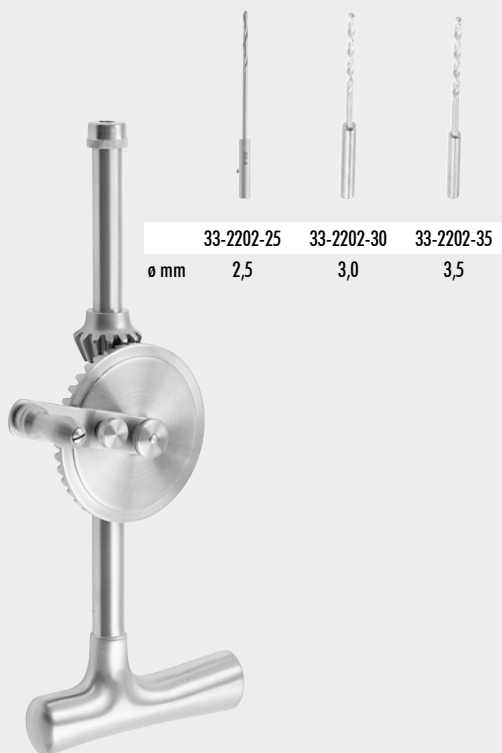

cm STILLE SHERMAN compl.
24,0 33-2200-24

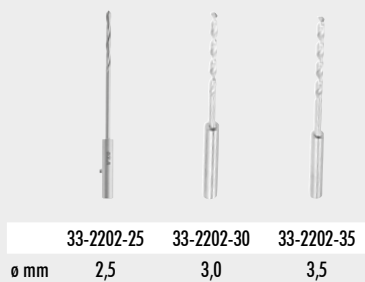

	33-2202-25	33-2202-30	33-2202-35
ø mm	2,5	3,0	3,5



Set / 3
33-2302-00



cm MOORE compl.
28,0 33-2300-28



33-2300-28

33.5



Handbohrapparate
Bone Hand Drills
Perforateurs à main
Perforadores a mano
Perforatori a mano

KNOCHENCHIRURGIE,
TRAUMATOLOGIE

BONE SURGERY,
TRAUMATOLOGY

CHIRURGIE OSSEUSE,
TRAUMATOLOGIE

CIRUGÍA ÓSEA,
TRAUMATOLOGÍA

CHIRURGIA OSSEA,
TRAUMATOLOGIA



cm
27,0 33-2400-99

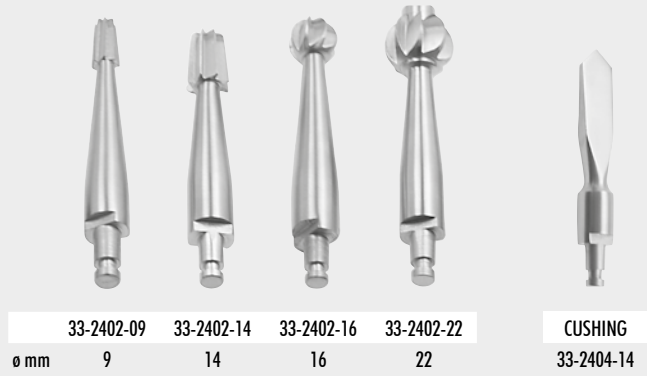

	33-2402-09	33-2402-14	33-2402-16	33-2402-22	CUSHING
ø mm	9	14	16	22	33-2404-14

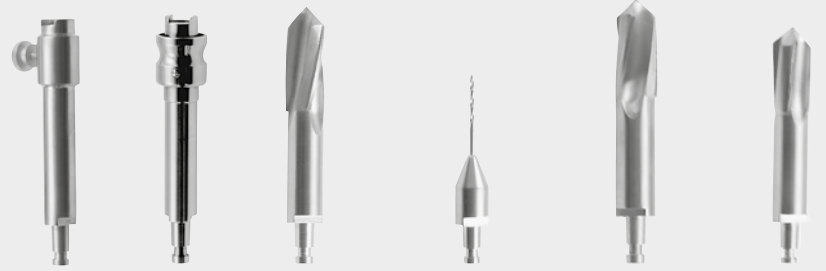

cm	HUDSON compl.		McKENZIE	ø mm	McKENZIE	ø mm	McKENZIE	ø mm	D'ERRICO
27,0	33-2400-27	33-2406-00	33-2406-01	2,0	33-2410-02	13,0	33-2412-13	16,0	33-2414-16

incl. 33-2402-09 / -14 / -16 / -22 / 33-2406-00



HUDSON
33-2450-01



HUDSON
33-2450-10



ø mm	CUSHING
10	33-2452-10
12	33-2452-12
15	33-2452-15



ø mm	LEWIS
10	33-2454-10
12	33-2454-12
15	33-2454-15



ø mm	
11	33-2456-11
13	33-2456-13
16	33-2456-16



33-2400-27

33.6

Handbohrapparate
Bone Hand Drills
Perforateurs à main
Perforadores a mano
Perforatori a mano



ø mm	CUSHING	ø mm	MC KENZIE	ø mm	MC KENZIE
11	33-2458-11	16	33-2460-16	16	33-2462-00
13	33-2458-13				
16	33-2458-16				
19	33-2458-19				
22	33-2458-22				

KNOCHENCHIRURGIE,
TRAUMATOLOGIE

BONE SURGERY,
TRAUMATOLOGY

CHIRURGIE OSSEUSE,
TRAUMATOLOGIE

CIRUGÍA ÓSEA,
TRAUMATOLOGÍA

CHIRURGIA OSSEA,
TRAUMATOLOGIA



KIRSCHNER compl.
33-2500-00

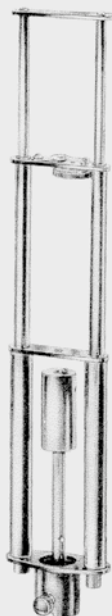

33-2502-00
Teleskopische Bohrdrahtstütze
Telescopic Wire Drill Guide
Guide de broches télescopant
Conductor telescópico p. taladros filiformes
Condottoe a telescopio per taladri filiformi



compl.
33-2600-00



33-2602-00
Teleskopische Bohrdrahtstütze
Telescopic Wire Drill Guide
Guide de broches télescopant
Conductor telescópico p. taladros filiformes
Condottoe a telescopio per taladri filiformi



Handbohrapparate
Bone Hand Drills
Perforateurs à main
Perforadores a mano
Perforatori a mano



cm BUNNELL
16,0 33-2700-00

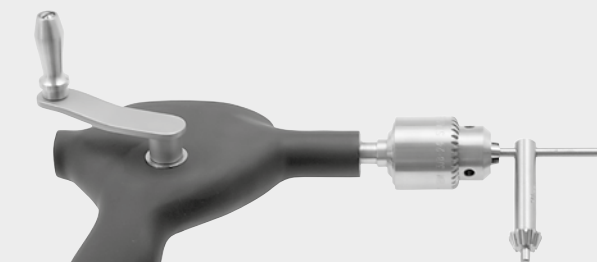

RALK
33-2800-00
33-2810-00

Lange Welle
long shaft
arbre lay
arbol Largo
albero Lungo

KNOCHENCHIRURGIE,
TRAUMATOLOGIE

BONE SURGERY,
TRAUMATOLOGY

CHIRURGIE OSSEUSE,
TRAUMATOLOGIE

CIRUGÍA ÓSEA,
TRAUMATOLOGÍA

CHIRURGIA OSSEA,
TRAUMATOLOGIA



33-2900-00



33-2906-00



33-2910-00
cap. 6,35 mm · L = 125 mm

Schlüssellos
keyless
sans clé
sin llave
senza chiave

ZEPF[®]
α
INSTRUMENTS

33-2700-00

33.8

Bohrer-, Fräser-, Sägen-Besteck
 Set of Saws, Drills, and Burrs
 Jeu de scies, mèches et fraises
 Juego de sierras, taladros y fresas
 Set di seghe, perforatori e frese

**KNOCHENCHIRURGIE,
 TRAUMATOLOGIE**

**BONE SURGERY,
 TRAUMATOLOGY**

**CHIRURGIE OSSEUSE,
 TRAUMATOLOGIE**

**CIRUGÍA ÓSEA,
 TRAUMATOLOGÍA**

**CHIRURGIA OSSEA,
 TRAUMATOLOGIA**

Knochenbohrer
 Bone Drills
 Mèches à os
 Taladros para huesos
 Trapani per ossa

ZEPF®

 INSTRUMENTS

33-3507-45

33.9



ø mm	cyl.
1,0	33-3504-10
1,2	
1,5	33-3504-15
1,8	
2,0	33-3504-20
2,2	
2,5	33-3504-25
2,8	33-3504-28
3,0	33-3504-30
3,2	33-3504-32
3,5	33-3504-35
4,0	33-3504-40
4,5	33-3504-45
5,0	33-3504-50
6,0	33-3504-60
7,0	

ø mm	mm	cyl.	AO	AO
1,1	60 / 35		33-3506-11	
1,5	85 / 60		33-3506-15	
1,5	110 / 85			33-3507-15
2,0	100 / 75		33-3506-20	
2,0	125 / 100			33-3507-20
2,5	110 / 85		33-3506-25	
2,7	100 / 75		33-3506-27	
2,7	125 / 100			33-3507-27
3,2	145 / 120		33-3506-32	
3,2	180 / 165	33-3505-32		
3,2	195 / 170			33-3507-32
3,5	110 / 85			
3,5	180 / 165	33-3505-35		
3,5	195 / 170			33-3507-35
4,5	145 / 120		33-3506-45	
4,5	180 / 165	33-3505-45		
4,5	195 / 170			33-3507-45
6,0	195 / 170		33-3506-60	

Gewindebohrer, Handstücke
 Taps, Tap and Drill Holders
 Tarauds, Poignées pour tarauds et mèches
 Terrajas, mangos para terrajas y taladros
 Maschi, manici per maschi e trapani

**KNOCHENCHIRURGIE,
 TRAUMATOLOGIE**

**BONE SURGERY,
 TRAUMATOLOGY**

**CHIRURGIE OSSEUSE,
 TRAUMATOLOGIE**

**CIRUGÍA ÓSEA,
 TRAUMATOLOGÍA**

**CHIRURGIA OSSEA,
 TRAUMATOLOGIA**



ø mm	s	l	xl
1,5		33-3510-15	
2,0		33-3510-20	33-3511-20
2,7		33-3510-27	33-3511-27
3,5		33-3510-35 cort.	
3,5		33-3512-35 spong.	
4,5	33-3510-45		33-3511-45 1,25
4,5			33-3512-45 1,75
6,5		33-3510-65	



ø mm	s	l	
2,7	33-3514-27		
3,5	33-3514-35	33-3515-35	1,25
3,5	33-3515-35		1,75
4,0	33-3514-40		1,75
4,5	33-3514-45	33-3515-14	
6,5	33-3514-65		

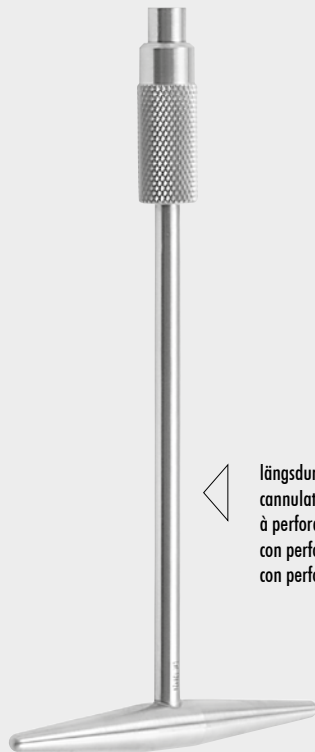

33-3518-00



33-3520-00

längsdurchbohrt
 cannulated
 à perforation longitudinale
 con perforación longitudinal
 con perforazione longitudinale



33-3522-00



33-3524-00



Fräser, Trephine
 Burrs, Trephine
 Fraises, Trépan
 Fresas, Trefina
 Frese, Trefina

ø mm	DOYEN	DOYEN	DOYEN	DOYEN	ALBEE	ALBEE	BORCHARDT	TOTI
4,0	33-3602-04	33-3604-04						
6,0	33-3602-06	33-3604-06						
7,0						33-3704-07		
8,0	33-3602-08	33-3604-08		33-3608-08	33-3702-08			33-3708-08
10,0	33-3602-10	33-3604-10		33-3608-10	33-3702-10			
12,0	33-3602-12	33-3604-12	33-3606-12		33-3700-12	33-3702-12		
13,0							33-3706-13	
14,0	33-3602-14	33-3604-14			33-3700-15			
15,0								
16,0	33-3602-16	33-3604-16						
25,0								33-3707-25

KNOCHENCHIRURGIE,
 TRAUMATOLOGIE

BONE SURGERY,
 TRAUMATOLOGY

CHIRURGIE OSSEUSE,
 TRAUMATOLOGIE

CIRUGÍA ÓSEA,
 TRAUMATOLOGÍA

CHIRURGIA OSSEA,
 TRAUMATOLOGIA



compl.
 33-3807-00

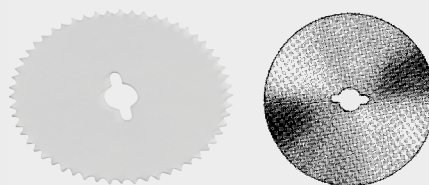
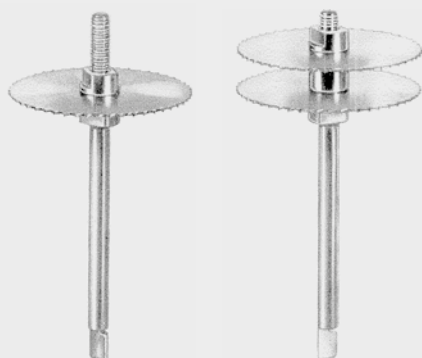

Set
 33-3808-00

ø mm			
17,0			33-3806-17
20,0	33-3800-20	33-3802-20	33-3804-20
22,0			33-3806-22
25,0	33-3800-25	33-3802-25	33-3804-25
27,0			33-3806-27
30,0	33-3800-30	33-3802-30	33-3804-30
32,0			33-3806-32
35,0	33-3800-35	33-3802-35	33-3804-35
37,0			33-3806-37
40,0	33-3800-40	33-3802-40	33-3804-40
42,0			33-3806-42
45,0	33-3800-45	33-3802-45	33-3804-45
47,0			33-3806-47
50,0	33-3800-50	33-3802-50	33-3804-50

Kreissägen für Chirurgie-Handmotor
 Circular Saws for Surgical Hand Motor
 Scies circulaires pour moteur à main
 Sierras circulares para motor a mano
 Seghe circolari per motore a mano

ZEPF[®]

 INSTRUMENTS

33-3808-00

33.11

Pfrieme
Reamers
Alésoirs
Escariadores
Alesatori

KNOCHENCHIRURGIE,
TRAUMATOLOGIE

BONE SURGERY,
TRAUMATOLOGY

CHIRURGIE OSSEUSE,
TRAUMATOLOGIE

CIRUGÍA ÓSEA,
TRAUMATOLOGÍA

CHIRURGIA OSSEA,
TRAUMATOLOGIA

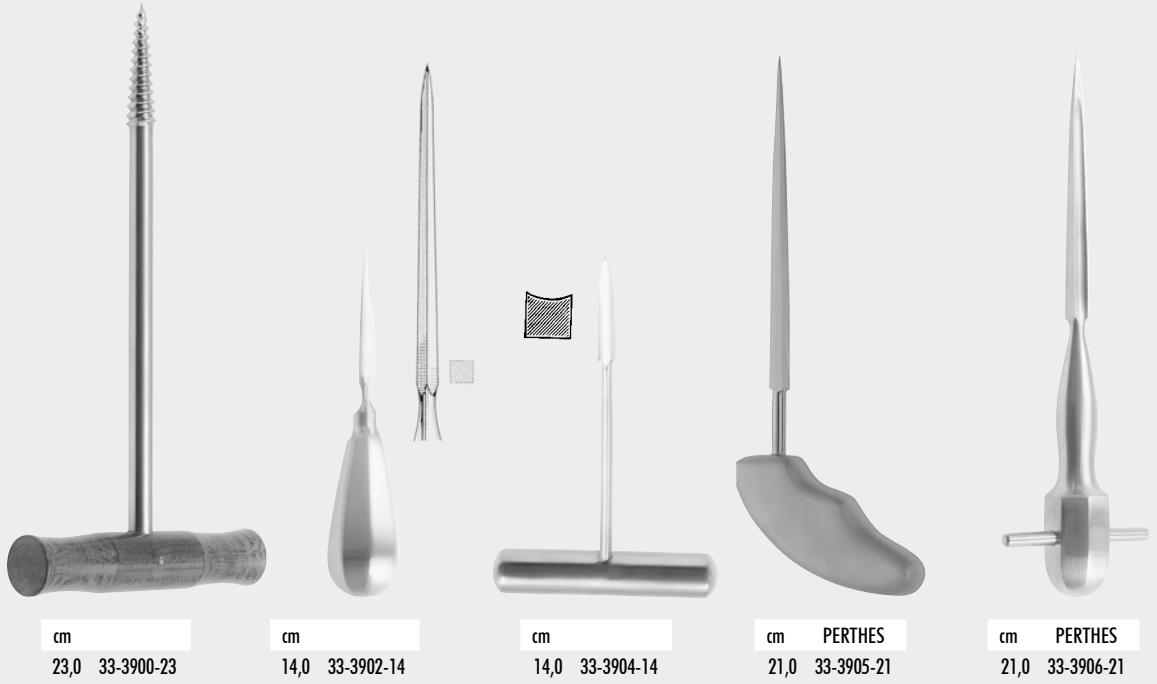

cm 23,0 33-3900-23

cm 14,0 33-3902-14

cm 14,0 33-3904-14

cm PERTHES 21,0 33-3905-21

cm PERTHES 21,0 33-3906-21



cm ISSELIN 16,5 33-3908-16



cm ISSELIN 16,5 33-3910-16



mm 16,5 cm
2 33-3912-02
3 33-3912-03



mm x mm 18,0 cm
3 x 3 33-3914-03
4 x 4 33-3914-04
5 x 5 33-3914-05
6 x 6 33-3914-06
8 x 8 33-3914-08
10 x 10 33-3914-10



mm x mm 25,0 cm
3 x 3 33-3916-03
4 x 4 33-3916-04
5 x 5 33-3916-05
6 x 6 33-3916-06
8 x 8 33-3916-08
10 x 10 33-3916-10



mm x mm	30,0 cm
3 x 3	33-3918-03
4 x 4	33-3918-04
5 x 5	33-3918-05
6 x 6	33-3918-06
8 x 8	33-3918-08
10 x 10	33-3918-10



mm x mm	OMBREDANNE 18,5 cm
3 x 3	33-3920-03
4 x 4	33-3920-04
5 x 5	33-3920-05
6 x 6	33-3920-06



mm x mm	OMBREDANNE 25,0 cm
3 x 3	33-3922-03
4 x 4	33-3922-04
5 x 5	33-3922-05
6 x 6	33-3922-06

Příeme
Reamers
Alésoirs
Escariadores
Alesatori



ø mm	70 mm	150 mm	310 mm
0,8	33-4010-08	33-4012-08	33-4020-08
0,9		33-4012-09	33-4020-09
1,0	33-4010-10	33-4012-10	33-4020-10
1,2		33-4012-12	33-4020-12
1,3		33-4012-13	33-4020-13
1,4		33-4012-14	33-4020-14
1,5	33-4010-15	33-4012-15	33-4020-15
1,6		33-4012-16	33-4020-16
1,8		33-4012-18	33-4020-18
2,0		33-4012-20	33-4020-20
2,2		33-4012-22	33-4020-22
2,5	33-4010-25	33-4012-25	33-4020-25
3,0		33-4012-30	33-4020-30



ø mm	150 mm	310 mm
0,8	33-4022-08	33-4024-08
1,0	33-4022-10	33-4024-10
1,2	33-4022-12	33-4024-12
1,4	33-4022-14	33-4024-14
1,5	33-4022-15	33-4024-15
1,6	33-4022-16	33-4024-16
1,8	33-4022-18	33-4024-18
2,0	33-4022-20	33-4024-20
2,2	33-4022-22	33-4024-22
2,5	33-4022-25	33-4024-25

Länge des Gewindes
Length of thread
Longueur filet
Largo de la rosca
Lunghezza del filetto



ø mm	mm	150 mm	200 mm	230 mm
1,6	5	33-4030-16		
1,6	15	33-4032-16		
2,0	15	33-4034-20		
2,0	15		33-4036-20	
2,5	15		33-4038-20	
2,5	20			33-4038-23

KNOCHENCHIRURGIE,
TRAUMATOLOGIE

BONE SURGERY,
TRAUMATOLOGY

CHIRURGIE OSSEUSE,
TRAUMATOLOGIE

CIRUGÍA ÓSEA,
TRAUMATOLOGÍA

CHIRURGIA OSSEA,
TRAUMATOLOGIA

KIRSCHNER Bohrdrähte
KIRSCHNER Wire Drills
KIRSCHNER Broches
KIRSCHNER Taladros filiformes
KIRSCHNER Fili

Spitze: Trocar
Tip: Trocar
Pointe: Trocart
Punta: Trócar
Punta: Trequarti
Ende: Rund
Rear End: Round
Bout: Rond
Cabo: Redondo
Capo: Rotondo

Trokarspitze beide Seiten
Both Sides Trocar Tips
Pointes trocar des deux côtés
Puntas de trócar en los dos lados
Punte a trequarti ambedue lati

Spitze: Trocar mit Gewinde
Tip: Trocar with thread
Pointe: Trocart avec filet
Punta: Trócar con rosca
Punta: Trequarti filettato
Ende: Rund
Rear End: Round
Bout: Rond
Cabo: Redondo
Capo: Rotondo

ZEPF[®]
INSTRUMENTS

33-4038-23

33.13

* nicht kalibriert
not calibrated
pas calibré
no calibrado
non calibrato

STEINMANN Nägel
STEINMANN Pins
STEINMANN Clous à os
STEINMANN Clavos para huesos
STREINMANN Chiodi per ossa



Ø mm KIRSCHNER
0,7 - 3,0 33-4038-90 *

KNOCHENCHIRURGIE, TRAUMATOLOGIE

BONE SURGERY, TRAUMATOLOGY

CHIRURGIE OSSEUSE, TRAUMATOLOGIE

CIRUGÍA ÓSEA, TRAUMATOLOGÍA

CHIRURGIA OSSEA, TRAUMATOLOGIA

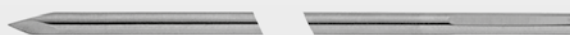

Ø mm	120 mm	150 mm	180 mm	200 mm	250 mm	300 mm
3,5	33-4039-12	33-4039-15	33-4039-18	33-4039-20	33-4039-25	33-4039-30
4,0	33-4040-12	33-4040-15	33-4040-18	33-4040-20	33-4040-25	33-4040-30
4,5	33-4045-12	33-4045-15	33-4045-18	33-4045-20	33-4045-25	33-4045-30
5,0	33-4050-12	33-4050-15	33-4050-18	33-4050-20	33-4050-25	33-4050-30

Spitze: Trokar Ende: Dreikant
Tip: Trocar Rear: Triangular Shaft
Pointe: Trocart Bout: Triangulaire
Punta: Trócar Cabo: Triangular
Punta: a trequarti Capo: Triangolare

In Packungen zu 5 Stück
In packages of 5 ea.
En paquets de 5 pièces
En paquetes de 5 c/u
In pacchi di 5 pezzi



Ø mm	150 mm	180 mm	200 mm	230 mm	250 mm	300 mm
3,0	33-4130-15	33-4130-18	33-4130-20	33-4130-23		
3,5	33-4135-15	33-4135-18	33-4135-20	33-4135-23		
4,0	33-4140-15	33-4140-18	33-4140-20	33-4140-23	33-4140-25	
4,5	33-4145-15	33-4145-18	33-4145-20	33-4145-23	33-4145-25	33-4145-30
5,0	33-4150-15	33-4150-18	33-4150-20	33-4150-23	33-4150-25	33-4150-30

Spitze: Trokar Ende: Dreikant mit zentralem Gewinde (Durchmesser 0,5 mm größer als Schaft)
Tip: Trocar Rear: Triangular Shaft with central thread (Diam. 0,5 mm more than shaft)
Pointe: Trocart Bout: Triangulaire avec filet central (Diam. 0,5 mm supérieur à la tige)
Punta: Trócar Cabo: Triangular con rosca central (Diám. 0,5 mm superior al clavo)
Punta: a trequarti Capo: Triangolare con filetto centrale (Diam. 0,5 mm superiore al chiodo)

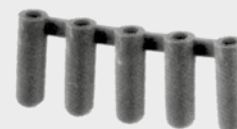

Ø mm	
3,0	33-4159-97
4,0	33-4159-98
5,0	33-4159-99

Schutzkappen
Tip Protectors
Protecteurs de la pointe
Protectores de la punta
Protettori della punta

ZEPF[®]
α
INSTRUMENTS

33-4038-90

33.14

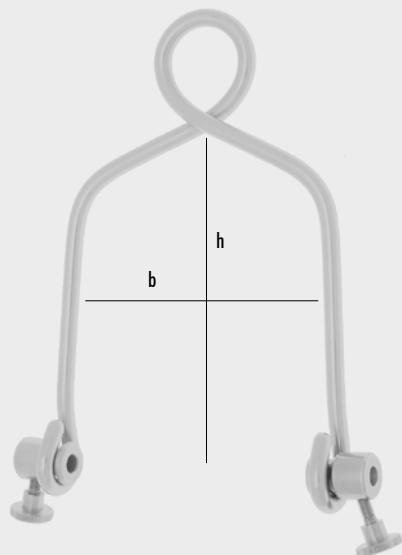

Mit 3 Zughaken
With 3 Hooks
Avec 3 crochets
Con 3 ganchos
Con 3 uncini



SW 14/17
33-5105-01



33-5105-02

h x b cm	BOEHLER
16 x 9	33-5002-16
21 x 11	33-5002-21
21 x 15	33-5002-22

h x b cm	KIRSCHNER
6,0 x 5,0	33-5102-06
9,5 x 7,0	33-5102-09
10,5 x 10,5	33-5102-10
9,5 x 11,0	33-5102-11
12,0 x 12,0	33-5102-12
13,5 x 13,0	33-5102-13
15,5 x 15,5	33-5102-15
20,0 x 15,5	33-5102-20

Extensionsbügel
Extension Bows
Étriers à extension
Estribos para extensión
Archi per estensione

KNOCHENCHIRURGIE,
TRAUMATOLOGIE

BONE SURGERY,
TRAUMATOLOGY

CHIRURGIE OSSEUSE,
TRAUMATOLOGIE

CIRUGÍA ÓSEA,
TRAUMATOLOGÍA

CHIRURGIA OSSEA,
TRAUMATOLOGIA



33-5109-01

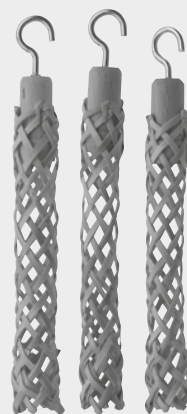

Fig. 1 Fig. 2 Fig. 3

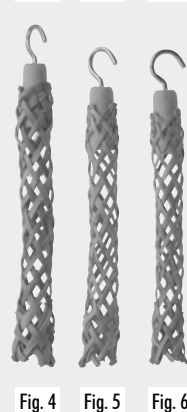

Fig. 4 Fig. 5 Fig. 6

h x b cm	
18 x 10	33-5104-18
27 x 16	33-5104-27

Mit 3 Zughaken
With 3 Hooks
Avec 3 crochets
Con 3 ganchos
Con 3 uncini

cm	KIRSCHNER U.S.
S 13,0	33-5108-01
L 18,5	33-5108-02
XL 22,0	33-5108-03

33-5109-02
Zughaken allein
Hooks only
Crochets seuls
Ganchos sueltos
Uncini soli

Fig.	
1 L	33-5202-01
2 M	33-5202-02
3 S	33-5202-03
	Für Finger
	For Fingers
	Pour doigts
	Para dedos
	Per dita

Fig.	
1	33-5204-01
2	33-5204-02
3	33-5204-03
4	33-5204-04
5	33-5204-05
6	33-5204-06

Fingerhülsen aus Bast

Extensionsbügel
Extension Bows
Étriers à extension
Estribos para extensión
Archi per estensione

ZEPF[®]
INSTRUMENTS

33-5204-06

33.15



Instrumente für Knochendraht
 Instruments for Bone Wire
 Instruments pour le fil à os
 Instrumentos para huesos
 Strumenti per ossa

**KNOCHENCHIRURGIE,
 TRAUMATOLOGIE**

**BONE SURGERY,
 TRAUMATOLOGY**

**CHIRURGIE OSSEUSE,
 TRAUMATOLOGIE**

**CIRUGÍA ÓSEA,
 TRAUMATOLOGÍA**

**CHIRURGIA OSSEA,
 TRAUMATOLOGIA**

Knochendraht und -Instrumente
 Bone Wire and Instruments
 Fil à os et instruments
 Hilo para huesos e instrumentos
 Filo per ossa e strumenti

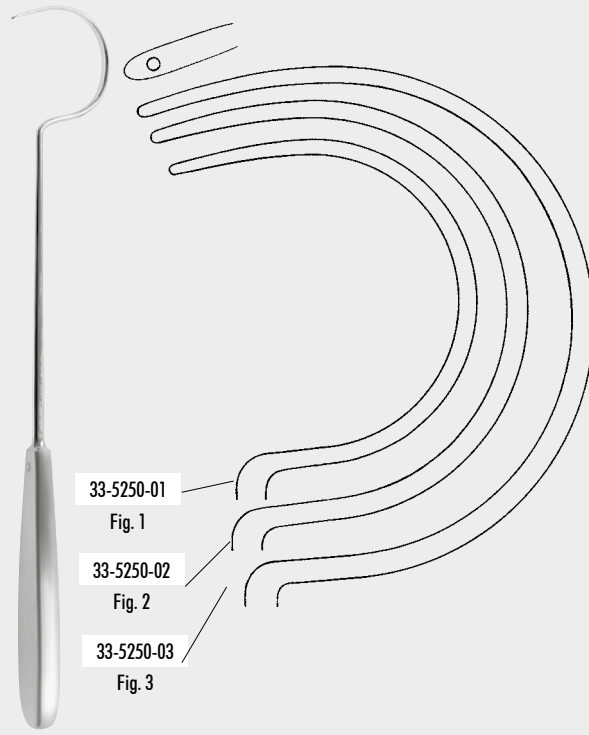

DEMEL
 33-5250-01 - 33-5250-03



cm DEMEL
 28,0 33-5254-28



cm DANIS
 20,0 33-5258-20



ø mm	ø mm	cm	DANIS	cm	DANIS	cm	DANIS	cm	DANIS	cm	DANIS
45	70	17,0	33-5262-17	19,0	33-5262-19	21,0	33-5262-21	24,0	33-5263-24	27,0	33-5263-27



33-5250-16

33.16

Knochendraht und -Instrumente
 Bone Wire and Instruments
 Fil à os et instruments
 Hilo para huesos e instrumentos
 Filo per ossa e strumenti

KNOCHENCHIRURGIE,
 TRAUMATOLOGIE

BONE SURGERY,
 TRAUMATOLOGY

CHIRURGIE OSSEUSE,
 TRAUMATOLOGIE

CIRUGÍA ÓSEA,
 TRAUMATOLOGÍA

CHIRURGIA OSSEA,
 TRAUMATOLOGIA

Knochendraht weich, mit Öse
 Bone Wire, soft, with eye
 Fil à os, souple, avec œil
 Hilo p. huesos, blando, con ojo
 Filo p. ossa, morbido, con ansa



Knochendraht, weich
 Bone Wire, Soft
 Fil à os, souple - Hilo p.
 huesos blando - Filo p. ossa
 morbido

ø mm	
0,2	33-5300-02
0,3	33-5300-03
0,4	33-5300-04
0,5	33-5300-05
0,6	33-5300-06
0,7	33-5300-07
0,8	33-5300-08
0,9	33-5300-09
1,0	33-5300-10
1,1	33-5300-11
1,2	33-5300-12
1,5	33-5300-15



cm	LOUTE
21,0	33-5301-21

l = cm		ø mm
28,0	33-5291-08	0,8
28,0	33-5291-10	1,0
28,0	33-5291-12	1,2
60,0	33-5292-10	1,0
60,0	33-5292-12	1,2

ZEPF[®]

 INSTRUMENTS

33-5301-21

33.17



Drahtfasszangen, Flachzangen
 Wire Holding Forceps, Flat-Nosed Pliers
 Pinces à saisir le fil métallique, Pinces plates
 Pinzas para agarrar hilo, pinzas de picos chatos
 Pinze per afferrare fili, pinze piatte

**KNOCHENCHIRURGIE,
 TRAUMATOLOGIE**

**BONE SURGERY,
 TRAUMATOLOGY**

**CHIRURGIE OSSEUSE,
 TRAUMATOLOGIE**

**CIRUGÍA ÓSEA,
 TRAUMATOLOGÍA**

**CHIRURGIA OSSEA,
 TRAUMATOLOGIA**



cm
 17,0 33-5302-17



cm VISE GRIP
 18,0 33-5303-18

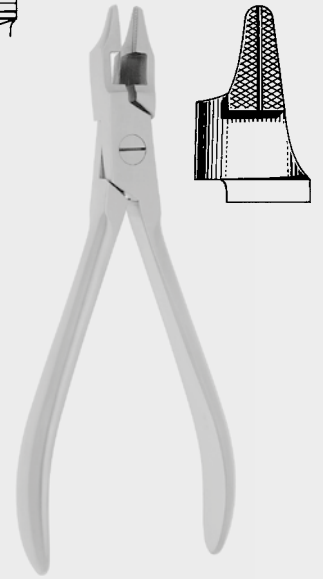

cm
 15,0 33-5304-15



cm
 13,0 33-5305-13
 18,0 33-5305-18



cm
 14,0 33-5306-14



cm
 19,0 33-5306-19



cm
 18,0 33-5307-01 - 33-5307-04

rund
 round
 rond
 redondo
 rondo



Fig.
 1 33-5307-01



Fig.
 2 33-5307-02



Fig.
 3 33-5307-03



Fig.
 4 33-5307-04



33-5302-17

33.18

Mit TC-Einsätzen
 TC Lined
 A mors TC
 Con bocas TC
 Con morso TC



33-5308-01



33-5308-02



cm
 17,0 33-5308-01 - 33-5308-02



cm
 20,0 33-5309-20



cm HACKSTOCK
 16,0 33-5310-16

Drahtfazzangen, Flachzangen
 Wire Holding Forceps, Flat-Nosed Pliers
 Pinces à saisir le fil métallique, Pinces plates
 Pinzas para agarrar hilo, pinzas de picos chatos
 Pinze per afferrare fili, pinze piatte

KNOCHENCHIRURGIE,
 TRAUMATOLOGIE

BONE SURGERY,
 TRAUMATOLOGY

CHIRURGIE OSSEUSE,
 TRAUMATOLOGIE

CIRUGÍA ÓSEA,
 TRAUMATOLOGÍA

CHIRURGIA OSSEA,
 TRAUMATOLOGIA



33-5312-14



33-5314-14



cm
 14,0 33-5312-14 - 33-5314-14



cm
 14,0 33-5315-14



cm
 15,5 33-5316-15
 18,0 33-5316-18



33-5316-18

33.19



Mit TC-Einsätzen
 TC Lined
 A mors TC
 Con bocas TC
 Con morso TC

Draht-Zwirbelzangen
 Wire Twisting Forceps
 Pinces à torsader le fil
 Pinzas para retorcer el hilo
 Pinze per ritorcere fili

KNOCHENCHIRURGIE,
 TRAUMATOLOGIE

BONE SURGERY,
 TRAUMATOLOGY

CHIRURGIE OSSEUSE,
 TRAUMATOLOGIE

CIRUGÍA ÓSEA,
 TRAUMATOLOGÍA

CHIRURGIA OSSEA,
 TRAUMATOLOGIA



cm
 18,0 33-5318-18

cm
 14,5 33-5319-15

mm 22,0 cm
 5 33-5319-22

mm 25,5 cm
 5 33-5319-25

mm 30,0 cm
 7 33-5319-30

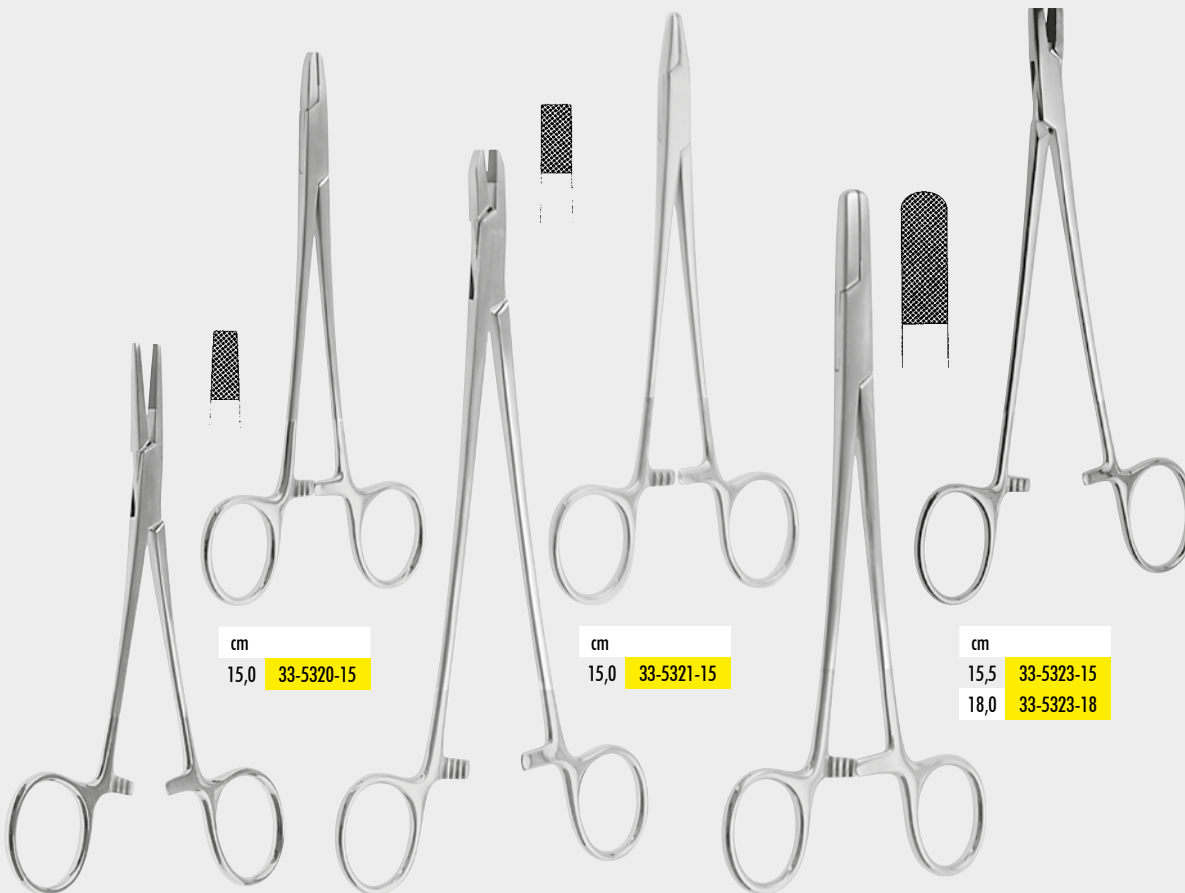

cm
 15,0 33-5320-15

cm
 15,0 33-5321-15

cm
 15,5 33-5323-15
 18,0 33-5323-18

cm
 14,0 33-5320-14

cm
 20,0 33-5320-20

cm
 18,0 33-5322-18



33-5318-18

33.20

Mit TC-Einsätzen
TC Lined
A mors TC
Con bocas TC
Con morso TC



Fig. 1 33-5324-01

cm
18,0 33-5324-01 - 33-5324-03



Fig. 2 33-5324-02



Fig. 3 33-5324-03



mm
5,0 33-5326-18

cm
18,0 33-5326-18 - 33-5328-18

mm
7,0 33-5328-18

Draht-Zwirbelzangen
Wire Twisting Forceps
Pinces à torsader le fil
Pinzas para retorcer el hilo
Pinze per ritorcere fili

KNOCHENCHIRURGIE,
TRAUMATOLOGIE

BONE SURGERY,
TRAUMATOLOGY

CHIRURGIE OSSEUSE,
TRAUMATOLOGIE

CIRUGÍA ÓSEA,
TRAUMATOLOGÍA

CHIRURGIA OSSEA,
TRAUMATOLOGIA

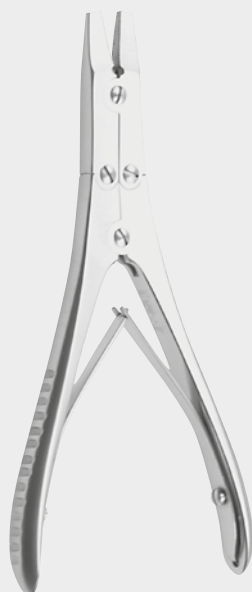

cm
14,0 33-5330-14



cm
14,0 33-5360-14

Für weichen Draht: bis 1,4 mm
Für harten Draht: bis 1,0 mm
For Soft Wire: up to 1,4 mm
For Hard Wire: up to 1,0 mm
Pour fil souple: jusqu'à 1,4 mm
Pour fil dur: jusqu'à 1,0 mm
Para hilo blando: hasta 1,4 mm
Para hilo duro: hasta 1,0 mm
Per filo morbido: fino a 1,4 mm
Per filo duro: fino a 1,0 mm

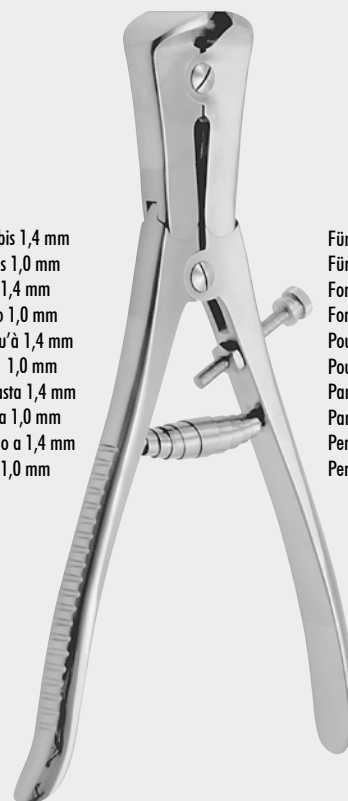

cm
23,0 33-5362-23

Für weichen Draht: bis 3,0 mm
Für harten Draht: bis 2,5 mm
For Soft Wire: up to 3,0 mm
For Hard Wire: up to 2,5 mm
Pour fil souple: jusqu'à 3,0 mm
Pour fil dur: jusqu'à 2,5 mm
Para hilo blando: hasta 3,0 mm
Para hilo duro: hasta 2,5 mm
Per filo morbido: fino a 3,0 mm
Per filo duro: fino a 2,5 mm

ZEPF®
INSTRUMENTS

33-5362-23

33.21

TC Schneiden
TC Cutting Edges
Tranchant TC
Filos de corte TC
Taglio TC

Drahtschneidezangen
Wire Cutting Forceps
Pincas à couper le fil
Pinzas para cortar alambre
Tronchesi taglafili

KNOCHENCHIRURGIE,
TRAUMATOLOGIE

BONE SURGERY,
TRAUMATOLOGY

CHIRURGIE OSSEUSE,
TRAUMATOLOGIE

CIRUGÍA ÓSEA,
TRAUMATOLOGÍA

CHIRURGIA OSSEA,
TRAUMATOLOGIA

Drahtschneidezangen
Wire Cutting Forceps
Pincas à couper le fil
Pinzas para cortar alambre
Tronchesi taglafili

ZEPF[®]
α
INSTRUMENTS

33-5400-16

33.22



cm Diamant
16,0 33-5400-16

Für weichen Draht: bis 2,2 mm
Für harten Draht: bis 2,0 mm
For Soft Wire: up to 2,2 mm
For Hard Wire: up to 2,0 mm
Pour fil souple: jusqu'à 2,2 mm
Pour fil dur: jusqu'à 2,0 mm
Para hilo blando: hasta 2,2 mm
Para hilo duro: hasta 2,0 mm
Per filo morbido: fino a 2,2 mm
Per filo duro: fino a 2,0 mm

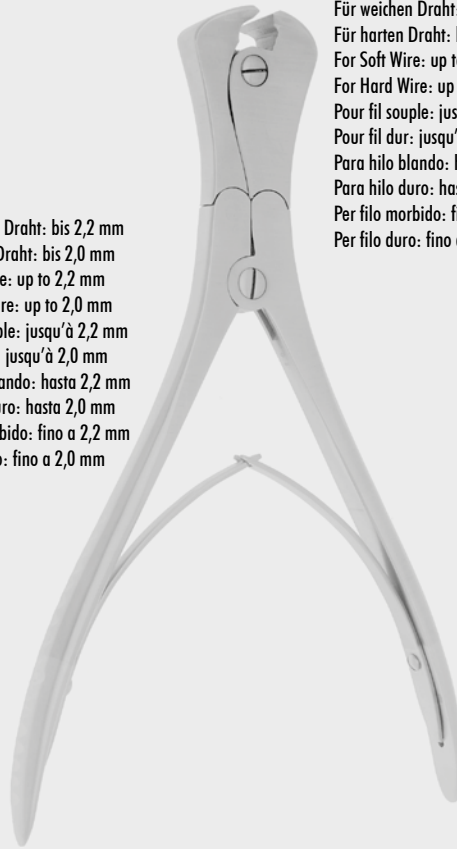

cm
22,0 33-5401-22

Für weichen Draht: bis 3,5 mm
Für harten Draht: bis 2,5 mm
For Soft Wire: up to 3,5 mm
For Hard Wire: up to 2,5 mm
Pour fil souple: jusqu'à 3,5 mm
Pour fil dur: jusqu'à 2,5 mm
Para hilo blando: hasta 3,5 mm
Para hilo duro: hasta 2,5 mm
Per filo morbido: fino a 3,5 mm
Per filo duro: fino a 2,5 mm



cm
15,0 33-5402-15

Für weichen Draht: bis 2,0 mm
Für harten Draht: bis 1,5 mm
For Soft Wire: up to 2,0 mm
For Hard Wire: up to 1,5 mm
Pour fil souple: jusqu'à 2,0 mm
Pour fil dur: jusqu'à 1,5 mm
Para hilo blando: hasta 2,0 mm
Para hilo duro: hasta 1,5 mm
Per filo morbido: fino a 2,0 mm
Per filo duro: fino a 1,5 mm



cm
18,0 33-5405-18

Für weichen Draht: bis 2,0 mm
Für harten Draht: bis 1,6 mm
For Soft Wire: up to 2,0 mm
For Hard Wire: up to 1,6 mm
Pour fil souple: jusqu'à 2,0 mm
Pour fil dur: jusqu'à 1,6 mm
Para hilo blando: hasta 2,0 mm
Para hilo duro: hasta 1,6 mm
Per filo morbido: fino a 2,0 mm
Per filo duro: fino a 1,6 mm



cm
22,0 33-5405-22

Für weichen Draht: bis 2,0 mm
Für harten Draht: bis 1,5 mm
For Soft Wire: up to 2,0 mm
For Hard Wire: up to 1,5 mm
Pour fil souple: jusqu'à 2,0 mm
Pour fil dur: jusqu'à 1,5 mm
Para hilo blando: hasta 2,0 mm
Para hilo duro: hasta 1,5 mm
Per filo morbido: fino a 2,0 mm
Per filo duro: fino a 1,5 mm

TC Schneiden
 TC Cutting Edges
 Tranchant TC
 Filos de corte TC
 Taglio TC

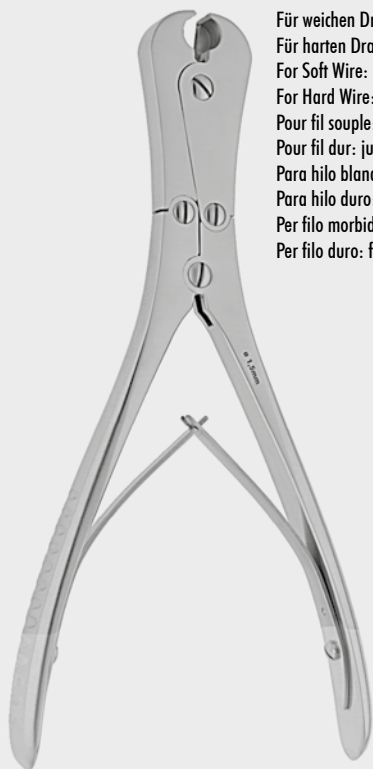

Für weichen Draht: bis 2,0 mm
 Für harten Draht: bis 1,5 mm
 For Soft Wire: up to 2,0 mm
 For Hard Wire: up to 1,5 mm
 Pour fil souple: jusqu'à 2,0 mm
 Pour fil dur: jusqu'à 1,5 mm
 Para hilo blando: hasta 2,0 mm
 Para hilo duro: hasta 1,5 mm
 Per filo morbido: fino a 2,0 mm
 Per filo duro: fino a 1,5 mm

cm
 18,0 33-5406-18



Für weichen Draht: bis 2,0 mm
 Für harten Draht: bis 1,6 mm
 For Soft Wire: up to 2,0 mm
 For Hard Wire: up to 1,6 mm
 Pour fil souple: jusqu'à 2,0 mm
 Pour fil dur: jusqu'à 1,6 mm
 Para hilo blando: hasta 2,0 mm
 Para hilo duro: hasta 1,6 mm
 Per filo morbido: fino a 2,0 mm
 Per filo duro: fino a 1,6 mm

cm REILL
 17,0 33-5407-17

Drahtschneidezangen
 Wire Cutting Forceps
 Pincas à couper le fil
 Pinzas para cortar alambre
 Tronchesi taglafili

KNOCHENCHIRURGIE,
 TRAUMATOLOGIE

BONE SURGERY,
 TRAUMATOLOGY

CHIRURGIE OSSEUSE,
 TRAUMATOLOGIE

CIRUGÍA ÓSEA,
 TRAUMATOLOGÍA

CHIRURGIA OSSEA,
 TRAUMATOLOGIA



33-5408-23



33-5409-23



Für weichen Draht: bis 3,0 mm
 Für harten Draht: bis 2,2 mm
 For Soft Wire: up to 3,0 mm
 For Hard Wire: up to 2,2 mm
 Pour fil souple: jusqu'à 3,0 mm
 Pour fil dur: jusqu'à 2,2 mm
 Para hilo blando: hasta 3,0 mm
 Para hilo duro: hasta 2,2 mm
 Per filo morbido: fino a 3,0 mm
 Per filo duro: fino a 2,2 mm

cm
 23,0 33-5408-23 - 33-5409-23



cm
 16,5 33-5415-16

ZEPF®

 INSTRUMENTS

33-5415-16

33.23



Mit TC-Einsätzen
TC Lined
A mors TC
Con bocas TC
Con morso TC

Für weichen Draht: bis 2,0 mm
Für harten Draht: bis 1,6 mm
For Soft Wire: up to 2,0 mm
For Hard Wire: up to 1,6 mm
Pour fil souple: jusqu'à 2,0 mm
Pour fil dur: jusqu'à 1,6 mm
Para hilo blando: hasta 2,0 mm
Para hilo duro: hasta 1,6 mm
Per filo morbido: fino a 2,0 mm
Per filo duro: fino a 1,6 mm

Für weichen Draht: bis 2,0 mm
Für harten Draht: bis 1,6 mm
For Soft Wire: up to 2,0 mm
For Hard Wire: up to 1,6 mm
Pour fil souple: jusqu'à 2,0 mm
Pour fil dur: jusqu'à 1,6 mm
Para hilo blando: hasta 2,0 mm
Para hilo duro: hasta 1,6 mm
Per filo morbido: fino a 2,0 mm
Per filo duro: fino a 1,6 mm

Kapazität bis 6 mm
Capacity up to 6 mm
Capacité jusqu'à 6 mm
Capacidad hasta 6 mm
Capacità fino a 6 mm

Drahtschneidezangen
Wire Cutting Forceps
Pinces à couper le fil
Pinzas para cortar alambre
Tronchesi tagliafili

KNOCHENCHIRURGIE,
TRAUMATOLOGIE

BONE SURGERY,
TRAUMATOLOGY

CHIRURGIE OSSEUSE,
TRAUMATOLOGIE

CIRUGÍA ÓSEA,
TRAUMATOLOGÍA

CHIRURGIA OSSEA,
TRAUMATOLOGIA

Instrumente zur Knochenagelung
Bone Nailing Instruments
Instruments pour l'enclouage des os
Instrumentos para el enclavamiento de huesos
Strumenti per il inchiodamento di ossa



Durchbohrt
Cannulated
Canulée
Canulada
Cannulata

cm
18,0 33-5500-18



cm
17,0 33-5502-17



cm
24,0 33-5505-24

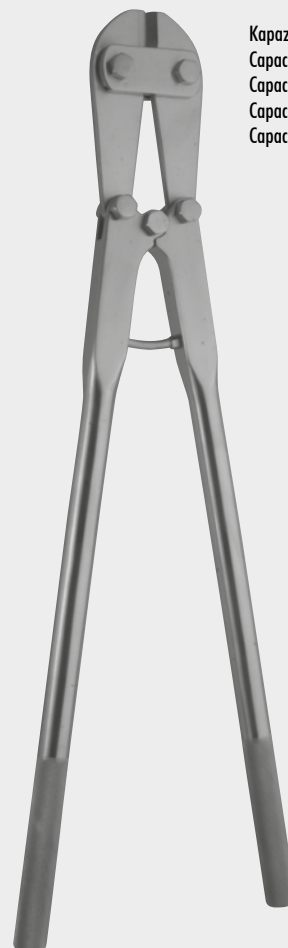

cm
48,0 33-5506-48 33-5508-48
56,0 33-5506-56



ø mm	
2,4	33-5600-24
3,2	33-5600-32
4,8	33-5600-48
6,4	33-5600-64



f. p. ø mm	
2,4	33-5602-24
3,2	33-5602-32
4,8	33-5602-48
6,4	33-5602-64



mm	KUENTSCHER 26,0 cm
8,0	33-5701-08
10,0	33-5701-10
12,5	33-5701-12



cm	KUENTSCHER
35,0	33-5703-35



33-5500-18

33.24

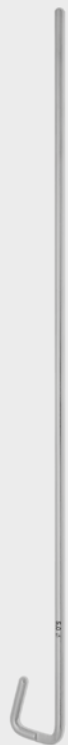

Fig. KUENTSCHER
1 33-5900-01

Fig. KUENTSCHER
2 33-5900-02

Instrumente zur Knochnagelung
Bone Nailing Instruments
Instruments pour l'enclouage des os
Instrumentos para el enclavamiento de huesos
Strumenti per il inchiodamento di ossa

ø mm	L=35 cm	L=46 cm	L=60 cm
2,5	33-5801-35	33-5801-46	
3,0	33-5802-35	33-5802-46	33-5802-60
3,5	33-5803-35	33-5803-46	33-5803-60
4,0	33-5804-35	33-5804-46	33-5804-60
5,0	33-5805-35	33-5805-46	33-5805-60

cm KUENTSCHER
21,0 33-5806-21

mm KUENTSCHER 21,0 cm
6-8 33-5807-13
9-12 33-5807-17
13-20 33-5807-21

cm KUENTSCHER
56,0 33-5900-00

KNOCHENCHIRURGIE,
TRAUMATOLOGIE

BONE SURGERY,
TRAUMATOLOGY

CHIRURGIE OSSEUSE,
TRAUMATOLOGIE

CIRUGÍA ÓSEA,
TRAUMATOLOGÍA

CHIRURGIA OSSEA,
TRAUMATOLOGIA



L cm
29,0 33-5906-29
37,0 33-5906-37
42,0 33-5906-42
49,0 33-5906-49

33-5908-30

cm LLOYD
20,0 33-6002-20





Schraubendreher
Screw Drivers
Tournevis
Destornilladores
Giravite

KNOCHENCHIRURGIE,
TRAUMATOLOGIE

BONE SURGERY,
TRAUMATOLOGY

CHIRURGIE OSSEUSE,
TRAUMATOLOGIE

CIRUGÍA ÓSEA,
TRAUMATOLOGÍA

CHIRURGIA OSSEA,
TRAUMATOLOGIA



cm WILLIAMS
24,0 33-6204-24



SW mm
1,5 33-6208-15



SW mm
2,5 33-6208-25
3,5 33-6208-35



PHILLIPS
33-6212-25



cm
17,0 33-6214-17
25,0 33-6214-25



SW mm
1,5 33-6259-15



SW mm
2,5 33-6259-25



SW mm
3,5 33-6259-35



SW mm
1,5 33-6300-15

33-6300-98



SW mm
2,5 33-6300-25

33-6300-99



LANE
33-6302-25



33-6204-24

33.26



cm
12,0 33-6303-13

cm
18,0 33-6305-18

cm
23,0 33-6307-23

cm
22,0 33-6309-22

cm
8,0 33-6350-08

Haltezange für kleine Plättchen
Holding Forceps for Small Plates
Pince à saisir les petites plaques
Pinza para sostener placas pequeñas
Pinza per afferrare placche piccole

Schraubenhaltepinzette, selbsthaltend
Screw Holding Forceps, Self-Retaining
Pince porte-vis automatique
Pinza porta-tornillos
Pinza porta-viti

Instrumente für Knochenplatten und -schrauben
Instruments for Bone Plates and Screws
Instruments pour plaques et vis osseuses
Instrumentos para placas y tornillos para huesos
Strumenti per placche e viti per ossa

KNOCHENCHIRURGIE,
TRAUMATOLOGIE

BONE SURGERY,
TRAUMATOLOGY

CHIRURGIE OSSEUSE,
TRAUMATOLOGIE

CIRUGÍA ÓSEA,
TRAUMATOLOGÍA

CHIRURGIA OSSEA,
TRAUMATOLOGIA



cm
13,0 33-6402-00

cm
14,5 33-6403-01

cm
14,5 33-6403-02

cm
25,0 33-6405-00

cm
14,0 33-6498-14

cm
14,0 33-6500-14

Schränkeisen für kleine Knochenplatten
Bending Irons for Small Bone Plates
Instruments pour courber les petites plaques
Instrumentos para doblar placas pequeñas
Strumenti per piegare placche piccole



33-6500-14

33.27

Instrumente für Knochenplatten
Instruments for Bone Plates
Instruments pour plaques osseuses
Instrumentos para placas óseas
Strumenti per placche per ossa

KNOCHENCHIRURGIE, TRAUMATOLOGIE

BONE SURGERY, TRAUMATOLOGY

CHIRURGIE OSSEUSE, TRAUMATOLOGIE

CIRUGÍA ÓSEA, TRAUMATOLOGÍA

CHIRURGIA OSSEA, TRAUMATOLOGIA

Instrumente zur Osteosynthese
Osteosynthesis Instruments
Instruments pour l'ostéosynthèse
Instrumentos para osteosíntesis
Strumenti per osteosintesi



cm
22,0 33-6502-22

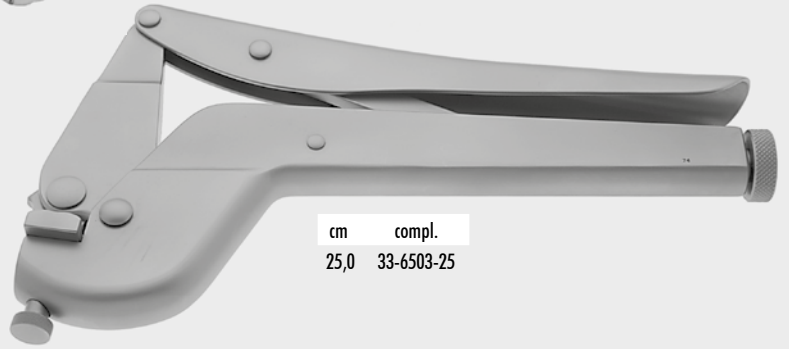
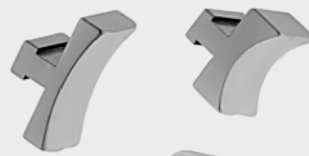

cm compl.
25,0 33-6503-25



33-6700-00

Biegeschablone für Knochenplatten
Bending template for bone plates
Patron pour plier les plaques à os
Patrón para doblar placas para huesos
Padrone per piegare placche per ossa



33-6704-09 - 33-6706-08

mm	mm	
5	90	33-6704-09
7	120	33-6704-12
9	150	33-6704-15
12	200	33-6704-20
7	60	33-6706-06
9	85	33-6706-08

A



160 mm

Knochenbohrer längsdurchbohrt
Drill bit cannulated
Mèche à os perforée longitudinalement
Taladro perforado longitudinalmente
Perforatore forato longitudinalmente

ø mm	A mm	
2,7	1,35	33-7900-27
3,2	1,75	33-7900-32
3,5	1,35	33-7900-35
4,5	1,75	33-7900-45
5,0	2,0	33-7900-50



33-7910-27

2,7 / 1,0 mm

Kleine Bohrbüchse
Tap Sleeve and drill sleeve
Guide-taraud et guide-mèche
Guía de broca y de terraja
Guida di perforatore e di maschio

ZEPF[®]
α
INSTRUMENTS

33-6502-22

33.28

* nicht kalibriert
not calibrated
pas calibré
no calibrado
non calibrato

Gewindeschneider, Schraubendreher
Taps and Screwdrivers
Tarauds et tourne-vis
Terrañas y destornilladores
Maschiettori e giraviti



ø mm	
3,5	33-8102-35
4,0	33-8102-40
4,5	33-8102-45
7,0	33-8102-70



33-8104-00

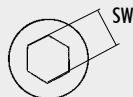

33-8107-25
33-8107-35

SW	
2,5 mm	33-8106-25
3,5 mm	33-8106-35

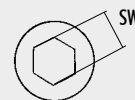

SW	
5,0 mm	33-8106-50

KNOCHENCHIRURGIE,
TRAUMATOLOGIE

BONE SURGERY,
TRAUMATOLOGY

CHIRURGIE OSSEUSE,
TRAUMATOLOGIE

CIRUGÍA ÓSEA,
TRAUMATOLOGÍA

CHIRURGIA OSSEA,
TRAUMATOLOGIA

Instrumente zur Osteosynthese
Osteosynthesis Instruments
Instruments pour l'ostéosynthese
Instrumentos para osteosíntesis
Strumenti per osteosintesi

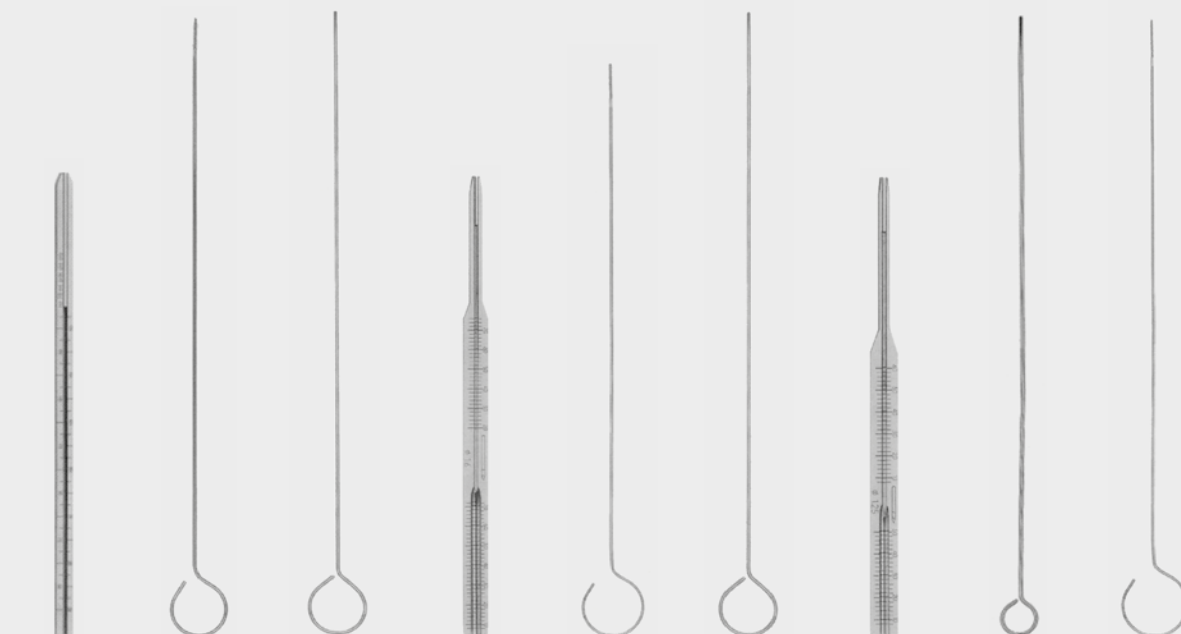

33-8110-70 *	33-8111-21	33-8112-20	33-8114-45 *	33-8115-17	33-8116-16	33-8120-35 *	33-8121-12	33-8121-13
7,0 mm	2,1 mm	2,0 mm	4,5 mm	1,75 mm	1,6 mm	3,5 mm	1,2 mm	1,35 mm

Direkt-Längenmesslehren für Hohlschrauben mit Kanalbürsten und -reinigern
Direct screw length gauges for cannulated screws with canal brushes and canal cleaners
Mesureurs de longueur pour les vis à perforations longitudinales avec ses brosses et nettoyeurs des canaux
Medidores del largo de los tornillos con perforaciones longitudinales con sus cepillos y limpiadores de los canales
Misuratori della lunghezza delle viti con canali longitudinali con i suoi spazzole e pulitori dei canali

ZEPF[®]
α
INSTRUMENTS

33-8121-13

33.29



Instrumente zur Osteosynthese
Osteosynthesis Instruments
Instruments pour l'ostéosynthèse
Instrumentos para osteosíntesis
Strumenti per osteosintesi

**KNOCHENCHIRURGIE,
TRAUMATOLOGIE**

**BONE SURGERY,
TRAUMATOLOGY**

**CHIRURGIE OSSEUSE,
TRAUMATOLOGIE**

**CIRUGÍA ÓSEA,
TRAUMATOLOGÍA**

**CHIRURGIA OSSEA,
TRAUMATOLOGIA**

Kopfraumfräser
Countersinks
Forets-aléseurs
Avellanadores
Alesatori



33-8192-00

7,0 mm

Parallel-Zielgerät für Führungsdrähte ø 2,0 mm
Parallel aiming device for guide wires ø 2,0 mm
Viseur parallèle pour des broches ø 2,0 mm
Visor paralelo para taladros filiformes ø 2,0 mm
Visore parallelo per KIRSCHNER aghi ø 2 mm

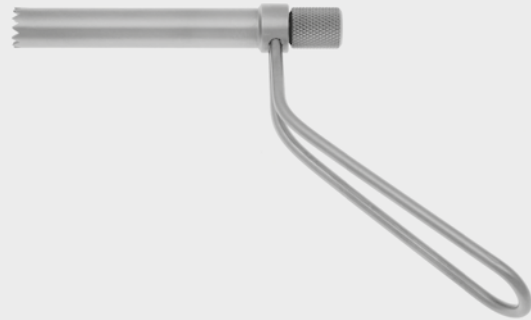

33-8200-00

Gewebeschutzhülse für Hohlschrauben ø 7 mm
Tissue protector sleeve for cannulated screws ø 7 mm
Protecteur de tissu pour les vis à perforation longitudinale ø 7 mm
Protector de tejido para tornillos con perforación longitudinal ø 7 mm
Protettore di tessuto per viti con perforazione longitudinale ø 7 mm

4,5 mm

Für große Schrauben
For large screws
Pour les grandes vis
Para tornillos grandes
Per viti grandi

1,1 mm

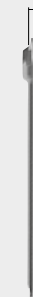

33-8201-11

1,5 / 2,0 mm

Für Mini-Schrauben
For mini screws
Pour les vis mini
Para los tornillos mini
Per viti mini

2,0 mm



33-8202-20

2,7 / 3,5 / 4,0 mm

Für kleine Schrauben
For small screws
Pour les petites vis
Para los tornillos pequeños
Per viti piccole

Malleolar
Malleolar
Malléolaire
Maleolar
Malleolare



33-8204-32

4,5 mm



33-8206-45

4,5 / 6,5 mm



33-8192-00

33.30

* nicht kalibriert
not calibrated
pas calibré
no calibrado
non calibrato

Tiefenmessgeräte, Messschablone
Depth Gauges, Measuring Gauge
Mesureurs de profondeur, de vis
Medidores de profundidad, de tornillos
Misuratori di profondità, di viti

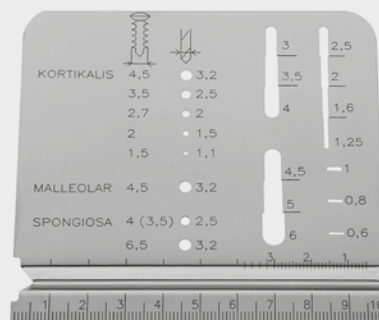

L 15,5 cm 33-8207-00 *	L 15,5 cm 33-8208-00 *	33-8209-01 *
XL 20,5 cm 33-8207-01 *	XL 20,5 cm 33-8208-01 *	

33-8300-00 *

Mini Klein - Small - Petit - Pequeño - Piccolo Groß - Large - Grand Grande - Grande

**KNOCHENCHIRURGIE,
TRAUMATOLOGIE**

**BONE SURGERY,
TRAUMATOLOGY**

**CHIRURGIE OSSEUSE,
TRAUMATOLOGIE**

**CIRUGÍA ÓSEA,
TRAUMATOLOGÍA**

**CHIRURGIA OSSEA,
TRAUMATOLOGIA**



2,0 33-8402-20	33-8410-00	1,1 / 1,5 mm 33-8700-15	33-8702-20	2,7 / 2,0 mm 33-8704-27
2,7 33-8402-27		1,5 / 2,0 mm 33-8700-20	2,0 mm	3,5 / 2,5 mm 33-8704-35
3,5 33-8402-35				4,5 / 3,2 mm 33-8704-45

Halteklammer für Plättchen Holding clamp for small plates Porte-plaque - Porta-placas Portaplacche	Scharfes Häkchen Hooklet sharp Crochet aigu Ganchito agudo Uncinetto acuto	Minibohrbüchse Mini drill sleeve Guide-mèche mini Guía de broca mini Guida di trapano mini	Ziel- und Plattenbohrbüchse Drill guide and drill sleeve Guide-mèche pour viseur Guía-broca para visor Guida di trapano per visore	Steckbohrbüchse Insert drill sleeve Guide-mèche à insérer Guía de broca inyectable Guida di trapano inseribile
---	--	--	--	--

Instrumente zur Osteosynthese
Osteosynthesis Instruments
Instruments pour l'ostéosynthese
Instrumentos para osteosíntesis
Strumenti per osteosintesi



33-8704-45

33.31

Instrumente zur Osteosynthese
Osteosynthesis Instruments
Instruments pour l'ostéosynthèse
Instrumentos para osteosíntesis
Strumenti per osteosintesi

KNOCHENCHIRURGIE,
TRAUMATOLOGIE

BONE SURGERY,
TRAUMATOLOGY

CHIRURGIE OSSEUSE,
TRAUMATOLOGIE

CIRUGÍA ÓSEA,
TRAUMATOLOGÍA

CHIRURGIA OSSEA,
TRAUMATOLOGIA



3,5 mm 33-8800-35
4,5 mm 33-8800-45

Zielgerät mit Gewinde
C-Clamp drill guide with thread
Guide-mèche avec filet
Guía de taladro con rosca
Guida di trapano con filetto



33-8801-45

Zielgerät mit Spitze
Pointed drill guide
Guide-mèche pointu
Guía de taladro puntiaguda
Guida di trapano con punta



33-8803-45

Anschlag-Steckbohrbüchse mit 2 Einsätzen
Drill guide with adjustable stop with 2 inserts
Guide-mèche avec arrêt réglable et 2 adaptateurs
Guía de broca con tope ajustable y 2 injertos
Guida di trapano con arresto regolabile e 2 innesti

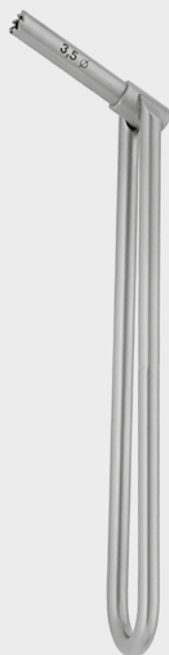

33-8805-35

Gewebeschutzhülse 3,5 mm für
Gewindeschneider 2,7 mm
Tap sleeve 3,5 mm for tap 2,7 mm
Guide-mèche 3,5 mm pour taraud 2,7 mm
Guía de broca 3,5 mm para macho 2,7 mm
Guida di trapano 3,5 mm per
maschiatore 2,7 mm



2,7 / 2,0 mm 33-8807-27
3,5 / 2,5 mm 33-8807-35

Gewebeschutzhülse und Bohrbüchse
für Bohrer und Gewindeschneider
für 3,5 mm Kortikalis-Schrauben
Tap sleeve and drill sleeve for
drill bit and tap for 3,5 mm cortex screws
Guide pour mèches et tarauds pour
des vis corticales 3,5 mm
Guía de broca y de macho para
tornillos corticales 3,5 mm
Guida di trapano e maschiatore per
viti corticali 3,5 mm



4,5 mm 33-8809-45

Gewebeschutzhülse für große Hohlsschrauben
Tap sleeve for large cannulated screws
Guide-mèche pour les grandes vis perforées
longitudinalement
Guía de brocas para los grandes tornillos
perforados longitudinalmente
Guida di trapano per grandi viti con
canale longitudinale

ZEPF®
INSTRUMENTS

33-8800-35 - 33-8809-45

33.32

KNOCHENCHIRURGIE, TRAUMATOLOGIE

BONE SURGERY, TRAUMATOLOGY

CHIRURGIE OSSEUSE, TRAUMATOLOGIE

CIRUGÍA ÓSEA, TRAUMATOLOGÍA

CHIRURGIA OSSEA, TRAUMATOLOGIA

Instrumente zur Osteosynthese
 Instruments for Osteosynthesis
 Instruments pour l'ostéosynthèse
 Instrumentos para osteosíntesis
 Strumenti per osteosintesi

**KNOCHENCHIRURGIE,
 TRAUMATOLOGIE**

**BONE SURGERY,
 TRAUMATOLOGY**

**CHIRURGIE OSSEUSE,
 TRAUMATOLOGIE**

**CIRUGÍA ÓSEA,
 TRAUMATOLOGÍA**

**CHIRURGIA OSSEA,
 TRAUMATOLOGIA**

Doppel- und Universal-Bohrbüchsen
 Double and Universal Drill Guides
 Guide-mèches doubles et universels
 Guías de brocas dobles y universales
 Guida-trapani doppi ed universali



34-1002-32

Bohrlehre für Plattenspanner für Bohrer 3,2 mm
 Drill sleeve for tension device for drill bit ø 3,2 mm
 Guide-mèche pour tenseur de plaques pour mèches ø 3,2 mm
 Guía de brocas para tensor de placas para broca ø 3,2 mm
 Guida trapano per tensori di placche per trapano ø 3,2 mm

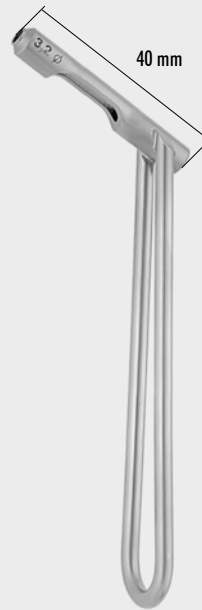

34-1005-40



34-1005-60

Bohrlehren für Rundlochplatten für Bohrer ø 3,2 mm
 Drill guides for round hole plates for drill bits ø 3,2 mm
 Guide-mèche pour les plaques à trous ronds pour des mèches ø 3,2 mm
 Guía de brocas para las placas con agujeros redondos para taladros ø 3,2 mm
 Guida trapano per le placche con fori rotondi per trapani ø 3,2 mm

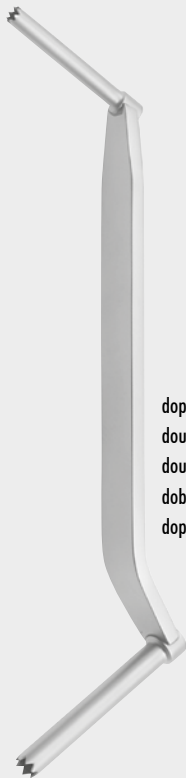

doppelt
 double
 double
 doble
 doppia

34-1010-45

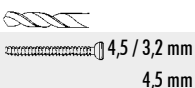

doppelt
 double
 double
 doble
 doppia

34-1012-65

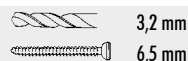

universal
 universal
 universal
 universale

34-1014-35

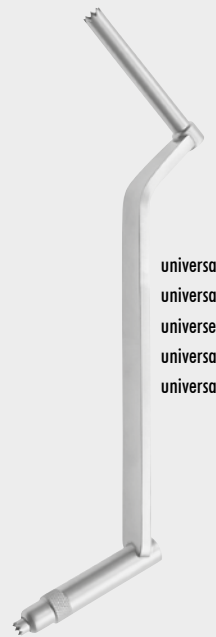

universal
 universal
 universal
 universale

34-1016-45

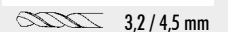

34-1002-32

34.2

Plattenspanner
 Compression Devices
 Compresseurs de plaques
 Compresores de placas
 Compressori per placche

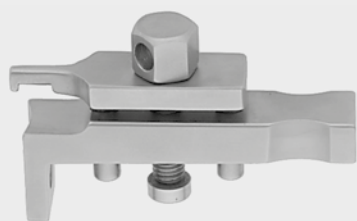

34-1100-08
 8 mm

Hub 8 mm
 Range 8 mm
 Course 8 mm
 Curso 8 mm
 Curso 8 mm



34-1101-16
 20 mm

Hub 20 mm
 Range 20 mm
 Course 20 mm
 Curso 20 mm
 Curso 20 mm

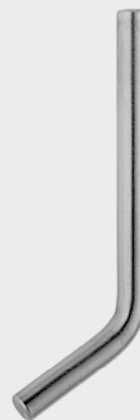

34-1101-99
 ø 4,5 mm / 12,0 cm

Stiftschlüssel
 Pin wrench
 Clé
 Llave
 Chiave

KNOCHENCHIRURGIE,
 TRAUMATOLOGIE

BONE SURGERY,
 TRAUMATOLOGY

CHIRURGIE OSSEUSE,
 TRAUMATOLOGIE

CIRUGÍA ÓSEA,
 TRAUMATOLOGÍA

CHIRURGIA OSSEA,
 TRAUMATOLOGIA



34-1105-11
 SW 11 mm



34-1106-11
 SW 11 mm

Schraubenschlüssel
 Socket and Combination Wrenches
 Clés à écrous
 Llaves para tuercas
 Chiavi per dadi



34-1106-11

34.3



Bohrbüchsen, Zapfenfüser
 Drill Guides, Reamer
 Guide-mèche, Fraise
 Guías de broca, Fresa
 Guida-tapano, Fresa

**KNOCHENCHIRURGIE,
 TRAUMATOLOGIE**

**BONE SURGERY,
 TRAUMATOLOGY**

**CHIRURGIE OSSEUSE,
 TRAUMATOLOGIE**

**CIRUGÍA ÓSEA,
 TRAUMATOLOGÍA**

**CHIRURGIA OSSEA,
 TRAUMATOLOGIA**

Instrumente für Winkelplatten
 Instruments for Angled Plates
 Instruments pour les plaques angulaires
 Instrumentos para placas angulares
 Strumenti per placche angolari



	2,0 mm	34-1205-20	neutr. / exc.
	2,7 mm	34-1205-27	neutr. / exc.
	3,5 mm	34-1205-35	neutr. / exc.
	4,5 mm	34-1207-45	neutr. / exc.



Hüfte - Hip-
 Hanche - Cadera -
 Anca

	4,5 mm	34-1209-60	60 mm
--	--------	------------	-------



Dreifach
 Triple
 Triplice

	3,2 mm	34-2100-13
--	--------	------------



AO 34-2102-02



34-2104-00



34-2302-13



34-2302-15



34-2304-20



34-2304-22



34-1205-20

34.4

* nicht kalibriert
not calibrated
pas calibré
no calibrado
non calibrato

Instrumente für Winkelplatten
Instruments for Angled Plates
Instruments pour les plaques angulaires
Instrumentos para placas angulares
Strumenti per placche angolari



34-2306-07

Für Kleinkinder
For infants
Pour les petits enfants
Para niños pequeños
Per piccoli bambini



34-2308-17

Für kleinwüchsige Erwachsene und Jugendliche
For small adults and adolescents
Pour les petits adultes et les adolescents
Para adultos pequeños y adolescentes
Per adulti piccoli ed adolescenti



34-2310-02

Für Jugendliche und Kinder
For adolescents and children
Pour adolescents et enfants
Para adolescentes y niños
Per adolescenti e bambini

**KNOCHENCHIRURGIE,
TRAUMATOLOGIE**

**BONE SURGERY,
TRAUMATOLOGY**

**CHIRURGIE OSSEUSE,
TRAUMATOLOGIE**

**CIRUGÍA ÓSEA,
TRAUMATOLOGÍA**

**CHIRURGIA OSSEA,
TRAUMATOLOGIA**



34-2313-01 *
90° / 50° / 40°



34-2313-02 *
80° / 70° / 30°



34-2313-03 *
100° / 60° / 20°

Dreieckzielplatten für Erwachsene
Triangular Positioning Plates Adult Size
Plaques de pose triangulaires pour adultes
Patrones triangulares para adultos
Placche per posizionare per adulti



34-2313-03

34.5

* nicht kalibriert
not calibrated
pas calibré
no calibrado
non calibrato

Dreieckzielplatten für Kinder
Triangular Positioning Plates Child Size
Plaques de pose triangulaires pour enfants
Patrones triangulares para niños
Placche triangolari per posizionare per bambini



34-2313-06 *
90° / 50° / 40°



34-2313-07 *
80° / 70° / 30°



34-2313-08 *
100° / 60° / 20°

Viereckzielplatten
Quadrangular Positioning Plates
Plaques de pose quadrangulaires
Patrones cuadrangulares
Placche quadrangolari per posizionare

**KNOCHENCHIRURGIE,
TRAUMATOLOGIE**

**BONE SURGERY,
TRAUMATOLOGY**

**CHIRURGIE OSSEUSE,
TRAUMATOLOGIE**

**CIRUGÍA ÓSEA,
TRAUMATOLOGÍA**

**CHIRURGIA OSSEA,
TRAUMATOLOGIA**



34-2313-10 *
110° / 90° / 90° / 70°

Für Erwachsene
Adult size
Pour adultes
Para adultos
Per adulti



34-2313-16 *
110° / 90° / 90° / 70°

Für Kinder
Child size
Pour enfants
Para niños
Per bambini



34-2313-20 *

Kondylenzielgerät - Condylar plate guide - Viseur pour le positionnement de plaques condyliennes - Visor para posicionar placas condíleas - Visore per posizionare placche condiloidee

Bohrziellehren verstellbar für dynamische Hüftschrauben
Drill Guides Adjustable for Dynamic Hip Screws
Guides de mèches réglables pour les vis fémorales dynamiques
Guías de brocas ajustables para tornillos femorales dinámicos
Guida-trapani regolabili per viti femorali dinamiche



34-3307-00 *
135° / 140° / 145° / 150°

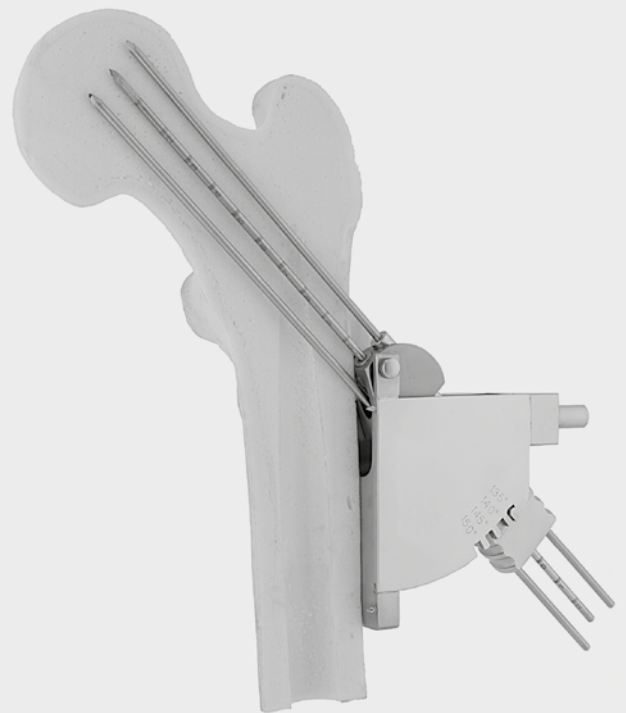

34-3307-03 *
135° / 140° / 145° / 150°



Führungsstift kalibriert mit Gewinde
 Guide pin threaded and calibrated
 Broche-guide calibré avec filet
 Guía calibrada con rosca
 Guida calibrata con filetto

34-3308-00
 L = 230 mm ø 2,5 mm



Bohrerführung
 Drill Guide
 Guide-mèche
 Guía taladro
 Guida trapano

135° 34-3308-01
 140° 34-3308-02
 145° 34-3308-03
 150° 34-3308-04



Schraubenmessgerät
 Measuring Gauge
 Mesureur des vis
 Medidor de los tornillos
 Misuratore delle viti

34-3308-05



Schraubenschlüssel
 Wrench
 Clé
 Llave
 Chiave

34-3308-06

* nicht kalibriert
 not calibrated
 pas calibré
 no calibrado
 non calibrato

Instrumente für dynamische Hüftschrauben
 Instruments for Dynamic Hip Screws
 Instruments pour vis fémorales dynamiques
 Instrumentos para tornillos dinámicos femorales
 Strumenti per viti dinamiche femorali

KNOCHENCHIRURGIE,
 TRAUMATOLOGIE

BONE SURGERY,
 TRAUMATOLOGY

CHIRURGIE OSSEUSE,
 TRAUMATOLOGIE

CIRUGÍA ÓSEA,
 TRAUMATOLOGÍA

CHIRURGIA OSSEA,
 TRAUMATOLOGIA



Handgriff
 Handle
 Manche
 Mango
 Manico

34-3308-08



Einschläger
 Impactor
 Impacteur
 Impactor
 Conficcatore

34-3308-14



Gewindeschneider
 Tap
 Taraud
 Macho
 Maschiatore

34-3308-17*



Führungshülsen
 Guide Sleeves
 Gaines conductrices
 Piezas de conducción
 Pezzi per condurre

Instrumente für dynamische Hüftschrauben
 Instruments for Dynamic Hip Screws
 Instruments pour vis fémorales dynamiques
 Instrumentos para tornillos dinámicos femorales
 Strumenti per viti dinamiche femorali



34-3308-18

kurz, für
 Gewindeschneider
 short, for tapping
 courte, pour les tarauds
 corta, para machos
 corto, per maschiatori



34-3308-19

lang, zum Einsetzen der
 Hüftschrauben
 long, for inserting the
 hip screws
 longue, pour l'introduction
 des vis dynamiques
 larga, para la introducción
 de los tornillos dinámicos
 lunga, per introdurre le
 viti dinamiche



34-3308-20

Führungsschaft
 Guide shaft
 Tige conductrice
 Asta conductora
 Asta conduttrice



34-3308-21

Führungsschaft für
 Kupplungsschraube
 Guide shaft for coupling
 screw
 Guide pour l'introduction
 des vis connectrices
 Guía para la introducción
 de los tornillos de acople
 Guida per introdurre le
 viti connetrici

**KNOCHENCHIRURGIE,
 TRAUMATOLOGIE**

**BONE SURGERY,
 TRAUMATOLOGY**

**CHIRURGIE OSSEUSE,
 TRAUMATOLOGIE**

**CIRUGÍA ÓSEA,
 TRAUMATOLOGÍA**

**CHIRURGIA OSSEA,
 TRAUMATOLOGIA**



34-3308-22

Kupplungsschraube
 Coupling Screw
 Vis connectrice
 Tornillo de acople
 Vite connetrice



34-3308-42

Bohrerführung
 Drill Guide
 Guide-mèche
 Guía de brocas
 Guida di trapano



34-3308-93

Langer Fräser
 Long reamer
 Fraise longue
 Fresa larga
 Fresa lunga

Dreistufen-Bohrer
 Triple Reamers
 Fraises triples
 Fresas triples
 Frese triplici



34-3308-95

Kurzer Fräser
 Short reamer
 Fraise courte
 Fresa corta
 Fresa corta



34-3308-18

34.8



Markraumborher flexibel mit HUDSON Ansatz
 Intramedullary reamers with HUDSON drive connection
 Mèches centromédullaires avec connecteurs HUDSON
 Taladros flexibles intramedulares con adaptadores HUDSON
 Trapani flessibili centromidollari con raccordi HUDSON

ø mm		ø mm	
5,5	34-3400-55	12,0	34-3401-20
6,0	34-3400-60	12,5	34-3401-25
6,5	34-3400-65	13,0	34-3401-30
7,0	34-3400-70	13,5	34-3401-35
7,5	34-3400-75	14,0	34-3401-40
8,0	34-3400-80	14,5	34-3401-45
8,5	34-3400-85	15,0	34-3401-50
9,0	34-3400-90	15,5	34-3401-55
9,5	34-3400-95	16,0	34-3401-60
10,0	34-3401-00	16,5	34-3401-65
10,5	34-3401-05	17,0	34-3401-70
11,0	34-3401-10	17,5	34-3401-75
11,5	34-3401-15	18,0	34-3401-80

34-3400-55 - 34-3401-80
L = 480 mm



Flexible Markraum-Bohrer, Ansatz Aesculap DIN 58809
 Flexible Intramedullary Reamers, adaptor Aesculap DIN 58809
 Mèches flexibles centromédullaires, adaptateurs Aesculap DIN 58809
 Brocas flexibles intramedulares, adaptadores Aesculap DIN 58809
 Trapani flessibili centromidollari, raccordi Aesculap DIN 58809

ø mm		ø mm	
5,5	34-3402-55	12,0	34-3403-20
6,0	34-3402-60	12,5	34-3403-25
6,5	34-3402-65	13,0	34-3403-30
7,0	34-3402-70	13,5	34-3403-35
7,5	34-3402-75	14,0	34-3403-40
8,0	34-3402-80	14,5	34-3403-45
8,5	34-3402-85	15,0	34-3403-50
9,0	34-3402-90	15,5	34-3403-55
9,5	34-3402-95	16,0	34-3403-60
10,0	34-3403-00	16,5	34-3403-65
10,5	34-3403-05	17,0	34-3403-70
11,0	34-3403-10	17,5	34-3403-75
11,5	34-3403-15	18,0	34-3403-80

34-3402-55 - 34-3403-80
L = 480 mm

Instrumente zur Markraumnagelung
 Instruments for Intramedullary Nailing
 Instruments pour l'enclouage centromédullaire
 Instrumentos para el enclavamiento intramedular
 Strumenti per il inchiodamento centro-midollare

**KNOCHENCHIRURGIE,
TRAUMATOLOGIE**

**BONE SURGERY,
TRAUMATOLOGY**

**CHIRURGIE OSSEUSE,
TRAUMATOLOGIE**

**CIRUGÍA ÓSEA,
TRAUMATOLOGÍA**

**CHIRURGIA OSSEA,
TRAUMATOLOGIA**



Führungsstäbe für Markraumborher
 Guide Rods for intramedullary reamers
 Guides pour les perforateurs centromédullaires
 Barras-guía para perforadores intramedulares
 Aste di guida per perforatori centro-midollari

34-3408-02

ø 3,0 mm L = 900 mm



34-3408-03

ø 4,0 mm L = 900 mm



Markraumborher
 Intramedullary Reamers
 Perforateurs centromédullaires
 Perforadores intramedulares
 Perforatori centro-midollari

ø mm	
6,0	34-3414-06
7,0	34-3414-07
8,0	34-3414-08
9,0	34-3414-09
10,0	34-3414-10
11,0	34-3414-11
12,0	34-3414-12
13,0	34-3414-13
14,0	34-3414-14
15,0	34-3414-15
16,0	34-3414-16
17,0	34-3414-17
18,0	34-3414-18
19,0	34-3414-19
20,0	34-3414-20

34-3414-06 - 34-3414-20

ZEPF®
INSTRUMENTS

34-3414-20

34.9

Instrumente für flexible Markraumnägel
 Instruments for Flexible Intramedullary Nails
 Instruments pour les clous centromédullaires flexibles
 Instrumentos para los clavos intramedulares flexibles
 Strumenti per chiodi centromidollari flessibili

**KNOCHENCHIRURGIE,
 TRAUMATOLOGIE**

**BONE SURGERY,
 TRAUMATOLOGY**

**CHIRURGIE OSSEUSE,
 TRAUMATOLOGIE**

**CIRUGÍA ÓSEA,
 TRAUMATOLOGÍA**

**CHIRURGIA OSSEA,
 TRAUMATOLOGIA**

Einführer
 Inserter
 Introducteur
 Introducitor
 Introduuttore



34-3604-00

Einschläger
 Impactor
 Chasse-clou
 Empujador
 Conficatore



34-3605-00

Biegehebel
 Bender
 Plieur
 Plegador
 Piegatore



34-3608-00

Ausschläger
 Extractor
 Extracteur
 Extractor
 Cavachiodi



34-3614-00

Ein- und Ausschläger
 Impactor - Extractor
 Chasse-clou et extracteur
 Empujador y extractor
 Conficatore e cavachiodi



34-3610-00



2,5 mm

Vorbohrer-Nagelstarter
Nail Starter and Cortex Broach
Fraise et chasse-clous
Iniciador para clavos y empujador
Alesatore corticale e strumento per conficcare

cm RITCHEY
20,0 34-3620-20



Einschläger-Ausschläger
Impactor-Extractor
Chasse-clous et extracteur
Empujador y extractor
Strumento per conficcare e cavachiodi

cm LLOYD
21,0 34-3621-21



Vorschläger
Nail Driver
Chasse-clous
Conductor
Conficcatore

cm SVEN JOHANSSON
16,0 34-3622-16

Instrumente für Drei-Lamellen-Nägel
Instruments for Three-Flange-Nails
Instruments pour les clous à trois ailettes
Instrumentos para clavos con tres aletas
Strumenti per chiodi con tre alette

KNOCHENCHIRURGIE,
TRAUMATOLOGIE

BONE SURGERY,
TRAUMATOLOGY

CHIRURGIE OSSEUSE,
TRAUMATOLOGIE

CIRUGÍA ÓSEA,
TRAUMATOLOGÍA

CHIRURGIA OSSEA,
TRAUMATOLOGIA



Nagelstarter
Nail Starter
Chasse-clous
Empujador
Strumento per conficcare

SMITH PETERSEN
34-3630-00



Einschläger-Ausschläger
Impactor-Extractor
Chasse-clous et extracteur
Empujador y extractor
Conficcatore e cavachiodi

JEWETT
34-3632-00

Instrumente für Knochennägel
 Instruments for Bone Nails
 Instruments pour les clous à os
 Instrumentos para los clavos para huesos
 Strumenti per chiodi per ossa

**KNOCHENCHIRURGIE,
 TRAUMATOLOGIE**

**BONE SURGERY,
 TRAUMATOLOGY**

**CHIRURGIE OSSEUSE,
 TRAUMATOLOGIE**

**CIRUGÍA ÓSEA,
 TRAUMATOLOGÍA**

**CHIRURGIA OSSEA,
 TRAUMATOLOGIA**

Instrumente für Knochenklammern
 Instruments for Bone Staples
 Instruments pour les agrafes à os
 Instrumentos para agrafes para huesos
 Strumenti per agrafe per ossa



34-3652-15

34.12

Einschlaginstrument
 Impactor
 Chasse-clous
 Empujador
 Strumento da conficcare



cm PALMER
 15,0 34-3652-15

Nachschlaginstrument
 Final Impactor
 Impacteur final
 Empujador final
 Strumento da conficcare finale

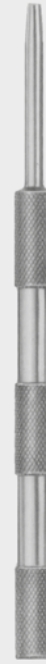

cm PALMER
 17,0 34-3654-17



Auszieher
 Extractor
 Extracteur
 Extractor
 Estrattore

34-3702-00



Einschläger
 Driver
 Chasse-agrafes
 Empujador
 Strumento per conficcare

34-3704-00



Einsetzer
 Introducer
 Introducteur
 Introducitor
 Introduttore

34-3706-00



Einschläger
 Driver
 Chasse-agrafes
 Empujador
 Strumento per conficcare

34-3708-00

Einschläger
 Driver
 Chasse-agrafes
 Empujador
 Strumento per conficcare



34-3710-01
 34-3710-02

Drahtspanner
Wire Tighteners
Tenseurs de fils
Tensores de alambre
Tensori per filo



34-3810-01



34-3810-02

Biegeisen für Bohrdrähte
Bending Iron for wire drills
Fer à plier les perforateurs filiformes
Instrumento para doblar perforadores filiformes
Strumento per piegare KIRSCHNER aghi



34-3820-00

Instrumente für Draht
Wire Instruments
Instruments pour le fil
Instrumentos para alambre
Strumenti per fili

KNOCHENCHIRURGIE,
TRAUMATOLOGIE

BONE SURGERY,
TRAUMATOLOGY

CHIRURGIE OSSEUSE,
TRAUMATOLOGIE

CIRUGÍA ÓSEA,
TRAUMATOLOGÍA

CHIRURGIA OSSEA,
TRAUMATOLOGIA



34-3850-01



34-3850-02



34-3850-03



34-3850-04



34-3850-05



34-3850-06



34-3850-10

Schraubendreher mit auswechselbaren Klingen
Screwdriver with Interchangeable Blades
Tourne-vis avec les pointes interchangeables
Destornillador con hojas intercambiables
Cacciaviti con punte intercambiabili

ZEPF®
INSTRUMENTS

34-3850-10

34.13