



Plastic Surgery

HERMANN
MEDIZINTECHNIK

Precision
for beauty



Precision for beauty





Since more than 50 years:

Quality and Safety

Know How and Innovation
Technology and Precision
Service and Flexibility

Quality Management:

Certified according to: ISO 13485;
Annex II, section 3 of the directive
93/42/EEC

Our Products:

Instruments for MIS (Laparoscopy,
Hysteroscopy, Arthroscopy, Urology)

Endoscopy units

Electrosurgery and accessories

Plastic surgery

Titanium-implant-systems for
maxillo-facial as well as hand-
and radius surgery, mandibular
reconstruction

Scissors and micro-scissors, also with
TC-inserts or "super cut"

Instruments for general surgery

Table of contents

Page

Bone Cutting Forceps	81
Breast Retractors	52,53
Chisels	60
Curettes	63
Dissectors	71
Elevators	65-67
Forceps	74-77
Forceps / Thumb	28-35
Hooks	57,68,69
Knives	78,79
Lead Hand	51
Lipo Suction Cannulas	85-87
Mallets	61
Markers	72,73
Measuring	70
Micro Needle Holders	24-27
Micro Scissors	17
Micro Forceps	35
Morselizers	62
Mouth Gag	51
Nasal Rasps	36-39
Nasal Speculas	64
Needle Holders	18-27
Osteotomes	58-60
Retractors	40-50
Rongeurs	80
Ruler	82
Saws	63
Scalpel Handles	57, 79
Scissors	4-17
Self Retaining Retractors	43
Septum Forceps	63
Shaper / Dissectors	54-57
Suction Elevator	57,65
Suction Tubes	82
Wire Brush	39
Wire Pliers	83,84

We reserve the right
to make alterations.

Scissors

Gorney

- H108-21518** 18.0 cm, curved, serrated, TC
- H108-21420** 20.0 cm, straight, serrated, TC
- H108-21520** 20.0 cm, curved, serrated, TC
- H108-21523** 23.0 cm, curved, serrated, TC



Gorney

- H108-21220** 20.0 cm, straight, serrated
- H108-21320** 20.0 cm, curved, serrated



Freeman Gorney

- H108-21620** 20.0 cm, straight, TC
- H108-21720** 20.0 cm, curved, TC



Freeman

- H108-21918** 18.0 cm, straight, TC
- H108-22018** 18.0 cm, curved, TC



Aston-Face

- H108-24516** 17.0 cm, curved
- H108-24520** 20.0 cm, curved



Rees

- H108-22417** 17.0 cm, straight, serrated, TC
- H108-22517** 17.0 cm, curved, serrated, TC
- H108-22419** 20.0 cm, straight, serrated, TC
- H108-22519** 20.0 cm, curved, serrated, TC



Kaye

- H108-23315** 15.0 cm, curved, serrated, TC
- H108-23323** 23.0 cm, curved, serrated, TC



Kaye

- H108-23312** 11.5 cm, curved, serrated, TC



Scissors

H108-21818 Freeman (Kaye) 18.0 cm, curved, serrated, TC
H108-21820 20.0 cm, curved, serrated, TC



H108-24018 Davis 18.0 cm, curved, serrated, sharp/sharp, TC



H108-24816 Castanares 16.5 cm, straight, TC



H108-82313 Goldman Fox 13.0 cm, curved, serrated, TC



Par Style

very delicate

H108-20911

11.5 cm, curved, TC

H108-20914

14.5 cm, curved, TC

for serrated blades please add "WS"



Stevens Tenotomy

H108-36051

11.5 cm, straight, TC

H108-36151

11.5 cm, curved, TC



Stevens Tenotomy

H108-36011

11.0 cm, straight, sharp/sharp

H108-36111

11.0 cm, curved, sharp/sharp

H108-36211

11.0 cm, straight, blunt/blunt

H108-36311

11.0 cm, curved, blunt/blunt



Devine

fine dissecting scissors
with sharp tips,

H108-21011

11.0 cm, curved, TC



Scissors

Kilner

- H108-31212** 12.0 cm, straight, TC
- H108-31412** 12.0 cm, curved, TC
- H-5851BLHM** 12.0 cm, curved
1 blade TC
1 blade serrated



Strabismus

- H108-37411** 11.0 cm, straight, TC
 - H108-37511** 11.0 cm, curved, TC
 - H107-37411** 11.0 cm, straight, supercut
 - H107-37511** 11.0 cm, curved, supercut
- for serrated blades please add "WS"



Iris

- H108-34211** 11.5 cm, round, straight, sharp/sharp
 - H108-34311** 11.5 cm, round, curved, sharp/sharp
 - H108-34251** 11.5 cm, round, straight, sharp/sharp, TC
 - H108-34351** 11.5 cm, round, curved, sharp/sharp, TC
- for serrated blades please add "WS"



Iris

- H108-34011** 11.5 cm, square, straight, sharp/sharp
 - H108-34111** 11.5 cm, square, curved, sharp/sharp
 - H108-34411** 11.5 cm, square, straight, sharp/sharp, TC
 - H108-34511** 11.5 cm, square, curved, sharp/sharp, TC
- for serrated blades please add "WS"



Joseph

- H108-30414** 14.0 cm, straight, sharp/sharp
- H108-30514** 14.0 cm, curved, sharp/sharp
- H108-30454** 14.0 cm, straight, sharp/sharp, TC
- H108-30554** 14.0 cm, curved, sharp/sharp, TC



Locklin

- H108-53916** 16.0 cm, straight, angled, sharp/sharp, TC



Shea

- H108-30612** 12.0 cm, sharp, fine, curved



Scissors

H108-40118 Heymann
18.0 cm, angled to side



H108-39518 Knight
18.0 cm, angled to side, serrated,
delicate blades, TC



H108-35010 Wilmer Converse
10.5 cm, angled up



H108-40213

Fomon
13.5 cm, lower lateral scissor,
strongly curved



H108-40354

Fomon
14.5 cm, angled, TC



H108-40716

Cottle
17.0 cm, angled, TC



Scissors

Caplan Septum

H146-26120 22.0 cm, one blade serrated,
double action, straight

H146-26122 22.0 cm, one blade serrated,
double action, curved



Metzenbaum blunt/blunt

H108-28415 14.5 cm, straight, TC

H108-28515 14.5 cm, curved, TC

H108-28418 18.0 cm, straight, TC

H108-28518 18.0 cm, curved, TC

H108-28420 20.5 cm, straight, TC

H108-28520 20.5 cm, curved, TC

H108-28423 23.0 cm, straight, TC

H108-28523 23.0 cm, curved, TC

H108-28428 28.0 cm, straight, TC

H108-28528 28.0 cm, curved, TC

for serrated blades please add "WS"



Metzenbaum, blunt/blunt

H107-28015 14.5 cm, straight, supercut

H107-28115 14.5 cm, curved, supercut

H107-28018 18.0 cm, straight, supercut

H107-28118 18.0 cm, curved, supercut

H107-28023 23.0 cm, straight, supercut

H107-28123 23.0 cm, curved, supercut



Metzenbaum Fino blunt/blunt

- H108-28615** 14.5 cm, straight, TC
- H108-28715** 14.5 cm, curved, TC
- H108-28618** 18.0 cm, straight, TC
- H108-28718** 18.0 cm, curved, TC
- H108-28620** 20.0 cm, straight, TC
- H108-28720** 20.0 cm, curved, TC
- H108-28623** 23.0 cm, straight, TC
- H108-28723** 23.0 cm, curved, TC
- H108-28628** 28.0 cm, straight, TC
- H108-28728** 28.0 cm, curved, TC

for serrated blades please add "WS"



Metzenbaum sharp/sharp

- H108-27415** 14.5 cm, straight, TC
- H108-27515** 14.5 cm, curved, TC
- H108-27418** 18.0 cm, straight, TC
- H108-27518** 18.0 cm, curved, TC
- H108-27423** 23.0 cm, straight, TC
- H108-27523** 23.0 cm, curved, TC

for serrated blades please add "WS"



Mayo-Stille

- H108-17415** 15.0 cm, straight, TC
- H108-17515** 15.0 cm, curved, TC
- H108-17417** 17.0 cm, straight, TC
- H108-17517** 17.0 cm, curved, TC

for serrated blades please add "WS"



Scissors

H107-17017 Mayo-Stille
H107-17117 17.0 cm, straight, supercut
17.0 cm, curved, supercut



H108-19421 Mayo-Lexer
H108-19521 21.0 cm, straight, TC
21.0 cm, curved, TC



H108-11214 Operating sharp/blunt
H108-11314 14.5 cm, straight, round, TC
14.5 cm, curved, round, TC



H108-12214 Operating sharp/sharp
14.5 cm, straight, round, TC
H108-12314 14.5 cm, curved, round, TC



H108-10614 Operating blunt/blunt
14.5 cm, straight, round, TC
H108-10714 14.5 cm, curved, round, TC



H108-83512 Universal Wire Scissors
12.0 cm, serrated, TC



H108-36509 Stevens Tenotomy Scissors
9.5 cm, curved, sharp/sharp, ribbon type
H108-36512 12.0 cm, curved, sharp/sharp, ribbon type



Scissors

Iris

- H108-32209** 9.5 cm, straight, sharp/sharp, ribbon type
- H108-32309** 9.5 cm, curved, sharp/sharp, ribbon type
- H108-32610** 10.5 cm, straight, sharp/sharp, ribbon type
- H108-32710** 10.5 cm, curved, sharp/sharp, ribbon type

Littler

- H108-20512** 12.0 cm, curved, tips with eye for suture
- H108-20514** 14.0 cm, curved, tips with eye for suture

Spencer

- H108-80209** 9.0 cm, straight, ligature scissor

Knowles Bandage

- H108-93114** 14.0 cm, angled, serrated



Lister Bandage

H108-90114

14.0 cm, angled

H108-90118

18.0 cm, angled



Freeman Kaye

H108-21617

17.0 cm, curved



Micro Scissors

spring scissors with round handle, blade 14 mm

H109-20615

15.0 cm, straight

H109-20815

15.0 cm, straight, blades serrated

H109-20715

15.0 cm, curved

H109-20915

15.0 cm, curved, blades serrated

H109-20618

18.0 cm, straight

H109-20818

18.0 cm, straight, blades serrated

H109-20718

18.0 cm, curved

H109-20918

18.0 cm, curved, blades serrated



Needle Holders

H124-12811 Webster 11.5 cm, smooth
H124-12913 13.0 cm, smooth, TC



H124-13413 Halsey 13.0 cm, smooth, TC
H124-14413 13.0 cm, cross serrated, TC



H124-14011 Par 11.5 cm, cross serrated, TC
H124-14013 13.0 cm, cross serrated, TC



H124-11012 Derf 12.0 cm, serrated
H124-11412 12.0 cm, cross serrated, TC



H124-14713 Neivert 13.0 cm, cross serrated, TC



H124-21815 Swedish 15.5 cm, cross serrated, TC

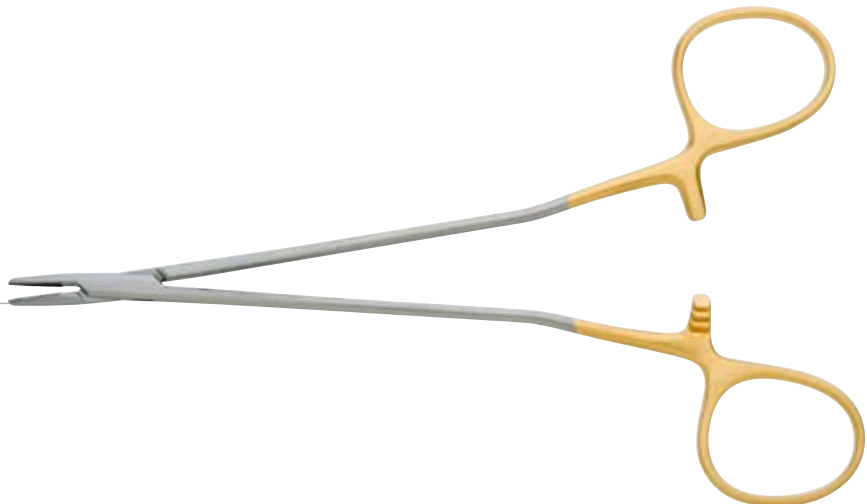

Needle Holders

Ryder

- H124-22413** 13.0 cm, cross serrated, TC
- H124-22415** 15.0 cm, cross serrated, TC
- H124-22418** 18.0 cm, cross serrated, TC



Micro Ryder

- H124-22613** 13.0 cm, cross serrated, TC
- H124-22615** 15.0 cm, cross serrated, TC
- H124-22618** 18.0 cm, cross serrated, TC



Euphrate-Pasque extremely delicate

- H124-23814** 14.0 cm, cross serrated, TC
- H124-23815** 15.0 cm, cross serrated, TC
- H124-23818** 18.0 cm, cross serrated, TC
- H124-23820** 20.0 cm, cross serrated, TC

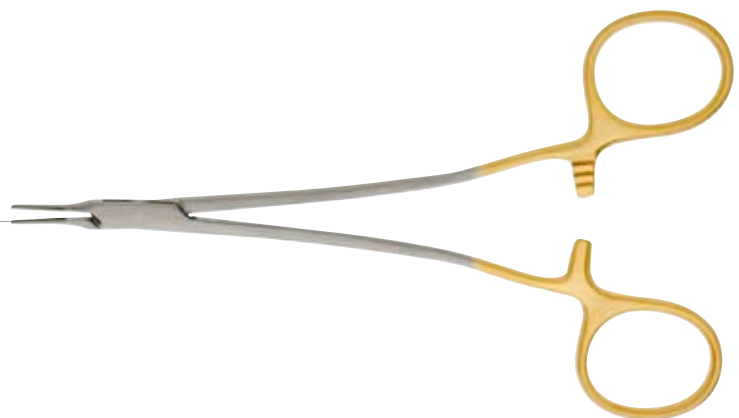

Micro-Vascular

- H124-23415** 15.0 cm, cross serrated, TC
- H124-23418** 18.0 cm, cross serrated, TC

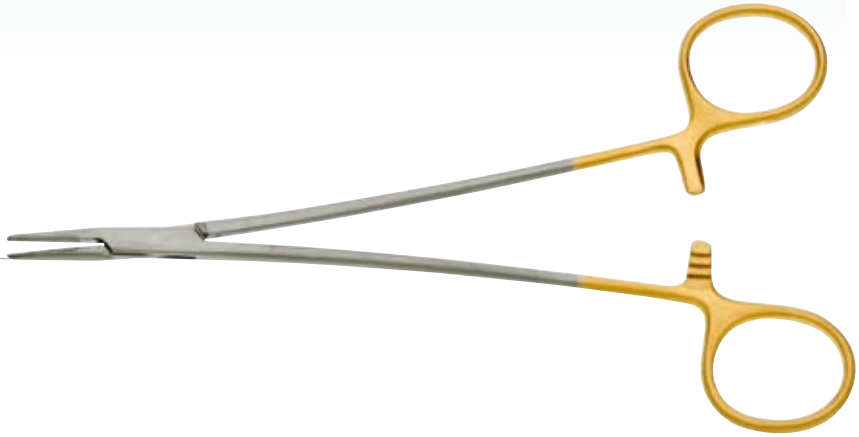

Crile-Wood

- H124-16215** 15.0 cm, smooth, TC
- H124-16415** 15.0 cm, cross serrated, TC
- H124-16418** 18.0 cm, cross serrated, TC
- H124-16420** 20.0 cm, cross serrated, TC
- H124-16423** 23.0 cm, cross serrated, TC



Lemmon

- H124-24814** 14.0 cm, cross serrated, TC
- H124-24817** 17.0 cm, cross serrated, TC
- H124-24819** 19.0 cm, cross serrated, TC

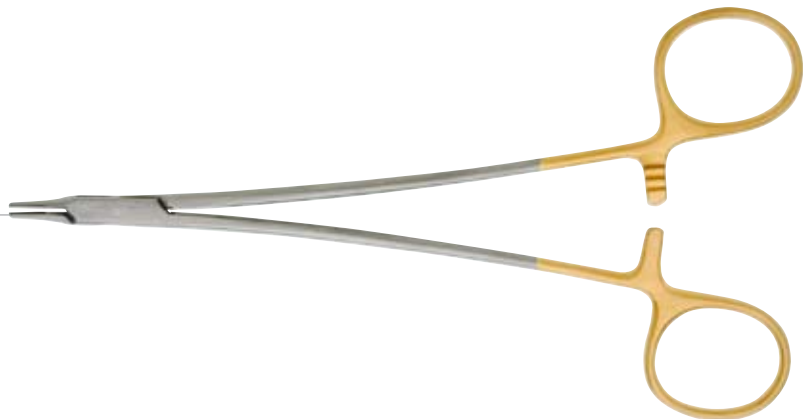

Needle Holders

Baumgartner

- H124-15412 12.5 cm, cross serrated, TC
- H124-15414 14.0 cm, cross serrated, TC



Mayo Hegar

- H124-18414 14.0 cm, cross serrated, TC
- H124-18416 16.0 cm, cross serrated, TC
- H124-18418 18.0 cm, cross serrated, TC
- H124-18420 20.0 cm, cross serrated, TC



Wire Twister

- H133-60011 13.0 cm, round jaw, cross serrated, TC
- H133-60001 16.0 cm, blunt jaw, cross serrated, TC
- H133-60012 18.0 cm, round jaw, cross serrated, TC
- H133-60002 18.0 cm, blunt jaw, cross serrated, TC

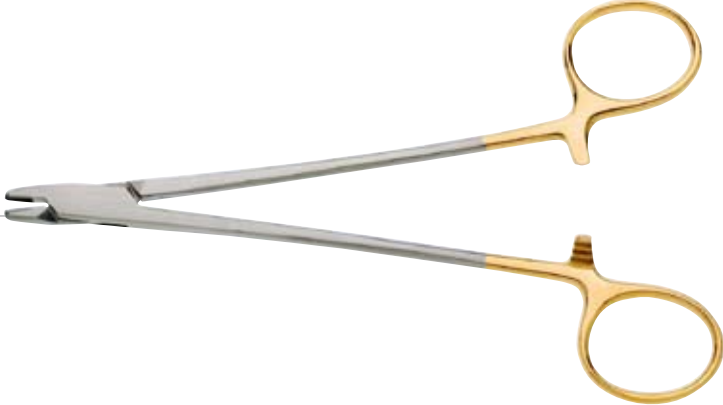

Corwin Wire Twister

- H133-53901** 16.0 cm, long round jaw, cross serrated, TC
- H133-53902** 16.0 cm, blunt jaw, cross serrated, TC
- H133-53903** 16.0 cm, round jaw, cross serrated, TC



Olsen Hegar

needleholder/scissors combination

- H124-41414** 14.0 cm, cross serrated, TC
- H124-41418** 18.0 cm, cross serrated, TC



Gillies

needleholder/scissors combination

- H124-43416** 16.0 cm, cross serrated, curved, TC



Needle Holders

Barraquer Micro

with round handle, without lock, tip 0.8 × 1.2 mm

H124-64014 14.0 cm,
straight, diamond dusted

H124-64114 14.0 cm,
curved, diamond dusted

H124-64015 15.0 cm,
straight, diamond dusted

H124-64115 15.0 cm,
curved, diamond dusted

H124-64018 18.0 cm,
straight, diamond dusted

H124-64118 18.0 cm,
curved, diamond dusted



Barraquer Micro

with round handle, with lock, tip 0.8 × 1.2 mm

H124-64214 14.0 cm,
straight, diamond dusted

H124-64314 14.0 cm,
curved, diamond dusted

H124-64215 15.0 cm,
straight, diamond dusted

H124-64315 15.0 cm,
curved, diamond dusted

H124-64218 18.0 cm,
straight, diamond dusted

H124-64318 18.0 cm,
curved, diamond dusted



Barraquer Delicate

with round handle, without lock, tip 1.2 × 1.8 mm

- H124-63414** 14.0 cm,
cross serrated, straight, TC
- H124-63514** 14.0 cm,
cross serrated, curved, TC
- H124-63415** 15.0 cm,
cross serrated, straight, TC
- H124-63515** 15.0 cm,
cross serrated, curved, TC
- H124-63418** 18.0 cm,
cross serrated, straight, TC
- H124-63518** 18.0 cm,
cross serrated, curved, TC



Barraquer Micro

with round handle, without lock, tip 0.8 × 1.2 mm

- H124-63614** 14.0 cm,
cross serrated, straight, TC
- H124-63714** 14.0 cm,
cross serrated, curved, TC
- H124-63615** 15.0 cm,
cross serrated, straight, TC
- H124-63715** 15.0 cm,
cross serrated, curved, TC
- H124-63618** 18.0 cm,
cross serrated, straight, TC
- H124-63718** 18.0 cm,
cross serrated, curved, TC



Needle Holders

Barraquer Delicate

with round handle, with lock, tip 1.2 × 1.8 mm

- H124-66714** 14.0 cm,
cross serrated, straight, TC
- H124-66614** 14.0 cm,
cross serrated, curved, TC
- H124-66715** 15.0 cm,
cross serrated, straight, TC
- H124-66615** 15.0 cm,
cross serrated, curved, TC
- H124-66718** 18.0 cm,
cross serrated, straight, TC
- H124-66618** 18.0 cm,
cross serrated, curved, TC



Barraquer Micro

with round handle, with lock, tip 0.8 × 1.2 mm

- H124-66814** 14.0 cm, cross serrated, straight, TC
- H124-66914** 14.0 cm, cross serrated, curved, TC
- H124-66815** 15.0 cm, cross serrated, straight, TC
- H124-66915** 15.0 cm, cross serrated, curved, TC
- H124-66818** 18.0 cm, cross serrated, straight, TC
- H124-66918** 18.0 cm, cross serrated, curved, TC



Castroviejo

with flat handle, with lock

- H124-67813** 14.0 cm, smooth, straight, TC
- H124-67814** 14.0 cm, cross serrated, straight, TC
- H124-67513** 14.0 cm, smooth, curved, TC
- H124-67514** 14.0 cm, cross serrated, curved, TC
- H124-67817** 18.0 cm, smooth, straight, TC
- H124-67819** 18.0 cm, cross serrated, straight, TC
- H124-67517** 18.0 cm, smooth, curved, TC
- H124-67518** 18.0 cm, cross serrated, curved, TC



Castroviejo

with flat handle, without lock

- H124-69614** 14.0 cm, straight, diamond dusted
- H124-69714** 14.0 cm, curved, diamond dusted
- H124-69618** 18.0 cm, straight, diamond dusted
- H124-69718** 18.0 cm, curved, diamond dusted



Castroviejo

with flat handle, with lock

- H124-69814** 14.0 cm,
straight, diamond dusted
- H124-69914** 14.0 cm,
curved, diamond dusted
- H124-69818** 18.0 cm,
straight, diamond dusted
- H124-69918** 18.0 cm,
curved, diamond dusted



Castroviejo Ryder

with flat handle, with lock

- H124-70214** 14.0 cm, cross serrated,
straight, TC
- H124-70218** 18.0 cm, cross serrated,
straight, TC



Barraquer

with round handle, with inserted jaws 0.75mm

- H124-65712** 12.0 cm, straight, without lock, smooth
- H124-65912** 12.0 cm, curved, without lock, smooth



Forceps / Thumb

H110-17412	Adson 12.0 cm, cross serrated, TC	
H110-17415	15.0 cm, cross serrated, TC	
H110-20412	Adson 12.0 cm, serrated, Titanium	
H110-17012	Adson 12.0 cm, serrated	
H110-17612	12.0 cm, serrated, Micro	
H110-17912	Adson Dressing 12.0 cm, cross serrated	
H110-17512	Adson 12.0 cm, cross serrated, 1x2 teeth, TC	
H110-17515	15.0 cm, cross serrated, 1x2 teeth, TC	
H110-20512	Adson 12.0 cm, smooth, 1x2 teeth, Titanium	
H110-18012	Adson Tissue 12.0 cm, smooth, 1x2 teeth	

H110-18512 **Adson Tubiana**
12.0 cm, 1x2 teeth, with platform 1 mm

A pair of Adson Tubiana forceps with a 12.0 cm length, 1x2 teeth, and a 1 mm platform. The jaws are finely serrated, and the handle is smooth and tapered.

H110-18802 **Brown-Adson**
12.0 cm, cross serrated, Brown teeth, TC
H110-18805 15.0 cm, cross serrated, Brown teeth, TC

A pair of Brown-Adson forceps. The 12.0 cm version has cross serrated jaws and brown teeth. The 15.0 cm version also has cross serrated jaws and brown teeth. The handle is smooth and tapered.

H110-18812 **Brown-Adson**
12.0 cm, Brown teeth

A pair of Brown-Adson forceps with a 12.0 cm length and brown teeth. The jaws are finely serrated, and the handle is smooth and tapered.

H110-17312 **Adson Micro**
12.0 cm, cross serrated, 1x2 teeth, TC
H110-17315 15.0 cm, cross serrated, 1x2 teeth, TC

A pair of Adson Micro forceps. The 12.0 cm version has cross serrated jaws and 1x2 teeth. The 15.0 cm version also has cross serrated jaws and 1x2 teeth. The handle is smooth and tapered.

H110-17452 **Par**
12.0 cm, cross serrated, TC

A pair of Par forceps with a 12.0 cm length, cross serrated jaws, and TC. The handle is smooth and tapered.

H110-16912 **Adson Delicate**
12.0 cm, smooth, TC
H110-17455 15.0 cm, cross serrated, TC

A pair of Adson Delicate forceps. The 12.0 cm version has smooth jaws and TC. The 15.0 cm version has cross serrated jaws and TC. The handle is smooth and tapered.

H110-18612D **Gorney-Adson**
12.0 cm, 1x2 teeth,
with platform, diamond dusted

A pair of Gorney-Adson forceps with a 12.0 cm length, 1x2 teeth, a platform, and diamond dusted jaws. The handle is smooth and tapered.

Forceps / Thumb

Castroviejo

- H143-14915** 10,5 cm, 1.5 mm tip, 1x2 teeth, with platform
- H143-14903** 10,5 cm, 3 mm tip, 1x2 teeth, with platform
- H143-14905** 10,5 cm, 5 mm tip, 1x2 teeth, with platform
- H143-14909** 10,5 cm, 9 mm tip, 1x2 teeth, with platform



Castroviejo-Brown

- H110-18851** 11.0 cm, brown teeth



Graefe Iris

- H142-82010** 10.0 cm, smooth, 1x2 teeth



Graefe Iris

- H142-81010** 10.0 cm, serrated



Julian Suture

- H142-82511** 11.0 cm, smooth, curved



Adson-Graefe

- H110-20012** 12.0 cm, multi-toothed



Bishop-Harmon

- H142-94004** 8.5 cm, smooth, 1x2 teeth, fine
- H142-94006** 8.5 cm, smooth, 1x2 teeth



Green Fixation

- H143-07605** 10.0 cm, 5 mm tip, without lock
- H143-07610** 10.0 cm, 10 mm tip, without lock
- H143-07612** 10.0 cm, 12 mm tip, without lock
- H143-07805** 10.0 cm, 5 mm tip, with lock
- H143-07810** 10.0 cm, 10 mm tip, with lock
- H143-07812** 10.0 cm, 12 mm tip, with lock



Semken

- H110-26915** 15.0 cm, cross-serrated, 1x2 teeth, TC



McIndoe Dissecting

- H110-25815** 15.0 cm, serrated



Gillies Dissecting

- H110-27215** 15.0 cm, cross serrated, 1x2 teeth



General

- H110-11115** 15.0 cm, cross serrated, TC



Forceps / Thumb

H110-22417 Cushing
17.0 cm, cross serrated, TC 

H110-22217 Cushing
17.0 cm, serrated, Titanium 

H110-22517 Cushing
17.0 cm, angled, cross serrated, TC 

H110-22618 Taylor Cushing
18.5 cm, cross serrated, bayonet, TC 

H110-25317 Bonney
17.5 cm, cross serrated, 1x2 teeth, TC 

H110-11618 Potts-Smith
18.0 cm, cross serrated, TC
H110-11621 21.0 cm, cross serrated, TC
H110-11625 25.0 cm, cross serrated, TC 

Gerald

- H110-30618** 18.0 cm, cross serrated,
1x2 teeth, TC
- H110-30118** 18.0 cm, cross serrated, TC



Skinner

- H110-32323** 23.0 cm,
cross serrated,
1x2 teeth, TC



DeBakey Titanium

- H111-30015** 15.0 cm, 1.5 mm tip, Titanium
- H111-30020** 19.5 cm, 1.5 mm tip, Titanium
- H111-30024** 24.0 cm, 1.5 mm tip, Titanium
- H111-30315** 15.0 cm, 2.3 mm tip, Titanium
- H111-30320** 19.5 cm, 2.3 mm tip, Titanium
- H111-30324** 24.0 cm, 2.3 mm tip, Titanium



DeBakey

- H111-30616** 16.0 cm, 1.5 mm jaw
- H111-30620** 20.0 cm, 1.5 mm jaw
- H111-30624** 24.0 cm, 1.5 mm jaw
- H111-30816** 16.0 cm, 2.0 mm jaw
- H111-30820** 20.0 cm, 2.0 mm jaw
- H111-30824** 24.0 cm, 2.0 mm jaw
- H111-30830** 30.0 cm, 2.0 mm jaw
- H111-30416** 16.0 cm, 2.7 mm jaw
- H111-30420** 20.0 cm, 2.7 mm jaw
- H111-30424** 24.0 cm, 2.7 mm jaw
- H111-30430** 30.0 cm, 2.7 mm jaw
- H111-31016** 16.0 cm, 3.5 mm jaw
- H111-31020** 20.0 cm, 3.5 mm jaw
- H111-31024** 24.0 cm, 3.5 mm jaw
- H111-31030** 30.0 cm, 3.5 mm jaw



Forceps / Thumb

H144-20616 **Lucae-Jansen**
16.0 cm, serrated









H146-15420 **Jansen Gruenwald**
20.0 cm, serrated



H144-20614 **Lucae**
14.0 cm, serrated











Jewelers diamond dusted

- | | | |
|-------------------|---|--|
| H110-33525 |  | 11.5 cm, # 5A, very fine pointed tips |
| H110-33503 |  | 11.5 cm, # 3, straight, delicate tips |
| H110-33504 |  | 11.5 cm, # 4, straight, very fine tips |
| H110-33505 |  | 11.0 cm, # 5, straight, ultra fine tips |
| H110-33515 |  | 11.0 cm, # 5/45, angled, ultra fine tips |
| H110-33507 |  | 11.5 cm, # 7, curved, delicate tips |



Jewelers

- | | | |
|-------------------|---|--|
| H110-33201 |  | 11.5 cm, # 1, straight, standard tips |
| H110-33012 |  | 11.5 cm, # 3, straight, delicate tips |
| H110-33225 |  | 11.0 cm, # 5A, very fine pointed tips |
| H110-33010 |  | 10.5 cm, # 3C, straight, delicate tips |
| H110-33204 |  | 11.0 cm, # 4, straight, very fine tips |
| H110-33205 |  | 11.0 cm, # 5, straight, ultra fine tips |
| H110-33100 |  | 11.0 cm, # 5/45, angled, ultra fine tips |
| H110-33112 |  | 11.0 cm, # 7, curved, delicate tips |



Micro-Forceps

round handle, with tying platform

- | | |
|-------------------|---------------------------|
| H111-10415 | 15.0 cm, straight, smooth |
| H111-10818 | 18.0 cm, straight, smooth |
| H111-10515 | 15.0 cm, curved, smooth |
| H111-10918 | 18.0 cm, curved, smooth |



Nasal Rasps

Fomon

- H146-52201** 20.0 cm, #1 and #2, TC
- H146-52203** 20.0 cm, #3 and #4, TC
- H146-52205** 20.0 cm, #5 and #6, TC
- H146-52207** 20.0 cm, #7 and #8, TC



Glabella

- H146-50501** 21.5 cm, TC



Peet

- H146-50919** 19.0 cm, straight
- H146-50920** 19.0 cm, curved



Miller Colburn File

- H182-89501** 18.0 cm, #1
- H182-89502** 18.0 cm, #2
- H182-89503** 18.0 cm, #3
- H182-89504** 18.0 cm, #4
- H182-89505** 18.0 cm, #5



McIndoe

- H146-53018** 17.5 cm, forward cutting, straight



Maltz

16.5 cm,
backward cutting,
straight

H146-51916



Lamont

17.5 cm,
backward cutting, wide,
straight, aggressive teeth

H146-53101



Lamont

17.5 cm,
backward cutting, delicate,
straight, fine teeth

H146-53102



Lamont

17.5 cm,
backward cutting, straight,
fine teeth

H146-53103



Parkes

21.0 cm, # 4, backward cutting,
straight, TC

H146-50604

21.0 cm, # 5, backward cutting,
straight, TC

H146-50605

21.0 cm, # 8, backward cutting,
straight, TC

H146-50608



Nasal Rasps



Friedman

21.5 cm,
with coarse teeth
and lewis sweeper

H146-52521



Fomon

22.0 cm,
lightweight,
coarse

H146-52101



Fomon

21.0 cm,
lightweight,
fine

H146-52102



Wire Brush

for cleaning rasps

H128-41001



Retractors

Ferreira retractor

H148-56411

11.0 cm x 2.2 cm, face lift retractor with fiberoptic



Flap retractor

H118-56112

11.0 cm, 2.2 cm blade



Tebbetts Style

T-Mammoplasty retractor with smoke evacuation tube and fiberoptic illumination, with Storz, HSW, ACMI adapter included

H118-55080

16 x 80 mm blade, without teeth

H118-55090

24 x 90 mm blade, without teeth

H118-55092

30 x 90 mm blade, without teeth

H118-55100

24 x 100 mm blade, without teeth

H118-55120

25 x 120 mm blade, without teeth

H118-55122

30 x 120 mm blade, without teeth

H118-55150

25 x 150 mm blade, without teeth

H118-55152

30 x 150 mm blade, without teeth

H118-55154

36 x 150 mm blade, without teeth

H118-55170

40 x 170 mm blade, without teeth

H118-55190

30 x 190 mm blade, without teeth

H118-55480

16 x 80 mm blade, with teeth

H118-55490

24 x 90 mm blade, with teeth

H118-55492

30 x 90 mm blade, with teeth

H118-55500

24 x 100 mm blade, with teeth

H118-55520

25 x 120 mm blade, with teeth

H118-55522

30 x 120 mm blade, with teeth

H118-55550

25 x 150 mm blade, with teeth

H118-55552

30 x 150 mm blade, with teeth

H118-55554

36 x 150 mm blade, with teeth

H118-55570

40 x 170 mm blade, with teeth

H118-55590

30 x 190 mm blade, with teeth



H118-17925

Deaver
20.0 cm, retractor with fiberoptic



H118-19612

Freeman Flap
20.5 cm,
retractor, 12 mm blade width

H118-19625

retractor, 25 mm blade width



H118-56019

Multiple approach retractor
19.0 cm, 23 mm blade



Retractors

Biggs Mammoplasty Retractor

- H118-57001** standard blade, 50 mm
- H118-57011** standard blade with fiber-optics, 50 mm
- H118-57021** standard blade with fiber-optics and suction tube, 50 mm
- H118-57002** narrow blade, 31 mm
- H118-57012** narrow blade with fiber-optics, 31 mm
- H118-57022** narrow blade with fiber-optics and suction tube, 31 mm



Converse

- H146-54105** 11.0 cm, nasal retractor, 11x44 mm blade
- H146-54125** 11.0 cm, nasal retractor, 11x44 mm blade, with fiber optics



Aufricht

- H146-55116** 16.0 cm, nasal retractor, 45 mm blade
- H146-55126** 16.0 cm, nasal retractor, 45 mm blade, with fiber optics



Cottle

- H146-55920** 20.0 cm, retractor with knife guard



- H118-65010** **Weitlaner**
11.5 cm, retractor,
2x3 sharp prongs
- H118-67014**
14.0 cm, retractor,
3x4 sharp prongs



- H146-55508** **Swivel double hook**
8.0 cm, sharp, 10 mm

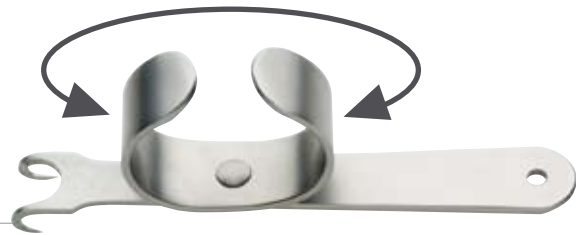

- H146-54516** **Sheen**
16.0 cm, nasal retractor



- H118-17731** **Spatula,**
semi-malleable
31.5 cm, 2.5x15.5 cm blade



Retractors

H118-19516 **Hamra**
16.0 cm, double ended retractor



H146-55614 **Cottle**
14.0 cm, retractor, double hook, sharp



H146-55616 **Fomon**
16.0 cm, alar retractor,
double hook with ball ends



H146-55412 **Converse Alar**
10.0 cm, retractor double ended,
10mm / 14mm, blunt



H146-55511 **Martinez Kilner**
11.5 cm, retractor double hook
with thimble, 10mm wide, sharp



U.S. Army
21.0 cm, retractor,
double ended, pair

H118-13121



Maxwell Flap
10.0 cm x 22 mm, four prongs retractor
10.0 cm x 38 mm, four prongs retractor

H118-25122

H118-25138



Freeman Rake
18.0 cm x 22 mm,
four prongs retractor
18.0 cm x 38 mm,
four prongs retractor

H118-25222

H118-25238



Anderson Bear Claw
11.0 cm, 3 prongs, sharp
11.0 cm, 5 prongs, sharp

H118-24911

H118-25011



Retractors

H146-56502 Freeman
10.0 cm, double skin hook, sharp



H118-25615 Yancoskie lift retractor
15.0 cm, 6 prongs



H118-25318 Lift retractor
18.0 cm, 7 prongs



H118-25438 **Gorney Rake**
7.5 cm, retractor with spring, 38mm wide



H142-37613 **Rollet**
13.0 cm, retractor, delicate, 4 sharp prongs



H118-26513 **Miller Rake**
13.5 cm, tissue retractor, delicate, 9 sharp prongs



H118-24214 **Ragnell**
15.0 cm, double ended retractor, delicate



H118-24314 **Ragnell-Davis**
14.5 cm, double ended retractor



Retractors

H118-16017 **Senn**
17.0 cm,
double ended retractor, sharp

H118-16117
17.0 cm,
double ended retractor,
blunt



H118-63510 **Holtzheimer**
self retaining retractor, 4 teeth

H118-63410 10.0 cm, blunt, straight

H118-63710 10.0 cm, sharp, straight

H118-63710 10.0 cm, blunt, curved

H118-63610 10.0 cm, sharp, curved



H118-80120 **Farr Spring Retractor**
14.0 cm x 2.0 cm

H118-80121 14.0 cm x 3.0 cm

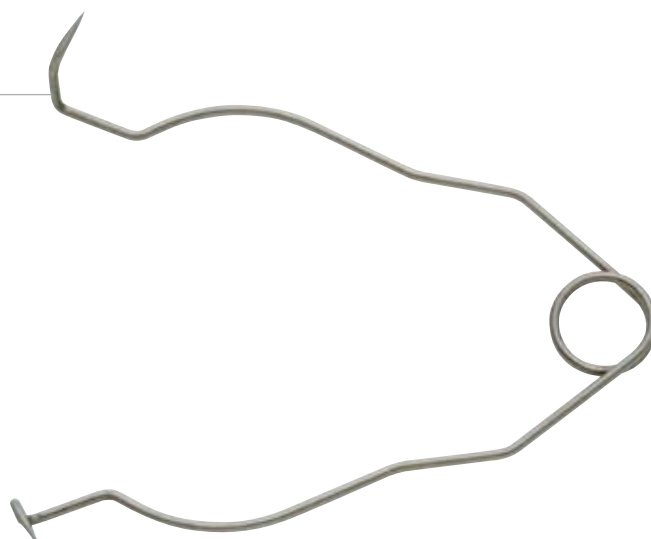

H118-24316 **Kasden**
16.5 cm,
double ended retractor



H118-23908 **Kawamoto**
16.0 cm,
double ended retractor,
insulated, 8mm/10mm blades



H118-23914 **Kawamoto**
16.0 cm,
double ended retractor,
insulated, 14mm/16mm blades



H148-58716 **Wise**
16.5 cm, orbit retractor,
double ended



H148-90301 **Hajek's**
18.0 cm, cheek retractor



Retractors



H148-32400

Dingman Mouth Gag complete
16.6 cm frame, 3 tongue blades

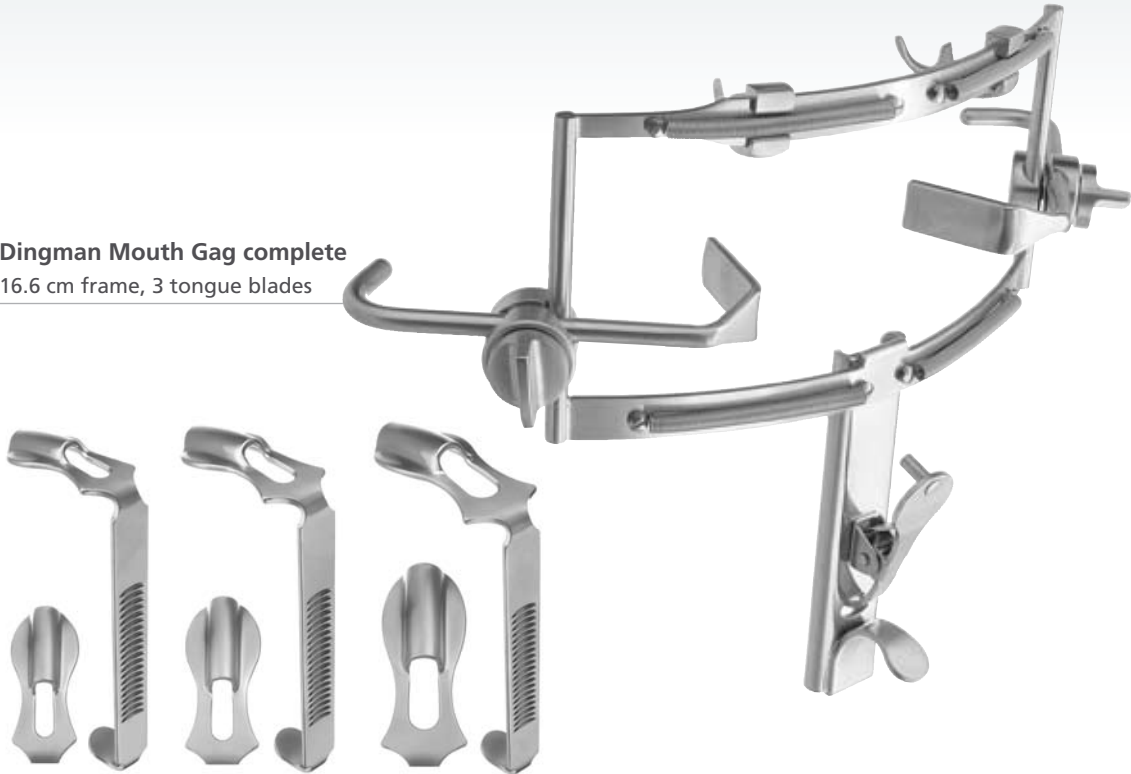

H132-45001
H132-45002

Lead Hand
adult size
child size



Breast Retractors

H138-30133
H138-30142

33.0 cm, angled
42.0 cm, angled



H138-30233
H138-30242

33.0 cm,
angled, malleable
42.0 cm,
angled, malleable



H138-30333
H138-30342

33.0 cm,
angled, insulated
42.0 cm,
angled, insulated



H138-31133

33.0 cm,
spatulated

H138-31142

42.0 cm,
spatulated



H138-31233

33.0 cm,
spatulated, malleable

H138-31242

42.0 cm, spatulated,
malleable



H138-31333

33.0 cm,
spatulated, insulated

H138-31342

42.0 cm, spatulated,
insulated



H138-31432

32.0 cm,
oval spatulated
blade



Shaper

H138-32001	Scalp Dissector 24.0 cm, slightly curved, 12.5 mm wide	
H138-32011	24.0 cm, slightly curved, 12.5 mm wide, with Ergo Handle	
H138-32002	Scalp Dissector 24.0 cm, half curved, with angled tip, 12.5 mm wide	
H138-32012	24.0 cm, half curved, with angled tip, 12.5 mm wide, with Ergo Handle	
H138-32003	Dissector 24.0 cm, half curved, 7.0 mm wide	
H138-32013	24.0 cm, half curved, 7.0 mm wide, with Ergo Handle	
H138-32004	Transoral Dissector 23.5 cm, curved, 7.0 mm wide	
H138-32014	23.5 cm, curved, 7.0 mm wide, with Ergo Handle	
H138-32005	Dissector 24.0 cm, straight, 7.0 mm wide	
H138-32015	24.0 cm, straight, 7.0 mm wide, with Ergo Handle	

H138-32006 **Flap Dissector**
24.0 cm, curved, 6.5 mm wide
H138-32016 24.0 cm, curved, 6.5 mm wide,
with Ergo Handle

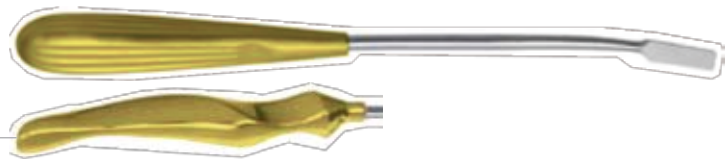

H138-32007 **Frontoglobellar Dissector**
26.5 cm, S-shaped
H138-32017 26.5 cm, S-shaped,
with Ergo Handle

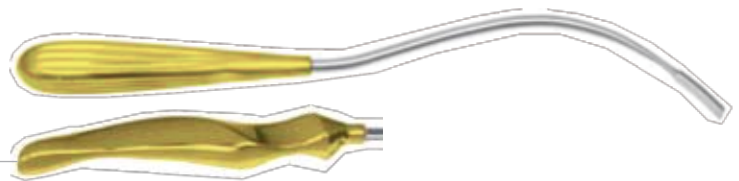

H138-32008 **Midface Fascia Dissector**
24.0 cm, S-shaped
H138-32018 24.0 cm, S-shaped,
with Ergo Handle

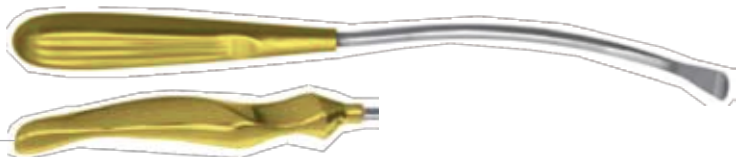

H138-32009 **Flap Dissector**
22.5 cm, straight, 10 mm wide
H138-32019 22.5 cm, straight, 10 mm wide,
with Ergo Handle

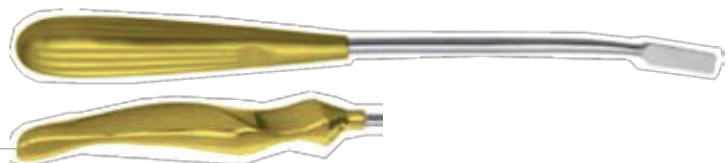

H138-32101 **Periosteal Dissector**
24.0 cm, S-shaped, 9 mm wide
H138-32111 24.0 cm, S-shaped, 9 mm wide,
with Ergo Handle

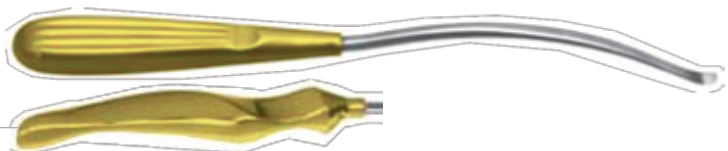

Shaper

- H138-32102** **Nerve Dissector**
24.0 cm, slightly curved
- H138-32112** 24.0 cm, slightly curved,
with Ergo Handle

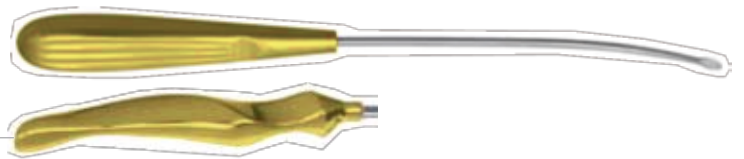

- H138-32103** **Orbital Rim Dissector**
24.0 cm, half curved
- H138-32113** 24.0 cm, half curved,
with Ergo Handle

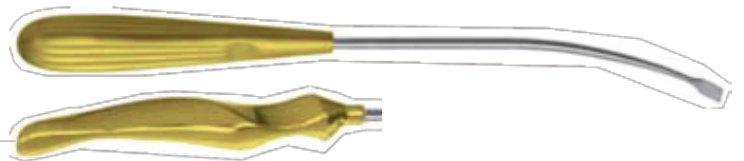

- H138-32104** **Temporal Dissector**
23.5 cm, straight
- H138-32114** 23.5 cm, straight,
with Ergo Handle

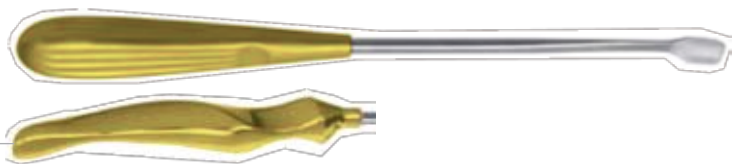

- H138-32105** **Periosteal Dissector**
25.0 cm, curved
- H138-32115** 25.0 cm, curved,
with Ergo Handle

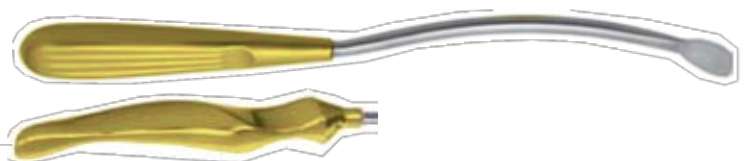

H138-33001 Nerve Hook
24.0 cm, curved right
H138-33002 24.0 cm, curved left



H138-33123 Nerve Hook
23.5 cm, slightly malleable,
with graduation



H138-33501 Nerve Protector
17.0 cm, curved right
H138-33502 17.0 cm, curved left



H138-34001 Suction Elevator
slightly curved, round edge



H138-35023 Scalpel Handle
23.0 cm,
for small blades, downwards angled



Osteotomes

Anderson-Neivert

H146-46907 20.0 cm, straight
H146-46917 20.0 cm, right
H146-46927 20.0 cm, left



Gunter

H146-46307 21.5 cm, straight
H146-46317 21.5 cm, right
H146-46327 21.5 cm, left



Silver rhinoplastic chisel

H146-47301 18.0 cm, straight
H146-47302 18.0 cm, right
H146-47303 18.0 cm, left



Ristow

H146-47701 20.5 cm, right
H146-47702 20.5 cm, left



Rees

handle aluminium anodized
H146-44802 20.5 cm, 2 mm
H146-44803 20.5 cm, 3 mm



Parkes

H146-47518

16.0 cm, straight



Converse

H146-47102

18.0 cm, 2 mm

H146-47103

18.0 cm, 3 mm

H146-47104

18.0 cm, 4 mm

H146-47105

18.0 cm, 5 mm

H146-47106

18.0 cm, 6 mm

H146-47107

18.0 cm, 7 mm

H146-47108

18.0 cm, 8 mm

H146-47109

18.0 cm, 9 mm

H146-47110

18.0 cm, 10 mm

H146-47111

18.0 cm, 11 mm

H146-47112

18.0 cm, 12 mm

H146-47115

18.0 cm, 15 mm



Sheehan

H146-46702

16.0 cm, 2 mm

H146-46703

16.0 cm, 3 mm

H146-46704

16.0 cm, 4 mm

H146-46705

16.0 cm, 5 mm

H146-46706

16.0 cm, 6 mm

H146-46709

16.0 cm, 9 mm

H146-46710

16.0 cm, 10 mm



Osteotomes

Cinelli

H146-47210	18.5 cm, 10 mm
H146-47212	18.5 cm, 12 mm
H146-47214	18.5 cm, 14 mm
H146-47216	18.5 cm, 16 mm



Rubin Type

H146-46810	17.0 cm, 10 mm
H146-46814	17.0 cm, 14 mm
H146-46816	17.0 cm, 16 mm



Parkes Gouge

H146-47918	18.0 cm, 6.5 mm
-------------------	-----------------



Sheen angled, Radix Chisel

H146-44710	18.0 cm, 10 mm, 10° angle
H146-44720	18.0 cm, 10 mm, 20° angle



Freer Chisel

H146-45004	16.5 cm, 4 mm, straight
-------------------	-------------------------



Mallets

H132-69632
H132-69702

Mead
17.0 cm, 320 g
pair of interchangeable faces



H132-69114

Nylon
18.5 cm, head Nylon / Nylon



H132-69214

Nylon
18.5 cm, head Nylon / Stainless



H132-68625

Gerzog
18.0 cm, 250 g = 8 oz



Morselizers

H146-25318 Gunter
18.0 cm, serrated, TC



H146-25520 Gorney
18.5 cm, straight



H146-53800 Cottle
cartilage-crusher, including forceps for removal



Saws

Joseph Saw

- H146-53219 19.0 cm, left bayonet
- H146-53419 19.0 cm, right bayonet



Curettes

Converse double ended curette

- H144-76321 21.0 cm, 7.0 x 10.0 and 6.5 x 8.5mm



Fox dermal curette

- H174-12803 14.0 cm, 3 mm oval
- H174-12804 14.0 cm, 4 mm oval
- H174-12805 14.0 cm, 5 mm oval



Septum Forceps

Asch straightening Forceps

- H146-57123 23.0 cm



Walsham straightening Forceps

- H146-57223 23.0 cm, straight
- H146-57323 23.0 cm, left
- H146-57523 23.0 cm, right



Nasal Speculas

Vienna

- H146-11201** 14.0 cm, for baby
- H146-11202** 14.0 cm, for child
- H146-11203** 14.0 cm, for adult



Killian

- H146-12035** 13.0 cm, 35 mm
- H146-12050** 13.0 cm, 50 mm
- H146-12075** 13.0 cm, 75 mm
- H146-12090** 13.0 cm, 90 mm



Cottle

- H146-12435** 14.0 cm, 35 mm
- H146-12450** 14.0 cm, 50 mm
- H146-12475** 14.0 cm, 75 mm
- H146-12490** 14.0 cm, 90 mm



Elevators



Elevators

H146-41645 **Freer**
19.0 cm, tip 4.5 mm,
sharp/blunt

H146-41665
19.0 cm, tip 6.5 mm,
sharp/blunt



H146-40418 **McCullough**
18.5 cm



H146-50318 **Woodson**
20.0 cm



H146-42519 **Cottle Skin**
19.0 cm, 10 mm wide



H146-43317 **Mitchells Trimmer**
17.0 cm, knife blade and spoon
shaped elevator



Obwegeser Periosteal

H148-69907
H148-69911

18.0 cm, 7 mm
18.0 cm, 11 mm



Boies

H146-57719

19.5 cm



Carlin

H148-56600

15.5 cm, chin implant
periosteal elevator



Clodius

H148-58500

orbital retractor, double ended,
13 mm / 20 mm



Hooks

Frazier Skin Hook

H118-21413 13.0 cm, sharp
H118-21418 18.0 cm, sharp



O'Conner Iris Skin Hook

H118-20913 12.5 cm, sharp



Converse Skin Hook

H118-20501 19.0 cm, small
H118-20503 19.0 cm, large



Joseph Skin Hook

H118-21601 16.0 cm, single hook
H118-21602 16.0 cm, 2 mm double hook
H118-21605 16.0 cm, 5 mm double hook
H118-21607 16.0 cm, 7 mm double hook
H118-21610 16.0 cm, 10 mm double hook



Kleinert-Kutz Hook

H118-20803 16.0 cm, 3 mm
H118-20805 16.0 cm, 5 mm
H118-20807 16.0 cm, 7 mm



Millard Thimble Hook

H146-55218

18 mm wide, double hook



Cottle Tenaculum

H146-55701

15.0 cm, Fig. 1

H146-55702

15.0 cm, Fig. 2

H146-55703

15.0 cm, Fig. 3



Guthrie Double Hook

H118-21201

12.0 cm, 2.5 mm

H118-21202

12.0 cm, 3.0 mm



Tyrell Skin Hook

H118-20413

13.0 cm



Gillies Skin Hook

H146-56018

18.0 cm, Fig. 1

H146-56218

18.0 cm, Fig. 2



Barsky Double Skin Hook

H146-56614

15.0 cm, 5 mm



Measuring

H102-31911 Thorpe Precision Caliper
12.5 cm



H142-58307 Castroviejo Caliper
9.0 cm



H102-31710 Jameson Caliper
10.0 cm



H102-31811 Thorpe Caliper, angled
12.0 cm



Dissectors



Markers

Grossmann
Areola Marker
4 sizes



Freeman
Areola Marker

H138-10534 34 mm
H138-10536 36 mm
H138-10538 38 mm
H138-10542 42 mm
H138-10545 45 mm
H138-10550 50 mm



McKissock "keyhole"
used in conjunction
with Freeman Areola Marker

H138-11038 38 mm
H138-11042 42 mm
H138-11045 45 mm

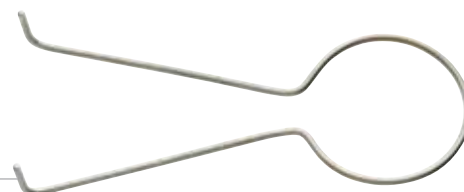

Freeman

H138-10738 38/42 mm diameter
H138-10742 42/45 mm diameter



Ackerman
Areola Marker

H138-11414 10.0 cm
H138-11416 11.5 cm

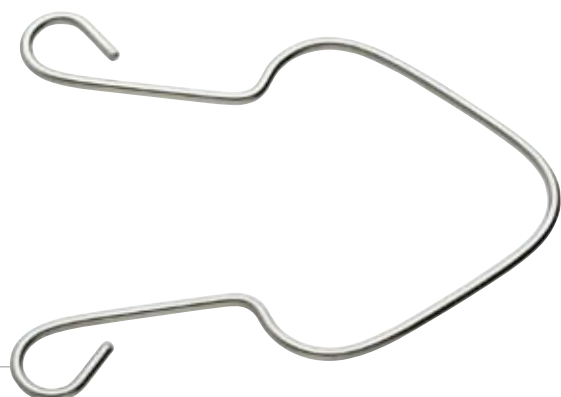

H138-20216
H138-20316

D'Assumpcao F/L
16.0 cm
16.0 cm, with ratchet



H138-20916

Pitanguy Flap Demarcator
16.0 cm, facial



H138-20714
H138-20614

Marten Flap
14.5 cm
14.5 cm, with ratchet



Forceps

H112-21010 Hartmann Mosquito 10.0 cm, straight
H112-21110 10.0 cm, curved



H112-23012 Halstead Mosquito 12.5 cm, straight, 1x2 teeth
H112-23112 12.5 cm, curved, 1x2 teeth
H112-22012 12.5 cm, straight
H112-22112 12.5 cm, curved



H112-24014 Kelly 14.0 cm, straight
H112-24114 14.0 cm, curved



H112-25014 Crile hemostatic forceps 14.0 cm, straight
H112-25114 14.0 cm, curved
H112-26316 16.0 cm, curved



Rochester Pean
hemostatic forceps

- H112-31014** 14.0 cm, straight
- H112-31016** 16.0 cm, straight
- H112-31020** 20.0 cm, straight
- H112-31116** 16.0 cm, curved
- H112-31118** 18.0 cm, curved
- H112-31120** 20.0 cm, curved



Rochester-Ochsner
hemostatic forceps

- H112-32014** 14.0 cm, straight, 1x2 teeth
- H112-32114** 14.0 cm, curved, 1x2 teeth
- H112-32016** 16.0 cm, straight, 1x2 teeth
- H112-32116** 16.0 cm, curved, 1x2 teeth



Adson
hemostatic forceps

- H112-41018** 18.5 cm, straight
- H112-41118** 18.5 cm, curved



Forceps

H154-52015
H154-52020

Lahey Vulsellum
15.0 cm
20.0 cm



H164-10214
H164-11015
H164-12015
H164-12019

Allis
14.0 cm, 4:5 teeth, Allis Baby
15.0 cm, 4:5 teeth
15.0 cm, 5:6 teeth
19.0 cm, 5:6 teeth



H114-11109
H114-11111
H114-11113
H114-11115

Backhaus Towel
9.0 cm
11.0 cm
13.0 cm
15.0 cm



Lorna Towel

H114-12111
H114-12113

11.0 cm
13.0 cm



Jones Towel

H114-10309

9.0 cm



Foerster Sponge Holding

H116-17018
H116-17020
H116-17025

18.0 cm
20.0 cm
25.0 cm



Knives

Ballenger Swivel

- H146-39003** 20.0 cm, straight, 3 mm blade
- H146-39004** 20.0 cm, straight, 4 mm blade
- H146-39005** 20.0 cm, straight, 5 mm blade
- H146-39203** 20.0 cm, bayonet, 3 mm blade
- H146-39204** 20.0 cm, bayonet, 4 mm blade
- H146-39205** 20.0 cm, bayonet, 5 mm blade



Freer Mucosa Knife

- H146-37415** 15.0 cm, "D" pattern



Silver Dermatome

- H106-48219** 19.0 cm





Rongeurs

H132-15016 Lempert
H132-15116 16.0 cm, straight
16.0 cm, curved



H132-20118 Beyer
18.0 cm, curved



Bone Cutting Forceps

H146-32519 **Jansen Middleton**
nasal cutting forceps
19.5 cm



H146-21002 **Takahashi Cutting Forceps**
11.5 cm, working length, 2.5x8 mm bite



H132-28314 **Kleinert-Kutz Forceps**
14.0 cm, straight
H132-28414 14.0 cm, curved



Miscellaneous

Ruler
graduated in mm and inches

- H102-34010** 10.0 cm
- H102-34020** 20.0 cm
- H102-34030** 30.0 cm
- H102-34050** 50.0 cm



Barron Suction Tubes

- H144-10103** 13.0 cm, 3 french
- H144-10105** 13.0 cm, 5 french
- H144-10107** 13.0 cm, 7 french



Yankauer Aspiration Tube
27.0 cm, complete with suction tip and connector

- H104-15027**



H133-53820

Universal Flat Nose Pliers
20.0 cm



H133-53202
H133-53203

Wire Seizing Forceps
18.0 cm, 4 mm
18.0 cm, 6 mm



H133-56814

Needle Nose Pliers
14.0 cm, cross-serrated



Miscellaneous

H133-53803 General Purpose Pliers
18.0 cm



H133-54717 Wire/Pin Cutter
18.0 cm, 1.7 wire, TC
H133-54522 22.0 cm, 2.5 wire, TC



H133-54618 Wire/Pin Cutter
18.0 cm, TC



Cannulas / Lipo Suction

Lipo Hand piece

with lever mechanism,
quick lock mechanism

H138-40010



with thumb control,
quick lock mechanism

H138-40020



Triport

working length Ø

H138-41315	150 mm	3 mm
H138-41320	200 mm	3 mm
H138-41325	250 mm	3 mm
H138-41330	300 mm	3 mm
H138-41420	200 mm	4 mm
H138-41425	250 mm	4 mm
H138-41430	300 mm	4 mm
H138-41525	250 mm	5 mm
H138-41530	300 mm	5 mm



Monoport

working length Ø

H138-42315	150 mm	3 mm
H138-42320	200 mm	3 mm
H138-42325	250 mm	3 mm
H138-42330	300 mm	3 mm
H138-42420	200 mm	4 mm
H138-42425	250 mm	4 mm
H138-42430	300 mm	4 mm
H138-42525	250 mm	5 mm
H138-42530	300 mm	5 mm



Cannulas / Lipo Suction

Cobra

working length Ø

H138-43315	150 mm	3 mm
H138-43320	200 mm	3 mm
H138-43325	250 mm	3 mm
H138-43420	200 mm	4 mm
H138-43425	250 mm	4 mm
H138-43430	300 mm	4 mm
H138-43525	250 mm	5 mm
H138-43530	300 mm	5 mm



Spirale

working length Ø

H138-44315	150 mm	3 mm
H138-44320	200 mm	3 mm
H138-44325	250 mm	3 mm
H138-44420	200 mm	4 mm
H138-44425	250 mm	4 mm
H138-44430	300 mm	4 mm
H138-44525	250 mm	5 mm
H138-44530	300 mm	5 mm



Shark

working length Ø

H138-45315	150 mm	3 mm
H138-45320	200 mm	3 mm
H138-45325	250 mm	3 mm
H138-45420	200 mm	4 mm
H138-45425	250 mm	4 mm
H138-45430	300 mm	4 mm
H138-45525	250 mm	5 mm
H138-45530	300 mm	5 mm



Lipo Hand piece
with thumb control,
luer lock

H138-40030



Triport

working length Ø

H138-46320	200 mm	3 mm
H138-46325	250 mm	3 mm
H138-46420	200 mm	4 mm
H138-46425	250 mm	4 mm
H138-46430	300 mm	4 mm
H138-46525	250 mm	5 mm
H138-46530	300 mm	5 mm



Mercedes

working length Ø

H138-47320	200 mm	3 mm
H138-47325	250 mm	3 mm
H138-47420	200 mm	4 mm
H138-47425	250 mm	4 mm
H138-47430	300 mm	4 mm
H138-47525	250 mm	5 mm
H138-47530	300 mm	5 mm



Spirale

working length Ø

H138-48320	200 mm	3 mm
H138-48325	250 mm	3 mm
H138-48420	200 mm	4 mm
H138-48425	250 mm	4 mm
H138-48430	300 mm	4 mm
H138-48525	250 mm	5 mm
H138-48530	300 mm	5 mm



Order Number Index

art.-no.	page	art.-no.	page	art.-no.	page	art.-no.	page	art.-no.	page
H102-31710	70	H108-21220	4	H108-28615	13	H108-39518	10	H110-18805	29
H102-31811	70	H108-21320	4	H108-28618	13	H108-40118	10	H110-18812	29
H102-31911	70	H108-21420	4	H108-28620	13	H108-40213	11	H110-18851	30
H102-34010	82	H108-21518	4	H108-28623	13	H108-40354	11	H110-20012	30
H102-34020	82	H108-21520	4	H108-28628	13	H108-40716	11	H110-20412	28
H102-34030	82	H108-21523	4	H108-28715	13	H108-53916	9	H110-20512	28
H102-34050	82	H108-21617	17	H108-28718	13	H108-80209	16	H110-22217	32
H104-15027	82	H108-21620	4	H108-28720	13	H108-82313	6	H110-22417	32
H106-10301	79	H108-21720	4	H108-28723	13	H108-83512	15	H110-22517	32
H106-10303	79	H108-21818	6	H108-28728	13	H108-90114	17	H110-22618	32
H106-48219	78	H108-21820	6	H108-30414	9	H108-90118	17	H110-25317	32
H106-48230	79	H108-21918	4	H108-30454	9	H108-93114	16	H110-25815	31
H106-48401	79	H108-22018	4	H108-30514	9	H109-20615	17	H110-26915	31
H107-17017	14	H108-22417	5	H108-30554	9	H109-20618	17	H110-27215	31
H107-17117	14	H108-22419	5	H108-30612	9	H109-20715	17	H110-30118	33
H107-28015	12	H108-22517	5	H108-31212	8	H109-20718	17	H110-30618	33
H107-28018	12	H108-22519	5	H108-31412	8	H109-20815	17	H110-32323	33
H107-28023	12	H108-23312	5	H108-32209	16	H109-20818	17	H110-33010	35
H107-28115	12	H108-23315	5	H108-32309	16	H109-20915	17	H110-33012	35
H107-28118	12	H108-23323	5	H108-32610	16	H109-20918	17	H110-33100	35
H107-28123	12	H108-24018	6	H108-32710	16	H110-11115	31	H110-33112	35
H107-37411	8	H108-24516	5	H108-34011	8	H110-11618	32	H110-33201	35
H107-37511	8	H108-24520	5	H108-34111	8	H110-11621	32	H110-33204	35
H108-10614	15	H108-24816	6	H108-34211	8	H110-11625	32	H110-33205	35
H108-10714	15	H108-27415	13	H108-34251	8	H110-16912	29	H110-33225	35
H108-11214	14	H108-27418	13	H108-34311	8	H110-17012	28	H110-33503	35
H108-11314	14	H108-27423	13	H108-34351	8	H110-17312	29	H110-33504	35
H108-12214	15	H108-27515	13	H108-34411	8	H110-17315	29	H110-33505	35
H108-12314	15	H108-27518	13	H108-34511	8	H110-17412	28	H110-33507	35
H108-17415	13	H108-27523	13	H108-35010	10	H110-17415	28	H110-33515	35
H108-17417	13	H108-28415	12	H108-36011	7	H110-17452	29	H110-33525	35
H108-17515	13	H108-28418	12	H108-36051	7	H110-17455	29	H111-10415	35
H108-17517	13	H108-28420	12	H108-36111	7	H110-17512	28	H111-10515	35
H108-19421	14	H108-28423	12	H108-36151	7	H110-17515	28	H111-10818	35
H108-19521	14	H108-28428	12	H108-36211	7	H110-17612	28	H111-10918	35
H108-20512	16	H108-28515	12	H108-36311	7	H110-17912	28	H111-30015	33
H108-20514	16	H108-28518	12	H108-36509	15	H110-18012	28	H111-30020	33
H108-20911	7	H108-28520	12	H108-36512	15	H110-18512	29	H111-30024	33
H108-20914	7	H108-28523	12	H108-37411	8	H110-18612D	29	H111-30315	33
H108-21011	7	H108-28528	12	H108-37511	8	H110-18802	29	H111-30320	33

art.-no.	page	art.-no.	page	art.-no.	page	art.-no.	page	art.-no.	page
H111-30324	33	H114-11113	76	H118-25222	45	H118-65010	43	H124-24817	21
H111-30416	33	H114-11115	76	H118-25238	45	H118-67014	43	H124-24819	21
H111-30420	33	H114-12111	77	H118-25318	46	H118-80120	48	H124-41414	23
H111-30424	33	H114-12113	77	H118-25438	47	H118-80121	48	H124-41418	23
H111-30430	33	H116-17018	77	H118-25615	46	H122-32014	75	H124-43416	23
H111-30616	33	H116-17020	77	H118-26513	47	H122-32114	75	H124-63414	25
H111-30620	33	H116-17025	77	H118-55080	40	H124-11012	19	H124-63415	25
H111-30624	33	H118-13121	45	H118-55090	40	H124-11412	19	H124-63418	25
H111-30816	33	H118-16017	48	H118-55092	40	H124-12811	18	H124-63514	25
H111-30820	33	H118-16117	48	H118-55100	40	H124-12913	18	H124-63515	25
H111-30824	33	H118-17731	43	H118-55120	40	H124-13413	18	H124-63518	25
H111-30830	33	H118-17925	41	H118-55122	40	H124-14011	18	H124-63614	25
H111-31016	33	H118-19516	44	H118-55150	40	H124-14013	18	H124-63615	25
H111-31020	33	H118-19612	41	H118-55152	40	H124-14413	18	H124-63618	25
H111-31024	33	H118-19625	41	H118-55154	40	H124-14713	19	H124-63714	25
H111-31030	33	H118-20413	69	H118-55170	40	H124-15412	22	H124-63715	25
H112-21010	74	H118-20501	68	H118-55190	40	H124-15414	22	H124-63718	25
H112-21110	74	H118-20503	68	H118-55480	40	H124-16215	21	H124-64014	24
H112-22012	74	H118-20803	68	H118-55490	40	H124-16415	21	H124-64015	24
H112-22112	74	H118-20805	68	H118-55492	40	H124-16418	21	H124-64018	24
H112-23012	74	H118-20807	68	H118-55500	40	H124-16420	21	H124-64114	24
H112-23112	74	H118-20913	68	H118-55520	40	H124-16423	21	H124-64115	24
H112-24014	74	H118-21201	69	H118-55522	40	H124-18414	22	H124-64118	24
H112-24114	74	H118-21202	69	H118-55550	40	H124-18416	22	H124-64214	24
H112-25014	74	H118-21413	68	H118-55552	40	H124-18418	22	H124-64215	24
H112-25114	74	H118-21418	68	H118-55554	40	H124-18420	22	H124-64218	24
H112-26316	74	H118-21601	68	H118-55570	40	H124-21815	19	H124-64314	24
H112-31014	75	H118-21602	68	H118-55590	40	H124-22413	20	H124-64315	24
H112-31016	75	H118-21605	68	H118-56019	41	H124-22415	20	H124-64318	24
H112-31020	75	H118-21607	68	H118-56112	40	H124-22418	20	H124-65712	27
H112-31116	75	H118-21610	68	H118-57001	42	H124-22613	20	H124-65912	27
H112-31118	75	H118-23908	49	H118-57002	42	H124-22615	20	H124-66614	26
H112-31120	75	H118-23914	49	H118-57011	42	H124-22618	20	H124-66615	26
H112-32016	75	H118-24214	47	H118-57012	42	H124-23415	21	H124-66618	26
H112-32116	75	H118-24314	47	H118-57021	42	H124-23418	21	H124-66714	26
H112-41018	75	H118-24316	49	H118-57022	42	H124-23814	20	H124-66715	26
H112-41118	75	H118-24911	45	H118-63410	48	H124-23815	20	H124-66718	26
H114-10309	77	H118-25011	45	H118-63510	48	H124-23818	20	H124-66814	26
H114-11109	76	H118-25122	45	H118-63610	48	H124-23820	20	H124-66815	26
H114-11111	76	H118-25138	45	H118-63710	48	H124-24814	21	H124-66818	26

Order Number Index

art.-no.	page	art.-no.	page	art.-no.	page	art.-no.	page	art.-no.	page
H124-66914	26	H133-53820	83	H138-30233	52	H138-32115	56	H138-44325	86
H124-66915	26	H133-53901	23	H138-30242	52	H138-33001	57	H138-44420	86
H124-66918	26	H133-53902	23	H138-30333	52	H138-33002	57	H138-44425	86
H124-67513	26	H133-53903	23	H138-30342	52	H138-33123	57	H138-44430	86
H124-67514	26	H133-54522	84	H138-31133	53	H138-33501	57	H138-44525	86
H124-67517	26	H133-54618	84	H138-31142	53	H138-33502	57	H138-44530	86
H124-67518	26	H133-54717	84	H138-31233	53	H138-34001	57	H138-45315	86
H124-67813	26	H133-56814	83	H138-31242	53	H138-35023	57	H138-45320	86
H124-67814	26	H133-60001	22	H138-31333	53	H138-40010	85	H138-45325	86
H124-67817	26	H133-60002	22	H138-31342	53	H138-40020	87	H138-45420	86
H124-67819	26	H133-60011	22	H138-31432	53	H138-41315	85	H138-45425	86
H124-69614	27	H133-60012	22	H138-32001	54	H138-41320	85	H138-45430	86
H124-69618	27	H138-10400	72	H138-32002	54	H138-41325	85	H138-45525	86
H124-69714	27	H138-10534	72	H138-32003	54	H138-41330	85	H138-45530	86
H124-69718	27	H138-10536	72	H138-32004	54	H138-41420	85	H138-46320	87
H124-69814	27	H138-10538	72	H138-32005	54	H138-41425	85	H138-46325	87
H124-69818	27	H138-10542	72	H138-32006	55	H138-41430	85	H138-46420	87
H124-69914	27	H138-10545	72	H138-32007	55	H138-41525	85	H138-46425	87
H124-69918	27	H138-10550	72	H138-32008	55	H138-41530	85	H138-46430	87
H124-70214	27	H138-10738	72	H138-32009	55	H138-42315	85	H138-46525	87
H124-70218	27	H138-10742	72	H138-32011	54	H138-42320	85	H138-46530	87
H128-41001	39	H138-11038	72	H138-32012	54	H138-42325	85	H138-47320	87
H132-15016	80	H138-11042	72	H138-32013	54	H138-42330	85	H138-47325	87
H132-15116	80	H138-11045	72	H138-32014	54	H138-42420	85	H138-47420	87
H132-20118	80	H138-11414	72	H138-32015	54	H138-42425	85	H138-47425	87
H132-28314	81	H138-11416	72	H138-32016	55	H138-42430	85	H138-47430	87
H132-28414	81	H138-14027	79	H138-32017	55	H138-42525	85	H138-47525	87
H132-45001	51	H138-15030	71	H138-32018	55	H138-42530	85	H138-47530	87
H132-45002	51	H138-15041	71	H138-32019	55	H138-43315	86	H138-48320	87
H132-68625	61	H138-15536	71	H138-32101	55	H138-43320	86	H138-48325	87
H132-69114	61	H138-16033	71	H138-32102	56	H138-43325	86	H138-48420	87
H132-69214	61	H138-20216	73	H138-32103	56	H138-43420	86	H138-48425	87
H132-69632	61	H138-20316	73	H138-32104	56	H138-43425	86	H138-48430	87
H132-69702	61	H138-20614	73	H138-32105	56	H138-43430	86	H138-48525	87
H132-81921	65	H138-20714	73	H138-32111	55	H138-43525	86	H138-48530	87
H133-53202	83	H138-20916	73	H138-32112	56	H138-43530	86	H142-37613	47
H133-53203	83	H138-30133	52	H138-32113	56	H138-44315	86	H142-58307	70
H133-53803	84	H138-30142	52	H138-32114	56	H138-44320	86	H142-81010	30

art.-no.	page	art.-no.	page	art.-no.	page	art.-no.	page	art.-no.	page
H142-82010	30	H146-37415	78	H146-47103	59	H146-52401	38	H148-56600	67
H142-82511	30	H146-39003	78	H146-47104	59	H146-52402	38	H148-57215	50
H142-94004	31	H146-39004	78	H146-47105	59	H146-52521	39	H148-57701	50
H142-94006	31	H146-39005	78	H146-47106	59	H146-53018	36	H148-58500	67
H143-07605	31	H146-39203	78	H146-47107	59	H146-53101	37	H148-58716	49
H143-07610	31	H146-39204	78	H146-47108	59	H146-53102	37	H148-69907	67
H143-07612	31	H146-39205	78	H146-47109	59	H146-53103	37	H148-69911	67
H143-07805	31	H146-40119	65	H146-47110	59	H146-53219	63	H148-90301	49
H143-07810	31	H146-40418	66	H146-47111	59	H146-53419	63	H148-90416	50
H143-07812	31	H146-41645	66	H146-47112	59	H146-53800	62	H154-52015	76
H143-14903	30	H146-41665	66	H146-47115	59	H146-54105	42	H154-52020	76
H143-14905	30	H146-42123	65	H146-47210	60	H146-54125	42	H164-10214	76
H143-14909	30	H146-42516	65	H146-47212	60	H146-54516	43	H164-11015	76
H143-14915	30	H146-42519	66	H146-47214	60	H146-54615	50	H164-12015	76
H144-10103	82	H146-43124	65	H146-47216	60	H146-55116	42	H164-12019	76
H144-10105	82	H146-43317	66	H146-47301	58	H146-55126	42	H174-12803	63
H144-10107	82	H146-44710	60	H146-47302	58	H146-55218	69	H174-12804	63
H144-20614	34	H146-44720	60	H146-47303	58	H146-55412	44	H174-12805	63
H144-20616	34	H146-44802	58	H146-47518	59	H146-55508	43	H182-89501	36
H144-76321	63	H146-44803	58	H146-47701	58	H146-55511	44	H182-89502	36
H146-11201	64	H146-45004	60	H146-47702	58	H146-55614	44	H182-89503	36
H146-11202	64	H146-46307	58	H146-47918	60	H146-55616	44	H182-89504	36
H146-11203	64	H146-46317	58	H146-50318	66	H146-55701	69	H182-89505	36
H146-12035	64	H146-46327	58	H146-50501	36	H146-55702	69		
H146-12050	64	H146-46702	59	H146-50604	37	H146-55703	69		
H146-12075	64	H146-46703	59	H146-50605	37	H146-55920	42		
H146-12090	64	H146-46704	59	H146-50608	37	H146-56018	69		
H146-12435	64	H146-46705	59	H146-50919	36	H146-56218	69		
H146-12450	64	H146-46706	59	H146-50920	36	H146-56502	46		
H146-12475	64	H146-46709	59	H146-51022	38	H146-56614	69		
H146-12490	64	H146-46710	59	H146-51916	37	H146-56810	50		
H146-15420	34	H146-46810	60	H146-52101	39	H146-57123	63		
H146-21002	81	H146-46814	60	H146-52102	39	H146-57223	63		
H146-25318	62	H146-46816	60	H146-52201	36	H146-57323	63		
H146-25520	62	H146-46907	58	H146-52203	36	H146-57523	63		
H146-26120	12	H146-46917	58	H146-52205	36	H146-57719	67		
H146-26122	12	H146-46927	58	H146-52207	36	H148-32400	51		
H146-32519	81	H146-47102	59	H146-52321	38	H148-56411	40		

HERMANN
MEDIZINTECHNIK



Hermann Medizintechnik GmbH
Württembergische Straße 26
D-78567 Fridingen/Tuttlingen
GERMANY
Tel. ++49 - 74 63 / 99 67-0
Fax ++49 - 74 63 / 99 67-50
info@hermann-medizintechnik.de
www.hermann-medizintechnik.de