

RHINOLOGIE

RHINOLOGY

RHINOLOGIE

RINOLOGÍA

RINOLOGIA

Distributed in New Zealand by:



Cooper Medical Limited
57 Mahunga Drive
Mangere Bridge
Auckland 2022





Nasenspekula
 Nasal Specula
 Spécule nasaux
 Espéculos nasales
 Specoli nasali

RHINOLOGIE

RHINOLOGY

RHINOLOGIE

RINOLOGÍA

RINOLOGIA

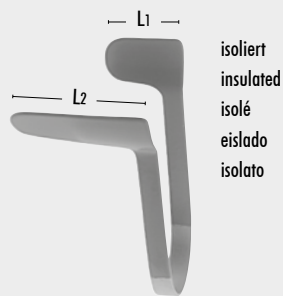
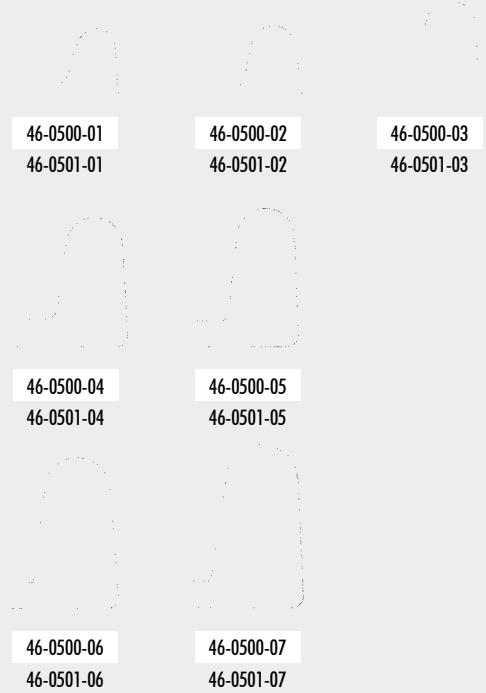
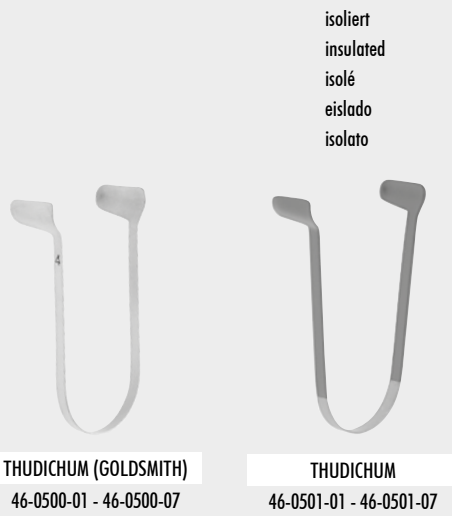

| SHAH | |
|------------|------------|
| 46-0502-01 | 46-0502-02 |
| L1 50,0 mm | L1 30,0 cm |
| L2 30,0 mm | L2 50,0 cm |



| x = mm | ST. CLAIR THOMSON |
|--------|-------------------|
| 38,0 | 46-0506-38 |
| 51,0 | 46-0506-51 |
| 64,0 | 46-0506-64 |
| 76,0 | 46-0506-76 |



46-0500-01

46.2

Nasenspekula
 Nasal Specula
 Spéculums nasaux
 Espéculos nasales
 Specoli nasali

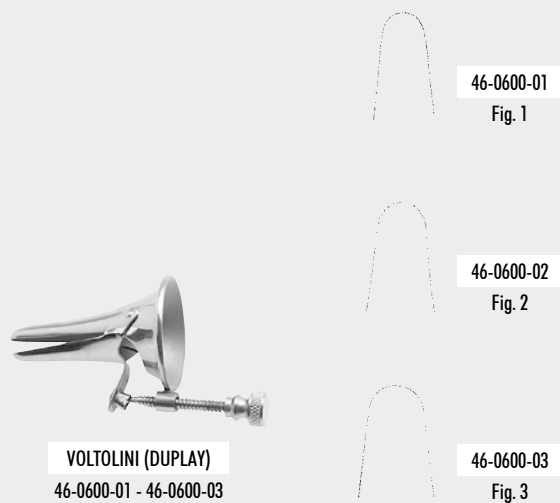

VOLTOLINI (DUPLAY)
 46-0600-01 - 46-0600-03

46-0600-01
 Fig. 1

46-0600-02
 Fig. 2

46-0600-03
 Fig. 3

RHINOLOGIE

RHINOLOGY

RHINOLOGIE

RINOLOGÍA

RINOLOGIA

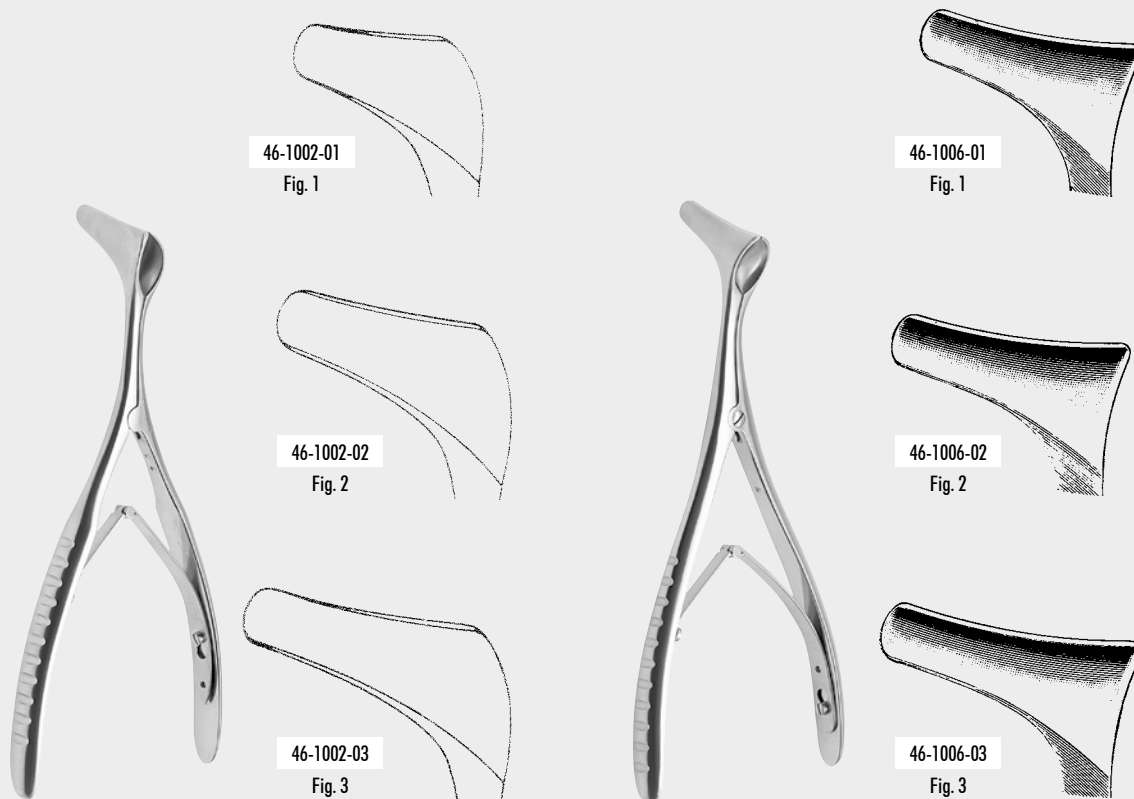

46-1002-01
 Fig. 1

46-1002-02
 Fig. 2

46-1002-03
 Fig. 3

46-1006-01
 Fig. 1

46-1006-02
 Fig. 2

46-1006-03
 Fig. 3

cm **HARTMANN-HALLE**
 15,0 46-1002-01 - 46-1002-03

cm **HARTMANN**
 15,0 46-1006-01 - 46-1006-03

ZEPF[®]

 INSTRUMENTS

46-1006-03

46.3

Nasenspekula
 Nasal Specula
 Spécule nasaux
 Espéculos nasales
 Specoli nasali

RHINOLOGIE



cm SONNENSCHN
 14,0 46-1008-15



cm MARTIN
 13,0 46-1012-01



cm BECKMANN (MARTIN)
 15,0 46-1013-01

RHINOLOGY

RHINOLOGIE

RINOLOGÍA

RINOLOGIA



BECKMANN
 46-1015-00 - 46-1015-03

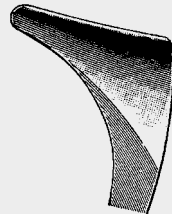

cm
 14,0 46-1015-00

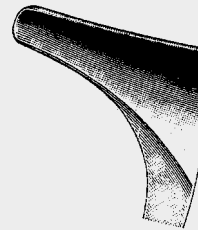

cm
 15,0 46-1015-02

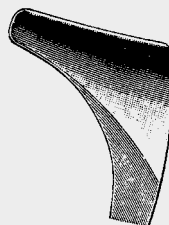

cm
 14,0 46-1015-01

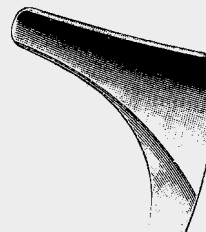

cm
 15,0 46-1015-03



mit Kaltlicht
with fibre light
à lumière froide
con luz fría
con luce fredda

Nasenspekula
Nasal Specula
Spéculums nasaux
Espéculos nasales
Specoli nasali

RHINOLOGIE

RHINOLOGY

RHINOLOGIE

RINOLOGÍA

RINOLOGIA

| Mod. Wien Vienna Vienne Viena | | | | | |
|-------------------------------|-------|------|------|------|------------|
| Baby | Bebe | | | | 46-1102-01 |
| Kind | child | enf. | niño | bamb | 46-1102-02 |
| Erw. | Adult | | | | 46-1102-03 |

| cm | Mod. Wien Vienna Vienne Viena |
|------|-------------------------------|
| 11,0 | 46-1102-11 |
| 12,0 | 46-1102-12 |
| 13,0 | 46-1102-13 |



| Mod. Wien Vienna Vienne Viena | |
|-------------------------------|---|
| 46-1103-03 | leichtes Modell light weight modèle léger modelo ligero modello leggero |

| cm | TIECK-HALLE |
|------|-------------|
| 13,5 | 46-1106-13 |

| cm | CARDIFF |
|------|------------|
| 13,0 | 46-1110-13 |

| cm | PILCHER |
|------|------------|
| 15,0 | 46-1120-15 |



46-1120-15

46.5



Nasen-, Septumspekula
 Nasal, Septum Specula
 Spéculums nasaux et de cloison
 Espéculos nasales y de tabique
 Specoli nasali e di setto

RHINOLOGIE

RHINOLOGY

RHINOLOGIE

RINOLOGÍA

RINOLOGIA



cm KILLIAN
 13,0 46-1200-35 - 46-1200-90

46-1200-35
 35 mm

46-1200-50
 50 mm

46-1200-75
 75 mm

46-1200-90
 90 mm

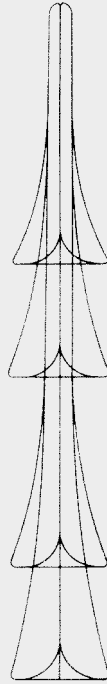

mit Kaltlicht
 with fibre light
 à lumière froide
 con luz fría
 con luce fredda

46-1202-35
 35 mm

46-1202-50
 50 mm

46-1202-75
 75 mm

46-1202-90
 90 mm



cm KILLIAN
 13,0 46-1202-35 - 46-1202-90

mit Kaltlicht - with fibre light -
 à lumière froide - con luz fría - con luce fredda
 STORZ / WOLF / OLYMPUS



cm COTTLE
 14,0 46-1204-35 - 46-1204-90



cm COTTLE
 14,0 46-1206-35 - 46-1206-90
 laser



46-1204-35
 46-1206-35
 35 mm

46-1204-50
 46-1206-50
 50 mm

46-1204-75
 46-1206-75
 75 mm

46-1204-90
 46-1206-90
 90 mm



46-1200-35

46.6



Nasenrachen-Spekulum
 Nasopharyngeal Speculum
 Spéculum nasopharyngien
 Espéculo nasofaringeal
 Specolo nasofaringeale

cm YANKAUER
 19,0 46-1301-19



cm MICHEL
 25,0 46-1309-12 - 46-1309-18



46-1309-12
 12 mm



46-1309-14
 14 mm



46-1309-16
 16 mm



46-1309-18
 18 mm

Postrhinoskopie-Spiegel - Mirror Post-Rhinoscopic
 Miroir postrhinoscopique - Espejo postrinoscópico
 Specchio postrinoscopico



| ø mm | St. CLAIRE THOMSON |
|---------|--------------------|
| 8,0 | 46-1311-08 |
| 10,0 | 46-1311-10 |
| 12,0 | 46-1311-12 |
| 14,0 | 46-1311-14 |
| 16,0 | 46-1311-16 |
| 18,0 cm | |

RHINOLOGIE

RHINOLOGY

RHINOLOGIE

RINOLOGÍA

RINOLOGIA



46-1311-16

46.7



Mit TC-Einsätzen
 TC Lined
 A mors TC
 Con bocas TC
 Con morso TC

Nasenpinzetten
 Nasal Forceps
 Pincas nasales
 Pinzas nasales
 Pinze nasali

RHINOLOGIE

RHINOLOGY

RHINOLOGIE

RINOLOGÍA

RINOLOGIA

Nasenzangen
 Nasal Forceps
 Pincas nasales
 Pinzas nasales
 Pinze nasali



cm TROELTSCH
 15,0 46-1501-15
 18,0 46-1501-18



cm JANSEN (GRÜNWALD)
 18,5 46-1504-18
 20,0 46-1504-20



cm GRÜNWALD
 20,0 46-1506-20



cm HARTMANN
 16,0 46-1601-16



cm HARTMANN
 20,0 46-1601-20



cm TILLEY
 17,0 46-1603-17



46-1501-15

46.8

Nasenzangen
 Nasal Forceps
 Pincas nasales
 Pinzas nasales
 Pinze nasali



cm LUBET-BARBON
 20,0 46-1605-20

cm LITTAUER
 18,0 46-1607-18

cm HEYMANN-KNIGHT
 18,0 46-1609-18

RHINOLOGIE

RHINOLOGY

RHINOLOGIE

RINOLOGÍA

RINOLOGIA

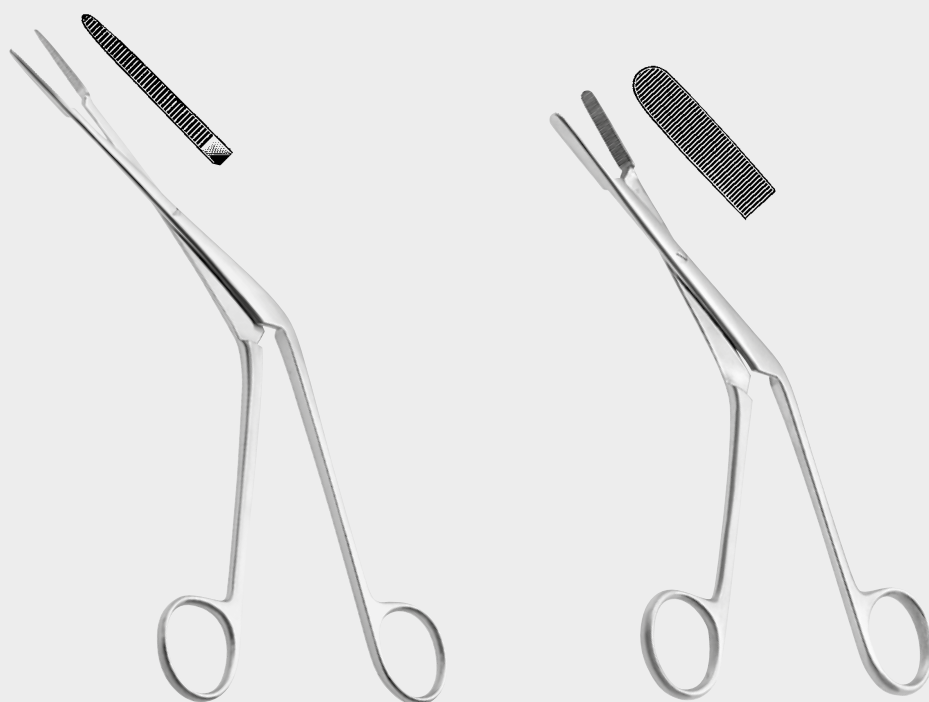

cm WESTMACOTT
 20,0 46-1611-20

cm KILLIAN
 17,0 46-1613-17

ZEPF®
α
 INSTRUMENTS

46-1613-17

46.9



Nasenzangen
Nasal Forceps
Pinces nasales
Pinzas nasales
Pinze nasali



cm CRAIG
18,0 46-1615-18



46-1621-18 46-1623-18

cm
18,0 46-1621-18 - 46-1623-18

RHINOLOGIE

RHINOLOGY

RHINOLOGIE

RINOLOGÍA

RINOLOGIA



46-1631-01

46-1631-02

WATSON WILLIAMS
46-1631-01 - 46-1631-02



46-1701-14

1:2



46-1703-14



cm NOYES
14,5 46-1701-14 - 46-1703-14



46-1615-18

46.10

Nasenzangen
Nasal Forceps
Pinces nasales
Pinzas nasales
Pinze nasali



46-1801-01



46-1801-02



46-1801-03



cm HEYMANN
18,0 46-1801-01 - 46-1801-03



cm HARTMANN
19,0 46-1710-19

RHINOLOGIE

RHINOLOGY

RHINOLOGIE

RINOLOGÍA

RINOLOGIA



46-1901-01

46-1901-02

46-1901-03



46-1901-04

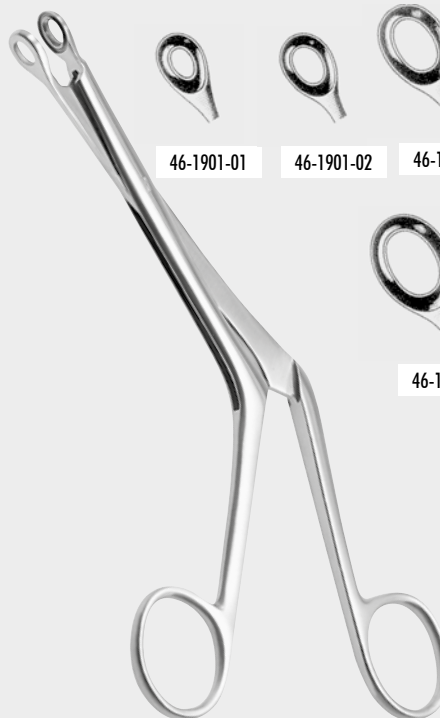

cm BRUENINGS
19,0 46-1901-01 - 46-1901-04



cm KNIGHT
18,0 46-1805-18



46-1901-04

46.11



Nasenzangen
Nasal Forceps
Pincas nasales
Pinzas nasales
Pinze nasali

RHINOLOGIE

RHINOLOGY

RHINOLOGIE

RINOLOGÍA

RINOLOGIA



mm LUC 20,0 cm
6 46-1903-01
7,5 46-1903-02
9 46-1903-03

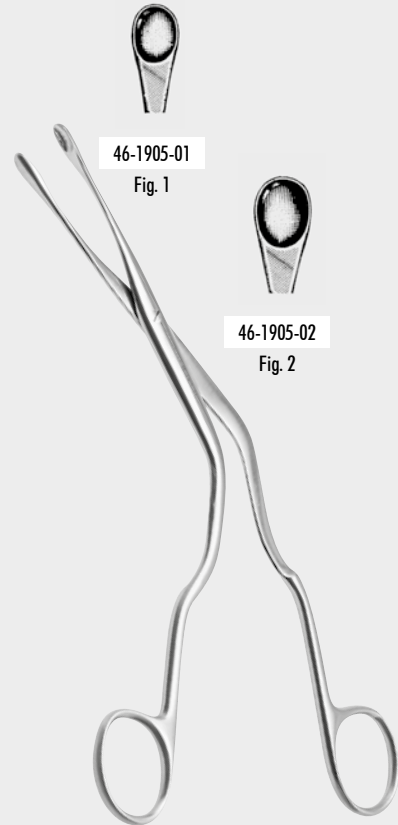

46-1905-01
Fig. 1

46-1905-02
Fig. 2

cm LUC
20,0 46-1905-01 - 46-1905-02

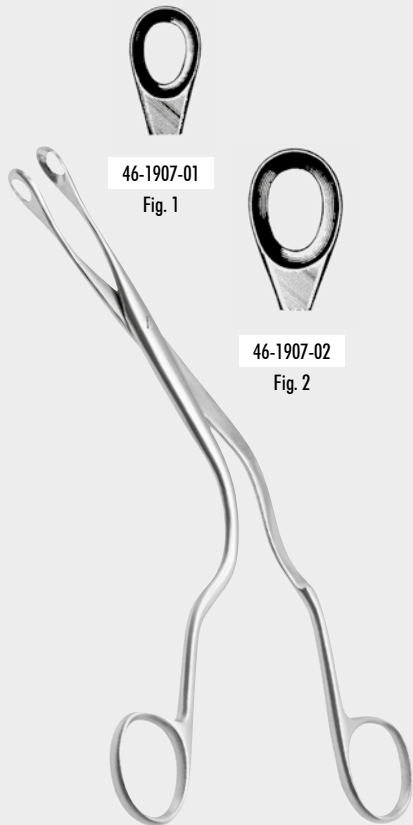

46-1907-01
Fig. 1

46-1907-02
Fig. 2

cm LUC
20,0 46-1907-01 - 46-1907-02



cm IRWIN-MOORE
19,0 46-1909-19



46-1903-01

46.12

ohne Hals
without neck
sans cou
sin cuello
senza collo



46-2201-01
Fig. 1
2,5 mm



46-2201-02
Fig. 2
3,6 mm



46-2201-03
Fig. 3
4,8 mm



46-2201-04
Fig. 4
5,3 mm



46-2201-05
Fig. 5
6,3 mm

mit Hals
with neck
avec cou
con cuello
con collo



46-2203-01
Fig. 1
2,5 mm



46-2203-02
Fig. 2
3,6 mm



46-2203-03
Fig. 3
4,8 mm



46-2203-04
Fig. 4
5,3 mm



46-2203-05
Fig. 5
6,3 mm

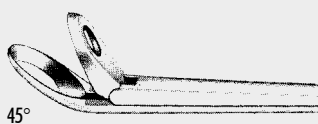

45°



46-2209-02
Fig. 2
3,6 mm



46-2209-03
Fig. 3
4,8 mm



46-2209-04
Fig. 4
5,3 mm

aufwärts schneidend
cutting upward
coupant vers le haut
cortante hacia arriba
tagliante verso il alto

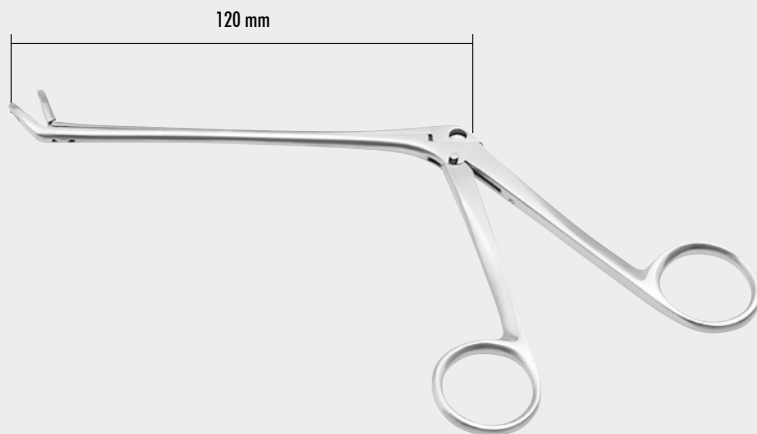

120 mm

Gesamtlänge 19 cm
Overall Length 19 cm
Longueur totale 19 cm
Largo total 19 cm
Lunghezza totale 19 cm

WEIL-BLAKESLEY
46-2201-01 - 46-2209-04



BLAKESLEY WILDE 90°
46-2210-01 2,5 mm
46-2210-02 3,6 mm
46-2210-03 4,8 mm

Scharfe Nasenzangen
Nasal Cutting Forceps
Pinces coupantes pour le nez
Pinzas cortantes para la nariz
Pinze taglianti per il naso

RHINOLOGIE

RHINOLOGY

RHINOLOGIE

RINOLOGÍA

RINOLOGIA



46-2210-03

46.13



Scharfe Nasenzangen
 Nasal Cutting Forceps
 Pincès coupantes pour le nez
 Pinzas cortantes para la nariz
 Pinze taglienti per il naso

RHINOLOGIE

RHINOLOGY

RHINOLOGIE

RINOLOGÍA

RINOLOGIA

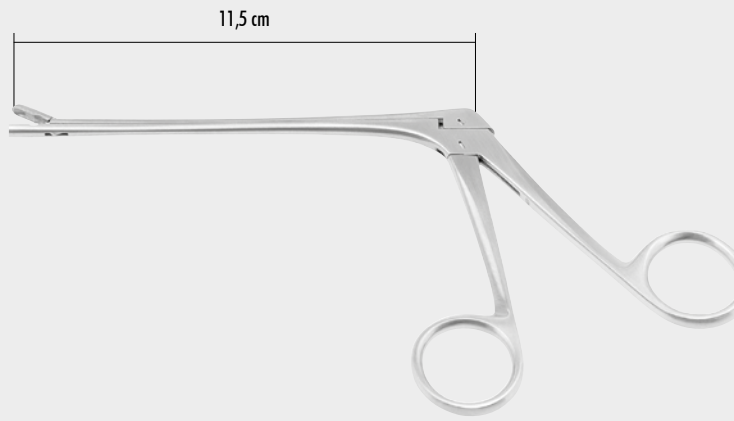

| | |
|-----|-----------------|
| mm | St. BARTHOLOMEW |
| 3,0 | 46-2211-01 |
| | 11,5 cm |

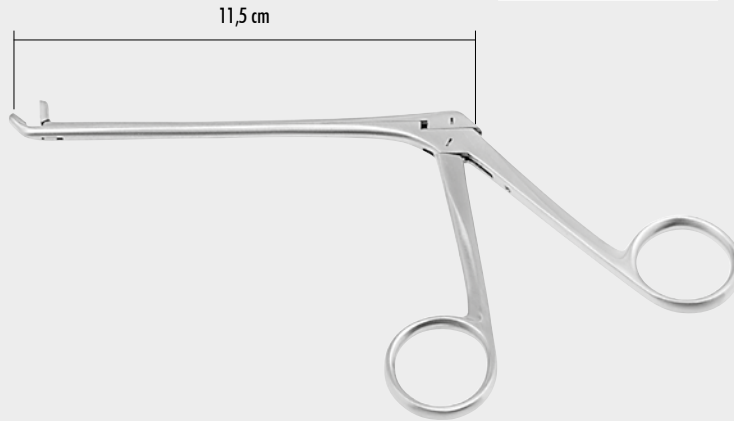

| | |
|-----|-----------------|
| mm | St. BARTHOLOMEW |
| 3,0 | 46-2211-02 |
| | 140° / 11,5 cm |

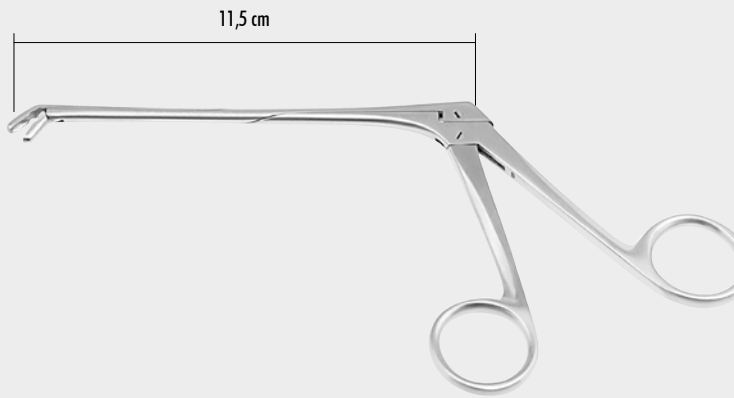

| | |
|-----|-----------------|
| mm | St. BARTHOLOMEW |
| 3,0 | 46-2211-03 |
| | 140° / 11,5 cm |

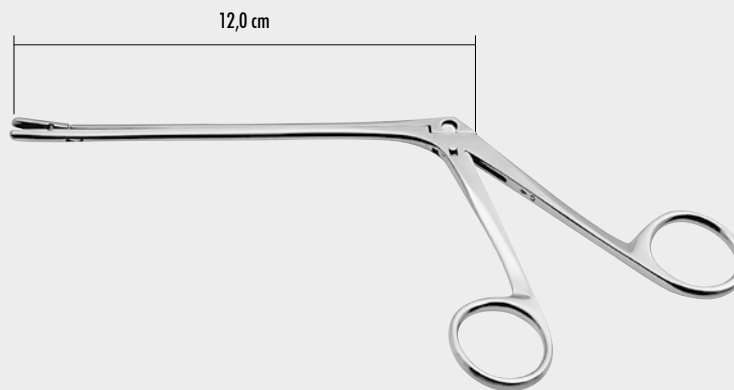

| | | | |
|------|------------|-----------|------------|
| cm | — | TAKAHASHI | — |
| 12,0 | 46-2218-01 | | 46-2218-02 |



46-2211-01

46.14

Scharfe Nasenzangen
 Nasal Cutting Forceps
 Pincès coupantes pour le nez
 Pinzas cortantes para la nariz
 Pinze taglianti per il naso



STRUYCKEN
 46-2301-01
 Fig. 1/0,9 mm

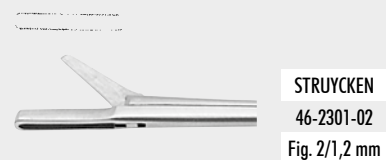

STRUYCKEN
 46-2301-02
 Fig. 2/1,2 mm



46-2307-01
 5 mm



46-2307-02
 7 mm



46-2307-03
 9 mm



46-2305-05



46-2305-07



46-2305-09



46-2305-11



HARTMANN



MYLES
 46-2307-01
 46-2307-02
 46-2307-03



SCHMEDEN
 46-2306-12



cm
 19,0 46-2301-01 - 46-2307-03

RHINOLOGIE

RHINOLOGY

RHINOLOGIE

RINOLOGÍA

RINOLOGIA



46-2307-03

46.15



Mit TC-Einsätzen
TC Lined
A mors TC
Con bocas TC
Con morso TC

Septum-Quetschzangen
Septum Crushing Forceps
Pincés à écraser la cloison
Pinzas para magullar tabique
Pinze per ammaccare il setto

RHINOLOGIE

RHINOLOGY

RHINOLOGIE

RINOLOGÍA

RINOLOGIA



cm
19,5 46-2484-19



cm RUBIN WRIGHT
19,5 46-2490-19



cm RUBIN
21,0 46-2501-21
21,0 46-2502-21



46-2501-99

Schutzkappe allein
Protecting Hood only
Protecteur seul
Protector suelto
Protettore solo

cm KRESSNER
20,0 46-2503-20



46-2484-19

46.16

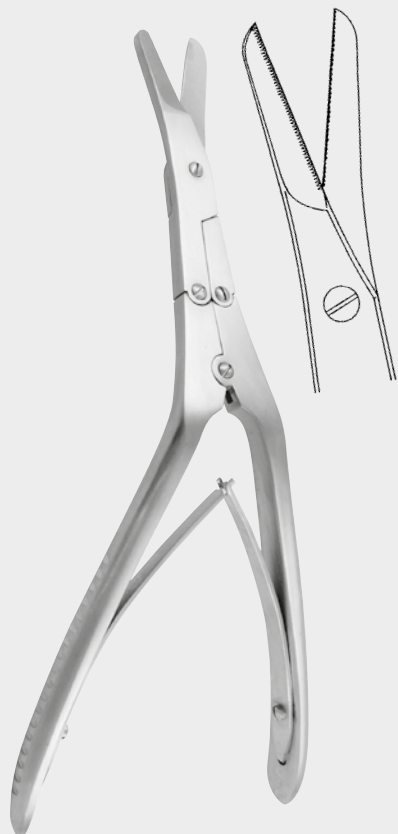

cm CAPLAN
20,0 46-2520-20

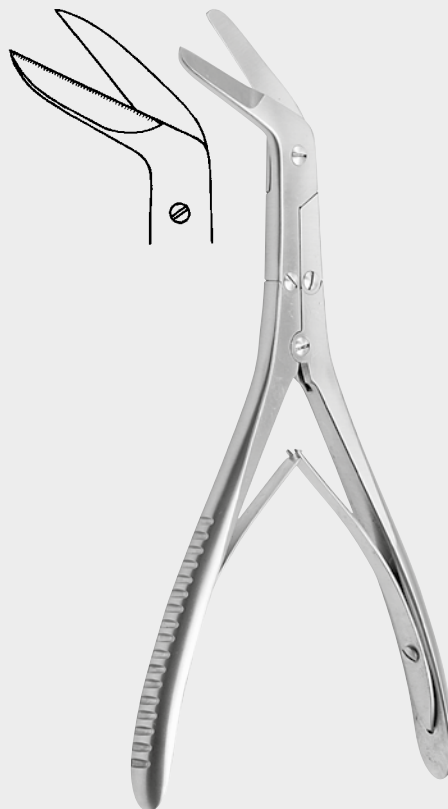

cm KILLIAN
21,0 46-2523-21

Septum-Scheren, Stanzen
Septum Scissors, Punches
Ciseaux à cloison, Pincas emporte-pièces
Tijeras para tabique, pinzas sacabocados
Forbici per setto, pinze taglianti

RHINOLOGIE

RHINOLOGY

RHINOLOGIE

RINOLOGÍA

RINOLOGIA

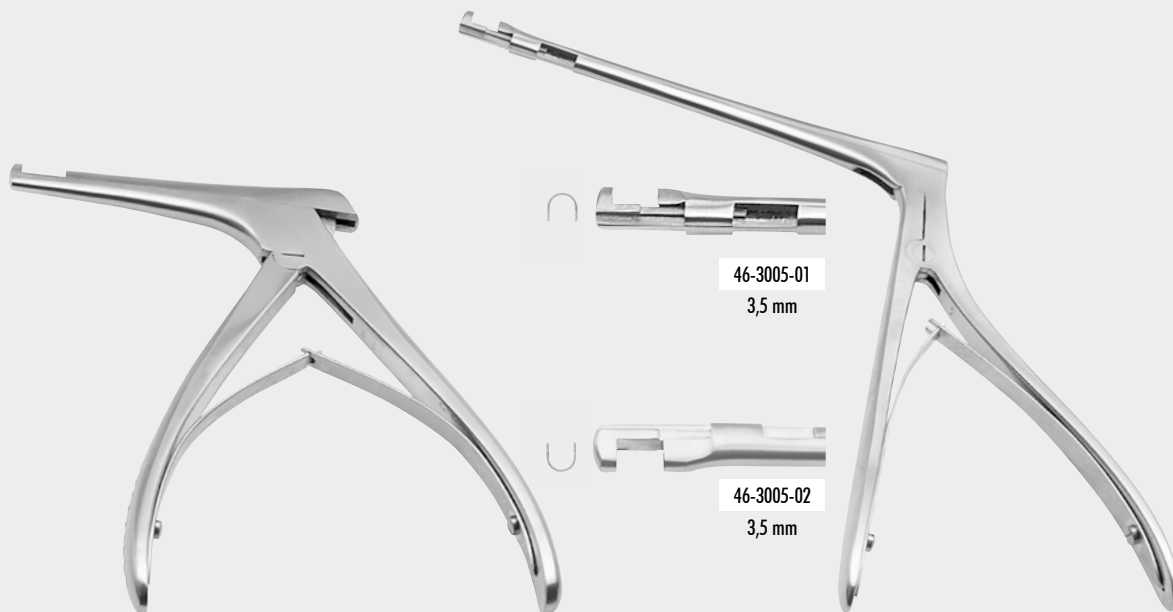

| mm x mm | KERRISON |
|---------|------------|
| 3 x 3 | 46-3003-03 |
| 4 x 4 | 46-3003-04 |
| 5 x 5 | 46-3003-05 |
| 6 x 6 | 46-3003-06 |

17,0 cm

46-3005-01
3,5 mm

46-3005-02
3,5 mm

HAJEK-KOFLER
46-3005-01 - 46-3005-02

ZEPF[®]
α
INSTRUMENTS

46-3005-02

46.17

Septum-Scheren, Stanzen
 Septum Scissors, Punches
 Ciseaux à cloison, Pinces emporte-pièces
 Tijeras para tabique, pinzas sacabocados
 Forbici per setto, pinze taglianti

RHINOLOGIE

RHINOLOGY

RHINOLOGIE

RINOLOGÍA

RINOLOGIA

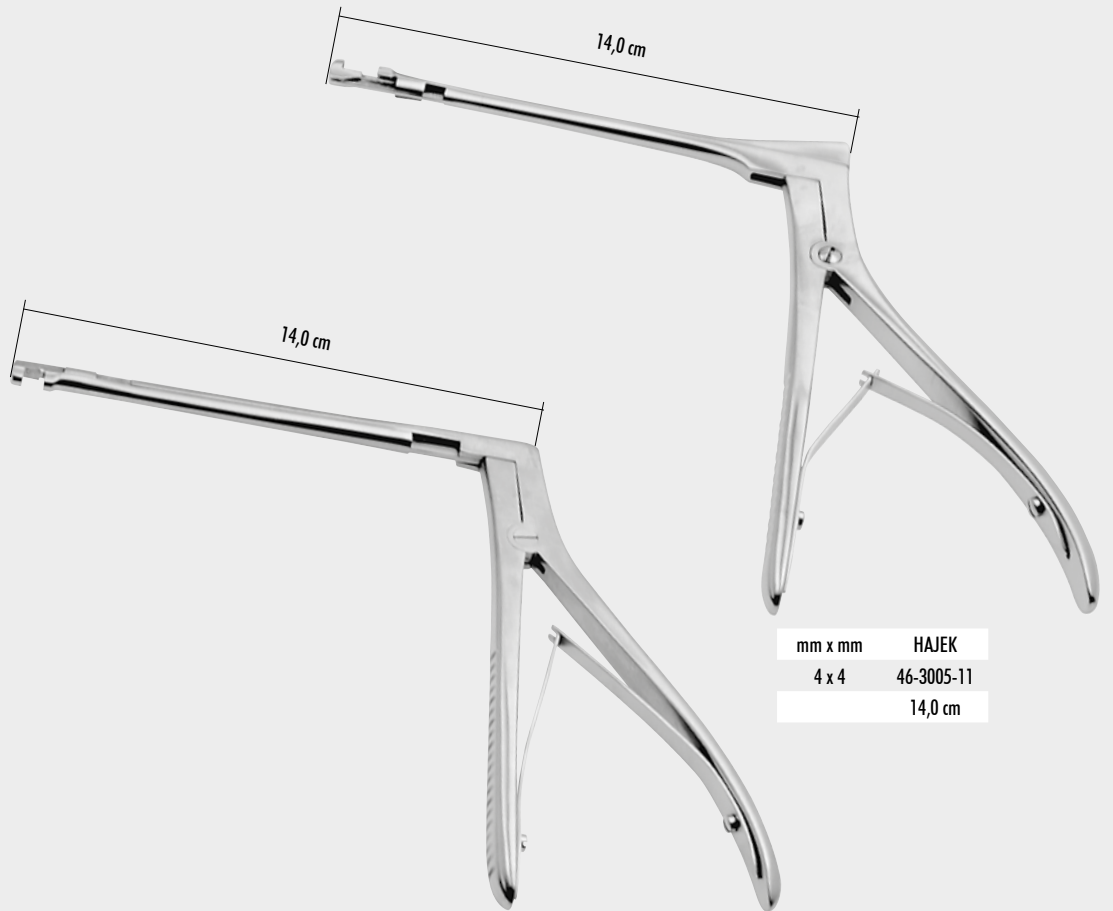

| | |
|---------|------------|
| mm x mm | HAJEK |
| 4 x 4 | 46-3005-11 |
| | 14,0 cm |



| | |
|---------|------------|
| mm x mm | HAJEK |
| 4 x 4 | 46-3005-12 |
| | 14,0 cm |



| | |
|-----|--------------------|
| mm | HAJEK-KOFLER |
| 3,5 | 46-3007-35 |
| | 360 rot. / 17,0 cm |



46-3005-11

46.18

| | |
|-----|--------------------|
| mm | KOFLER |
| 3,0 | 46-3009-30 |
| | 360 rot. / 15,0 cm |



| | |
|-----|------------|
| mm | HAJEK |
| 4,0 | 46-3011-40 |
| | 14,0 cm |



| | |
|-----|------------|
| mm | HAJEK |
| 4,0 | 46-3013-40 |
| | 14,0 cm |

Septum-Scheren, Stanzen
 Septum Scissors, Punches
 Ciseaux à cloison, Pinces emporte-pièces
 Tijeras para tabique, pinzas sacabocados
 Forbici per setto, pinze taglianti

RHINOLOGIE

RHINOLOGY

RHINOLOGIE

RINOLOGÍA

RINOLOGIA

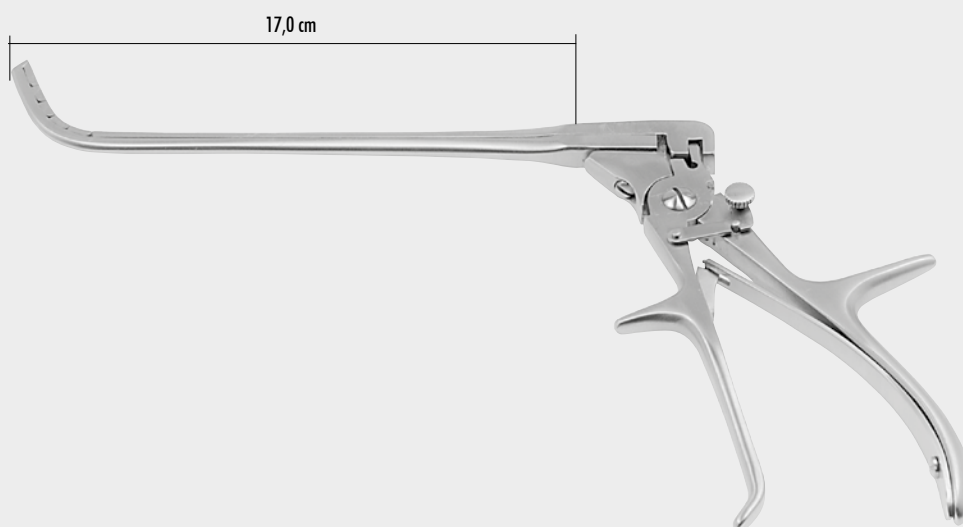

| | |
|-----|------------|
| mm | 40° |
| 2,0 | 46-3021-17 |
| | 17,0 cm |



| | |
|-----|------------|
| mm | CITELLI |
| 1,0 | 46-3101-10 |
| 2,5 | 46-3101-25 |
| 4,0 | 46-3101-40 |

ZEPF[®]
α
 INSTRUMENTS

46-3101-40

46.19

Stanzen
 Punches
 Pincas emporte-pièces
 Pinzas sacabocados
 Pinze taglianti

RHINOLOGIE

RHINOLOGY

RHINOLOGIE

RINOLOGÍA

RINOLOGIA



mm BEYER
 2,0 46-3105-20



cm HAJEK-CLAUS
 20,0 46-3200-20



cm MIDDLETON-JANSEN
 19,0 46-3203-19



cm MIDDLETON-JANSEN
 19,0 46-3205-19



cm JANSEN STRUYCKEN
 19,0 46-3207-19



| mm | LICHTWITZ 10,0 cm |
|-----|-------------------|
| 1,0 | 46-3400-10 |
| 1,5 | 46-3400-15 |
| 1,8 | 46-3400-18 |
| 2,0 | 46-3400-20 |

Luer Lock



| ø mm | KILLIAN |
|------|------------|
| 3,0 | 46-3401-03 |
| | 14,0 cm |



| ø mm | EICKEN KILLIAN |
|------|----------------|
| 3,0 | 46-3403-03 |
| | 14,0 cm |



| cm | KRAUSE |
|------|------------|
| 26,0 | 46-3501-26 |



| cm | WILDE |
|------|------------|
| 24,0 | 46-3502-24 |

RHINOLOGIE

RHINOLOGY

RHINOLOGIE

RINOLOGÍA

RINOLOGIA

12 Stück
12 ea.
12 pcs.
12 pzs.
12 pezzi



| |
|------------|
| 46-3505-03 |
| ø 0,3 mm |



| |
|----------------------|
| JOSEPH |
| 46-3700-16 - 3703-16 |



| | |
|------------|------------|
| 46-3700-16 | 46-3701-16 |
|------------|------------|



| | |
|------------|------------|
| 46-3702-16 | 46-3703-16 |
|------------|------------|



Nasenmesser
Nasal Knives
Bistouris nasaux
Bisturías nasales
Coltelli nasali



46-3703-16

46.21

Nasenmesser
 Nasal Knives
 Bistouris nasaux
 Bisturías nasales
 Coltelli nasali

RHINOLOGIE

RHINOLOGY

RHINOLOGIE

RINOLOGÍA

RINOLOGIA



cm FREER
 15,0 46-3704-15



cm FREER
 19,0 46-3705-19



cm JOSEPH
 16,0 46-3706-16

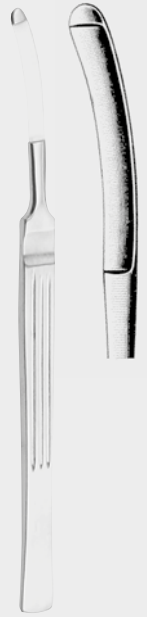

cm CONVERSE
 16,0 46-3709-16



cm COTTLE
 14,0 46-3798-14



cm COTTLE
 15,0 46-3800-15



cm COTTLE
 15,0 46-3802-15



cm COTTLE
 15,0 46-3804-15



cm COTTLE
 15,0 46-3805-15

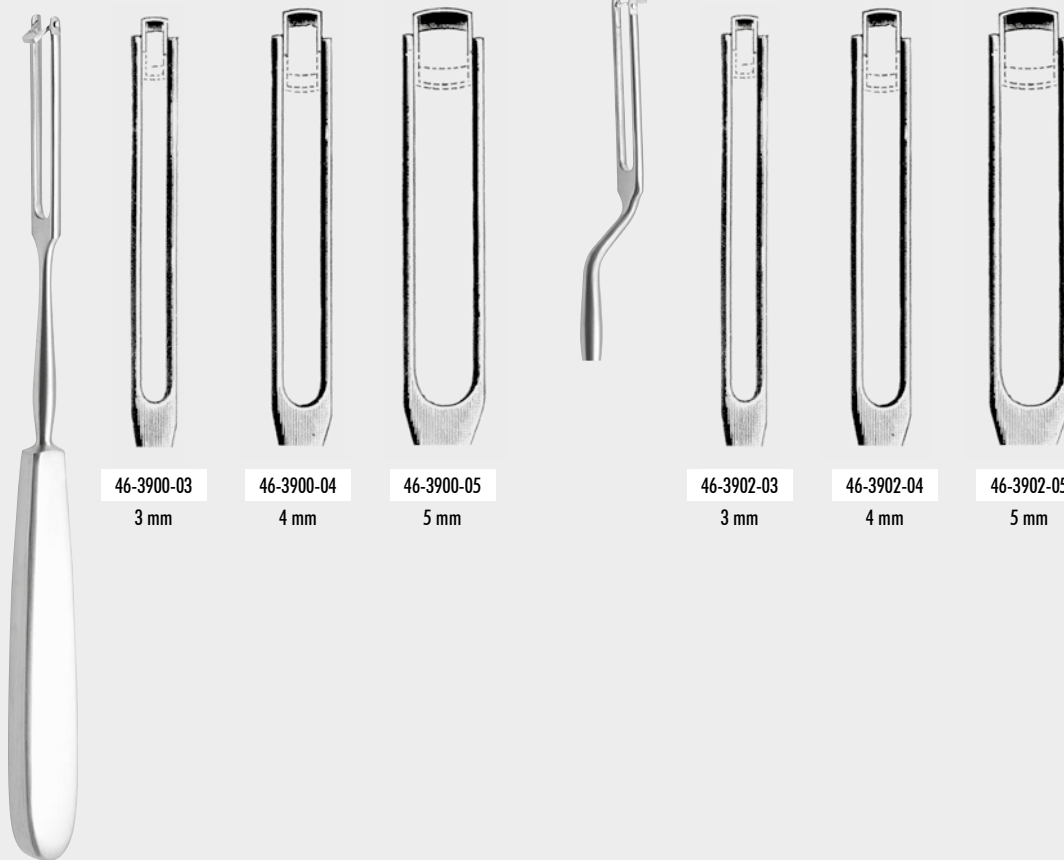

46-3900-03
3 mm

46-3900-04
4 mm

46-3900-05
5 mm

46-3902-03
3 mm

46-3902-04
4 mm

46-3902-05
5 mm

cm **BALLENGER**
20,0 46-3900-03 - 46-3902-05

Septum-Schwingmesser
Septum Swivel Knives
Couteaux mobiles pour la cloison
Cuchillos para tabique con hojas movibles
Coltelli a lama girevole per il setto

RHINOLOGIE

RHINOLOGY

RHINOLOGIE

RINOLOGÍA

RINOLOGIA

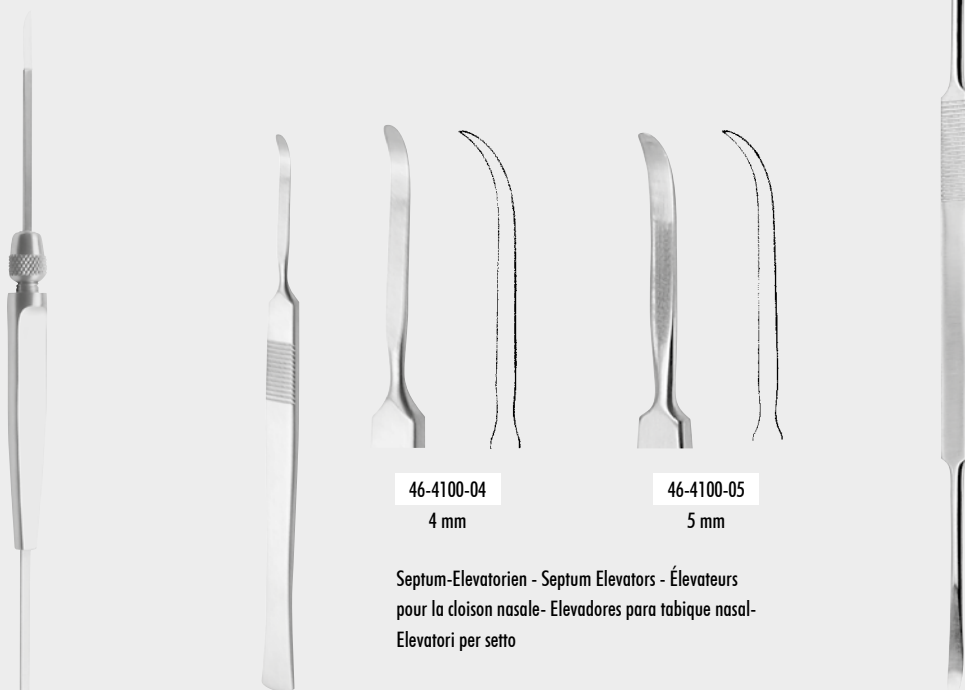

46-4100-04
4 mm

46-4100-05
5 mm

Septum-Elevatorien - Septum Elevators - Éleveurs
pour la cloison nasale- Elevadores para tabique nasal-
Elevatori per setto

cm **BRUENINGS**
16,5 46-3908-16

cm **McKENTY**
15,0 46-4100-04 - 46-4100-05

cm **Mc KENTY**
22,0 46-4101-22

Septum-Messer - Septum
Knife - Bistouri à cloison -
Bisturí para tabique nasal
Coltello per il setto nasale



46-4101-22

46.23



Septum-Elevatorien
 Septum Elevators
 Élévateurs pour la cloison nasale
 Elevadores para tabique nasal
 Elevatori per il setto

RHINOLOGIE

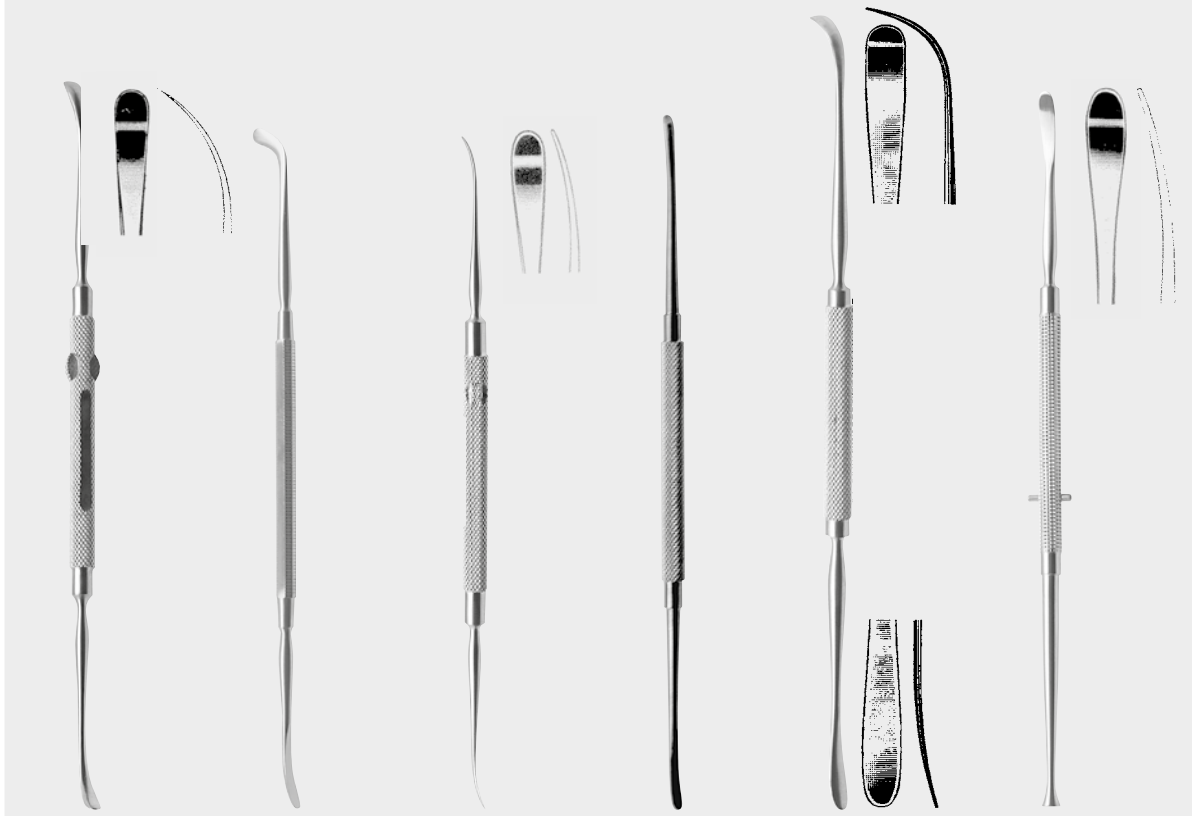

| | | | | | | | | | | | |
|------|--------------|------|------------|--------------|------------|--------------|----------------|------|------------|------|------------|
| cm | ROGER | cm | FREER | cm | FREER | cm | FREER YASARGIL | cm | FREER | cm | FREER |
| 19,0 | 46-4103-19 | 17,5 | 46-4104-18 | 18,0 | 46-4105-18 | 18,5 | 46-4106-18 | 20,0 | 46-4106-20 | 19,0 | 46-4107-19 |
| | 4,5 x 4,5 mm | | | 4,5 x 4,5 mm | | 3,0 x 3,0 mm | | | | | |

RHINOLOGY

RHINOLOGIE

RINOLOGÍA

RINOLOGIA

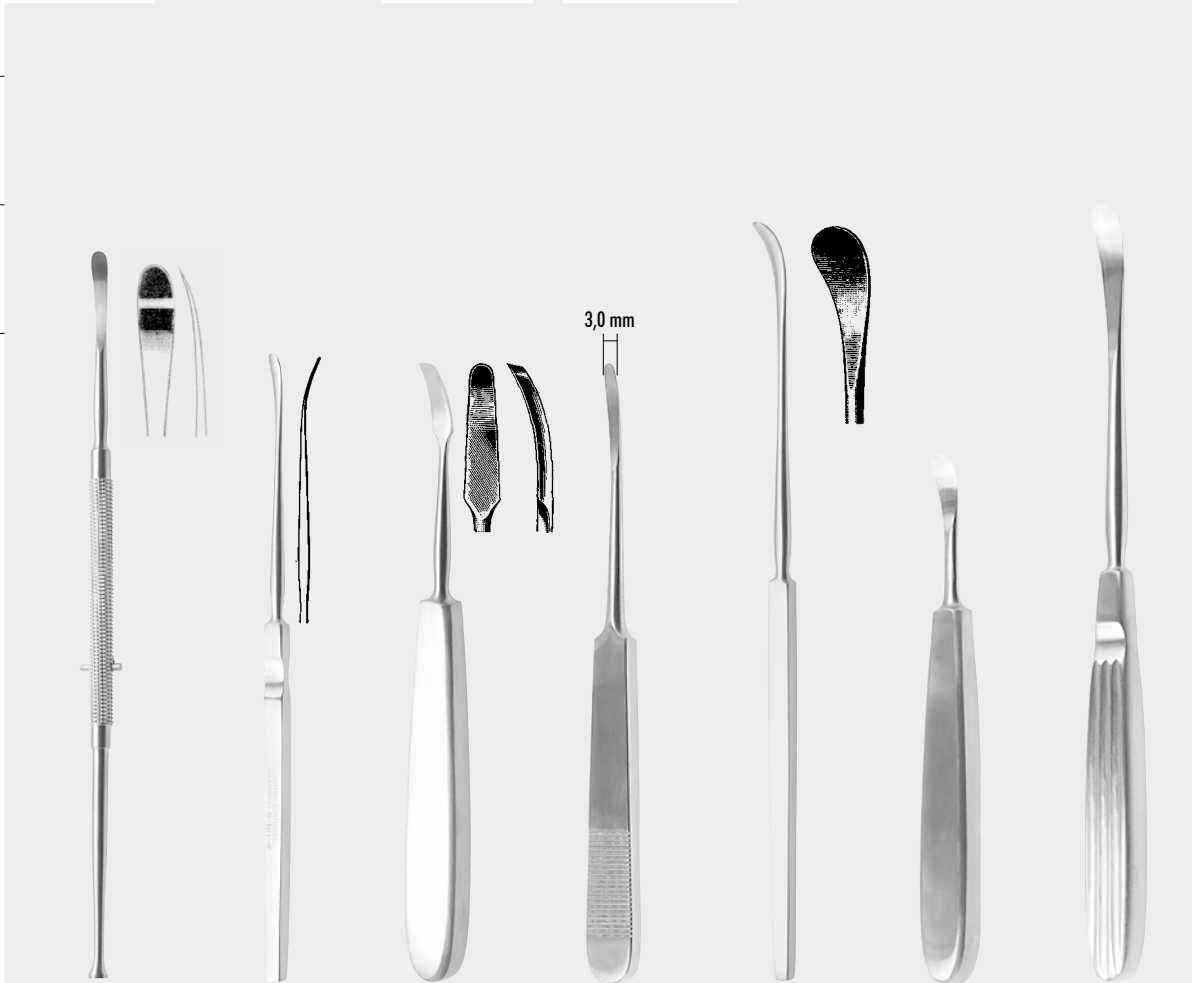

| | | | | | | | | | | | | |
|------|------------|--------|------------|--------------|------------|------------|------|------------|------|------------|------|------------|
| cm | FREER | cm | HALLE | cm | JOSEPH | SEWALL | cm | SEWALL | cm | TRELAT | cm | COTTLE |
| 19,0 | 46-4109-19 | 16,5 | 46-4111-16 | 16,0 | 46-4113-16 | 46-4114-01 | 20,0 | 46-4115-20 | 14,5 | 46-4117-14 | 19,5 | 46-4119-19 |
| | | 4,0 mm | | 4,0 x 6,0 mm | 46-4114-02 | 6,0 mm | | | | | | |
| | | | | | 16,0 cm | | | | | | | |



46-4103-19

46.24

Septum-Elevatorien
 Septum Elevators
 Élévateurs pour la cloison nasale
 Elevadores para tabique nasal
 Elevatori per il setto

RHINOLOGIE

RHINOLOGY

RHINOLOGIE

RINOLOGÍA

RINOLOGIA

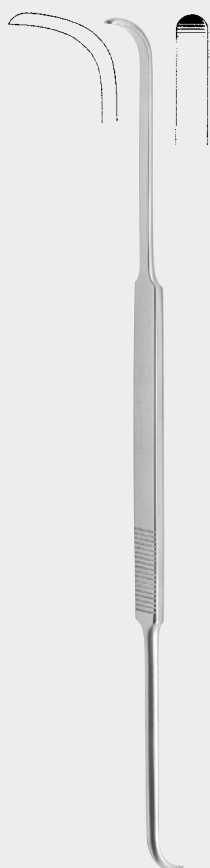

cm COTTLE
 23,0 46-4201-23
 4,0 x 4,0 mm



cm COTTLE
 22,0 46-4203-22
 3,5 x 4,0 mm



cm COTTLE
 22,0 46-4204-22



cm JOSEPH
 16,0 46-4205-16
 6,0 mm

ZEPF[®]

 INSTRUMENTS

46-4205-16

46.25

Elevatorien, Raspatorien, Nasenmeissel
 Elevators, Raspatories, Nasal Chisels
 Élévateurs, rugines, ciseaux nasaux
 Elevadores, periostótomos, cínceles
 Elevatori, periostotomi, cesoie

RHINOLOGIE

RHINOLOGY

RHINOLOGIE

RINOLOGÍA

RINOLOGIA



cm COTTLE
 19,0 46-4205-19

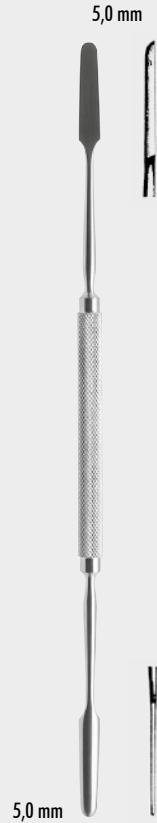

cm KILLIAN
 22,0 46-4206-22

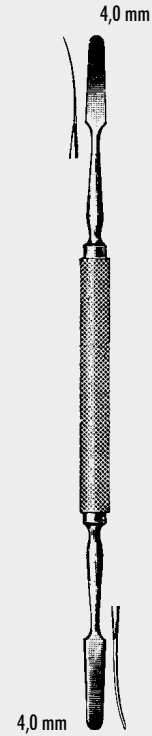

cm KILLIAN
 18,0 46-4207-18



cm HAJEK-BALLENGER
 19,0 46-4208-19
 22,0 46-4208-21



cm PIERCE
 21,5 46-4209-21



cm HILL
 22,0 46-4210-22



cm JOSEPH MASING (COTTLE-MASING)
 22,0 46-4211-22

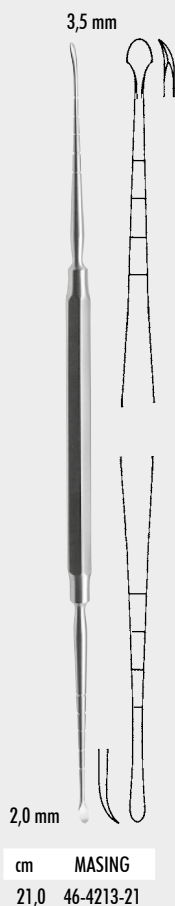

2,0 mm
cm MASING
21,0 46-4213-21



cm CARTER
21,0 46-4217-21



4,0 mm
cm BALLENGER
22,0 46-4300-22

Elevatori, Raspatorii, Nasenmeissel
Elevators, Raspatories, Nasal Chisels
Élévateurs, rugines, ciseaux nasaux
Elevadores, periostótomos, cinceles
Elevatori, periostotomi, cesoie

RHINOLOGIE

RHINOLOGY

RHINOLOGIE

RINOLOGÍA

RINOLOGIA



mm FREER 19,0 cm
4,0 46-4498-19 46-4499-19

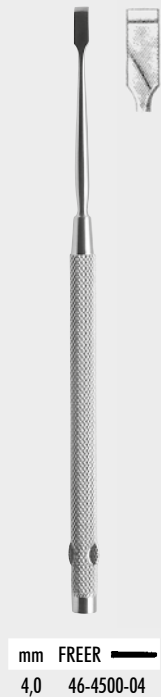

mm FREER
4,0 46-4500-04

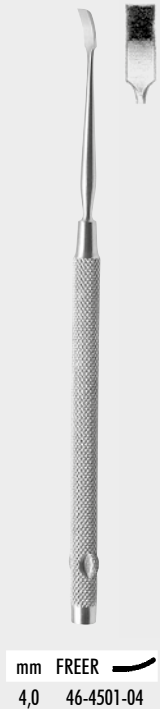

mm FREER
4,0 46-4501-04



Elevatorii, Raspatorii, Nasenmeissel
 Elevators, Raspatories, Nasal Chisels
 Élévateurs, rugines, ciseaux nasaux
 Elevadores, periostótomos, cínceles
 Elevatori, periostotomi, cesoie

RHINOLOGIE

RHINOLOGY

RHINOLOGIE

RINOLOGÍA

RINOLOGIA



| mm | SHEEHAN |
|------|------------|
| 1,0 | 46-4502-01 |
| 2,0 | 46-4502-02 |
| 3,0 | 46-4502-03 |
| 4,0 | 46-4502-04 |
| 5,0 | 46-4502-05 |
| 6,0 | 46-4502-06 |
| 7,0 | 46-4502-07 |
| 8,0 | 46-4502-08 |
| 10,0 | 46-4502-10 |
| 12,0 | 46-4502-12 |

| cm | COTTLE |
|------|-------------------------|
| 18,0 | 46-4504-04 - 46-5404-12 |



- 46-4504-04
4,0 mm
- 46-4504-06
6,0 mm
- 46-4504-07
7,0 mm
- 46-4504-08
8,0 mm
- 46-4504-09
9,0 mm
- 46-4504-10
10,0 mm
- 46-4504-12
12,0 mm

| cm | COTTLE | mm |
|------|------------|-----|
| 18,0 | 46-4505-04 | 4,0 |
| 18,0 | 46-4505-06 | 6,0 |



| cm | COTTLE |
|------|-------------------------|
| 18,0 | 46-4508-04 - 46-4508-12 |

- 46-4508-04
4,0 mm
- 46-4508-07
7,0 mm
- 46-4508-09
9,0 mm
- 46-4508-12
12,0 mm



| cm | COTTLE |
|------|-------------------------|
| 18,0 | 46-4600-04 - 46-4600-12 |

- 46-4600-04
4,0 mm
- 46-4600-07
7,0 mm
- 46-4600-12
12,0 mm



| mm | RUBIN |
|------|------------|
| 10,0 | 46-4602-10 |
| 12,0 | 46-4602-12 |
| 14,0 | 46-4602-14 |
| 18,5 | |



| mm | WALTER |
|------|------------|
| 3,0 | 46-4610-03 |
| 4,0 | 46-4610-04 |
| 7,0 | 46-4610-07 |
| 9,0 | 46-4610-09 |
| 12,0 | 46-4610-12 |
| 19,0 | |



| mm | WALTER |
|------|------------|
| 3,0 | 46-4611-03 |
| 4,5 | 46-4611-04 |
| 19,0 | |



46-4502-01

46.28



cm **PARKES**
16,0 46-4620-01



cm **FOMON**
17,0 46-4700-04 - 46-4700-08



46-4700-04
4,0 mm



46-4700-05
5,0 mm



46-4700-06
6,0 mm



46-4700-07
7,0 mm



46-4700-08
8,0 mm

Elevatori, Raspatorii, Nasenmeissel
Elevators, Raspatories, Nasal Chisels
Élévateurs, rugines, ciseaux nasaux
Elevadores, periostótomos, cinceles
Elevatori, periostotomi, cesoie

RHINOLOGIE

RHINOLOGY

RHINOLOGIE

RINOLOGÍA

RINOLOGIA



CINELLI
46-4702-10 - 46-4702-16



46-4702-10
10,0 mm



46-4702-12
12,0 mm

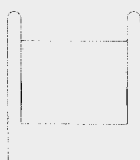

46-4702-14
14,0 mm



46-4702-16
16,0 mm

Nasenplastik-Meissel
Rhinoplastic Chisels
Ciseaux-burins pour la rhinoplastie
Cinceles para la rinoplastia
Cesoie per rinoplastica

ZEPF®
α
INSTRUMENTS

46-4702-16

46.29



gerade
straight
droit
recto
diritto

Nasenplastik-Meissel
Rhinoplastic Chisels
Ciseaux-burins pour la rhinoplastie
Cinceles para la rinoplastia
Cesoie per rinoplastica

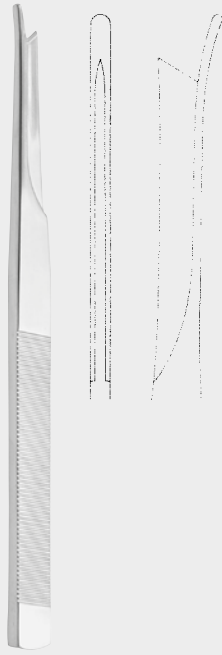

cm SILVER
18,0 46-4703-01



cm SILVER »
18,0 46-4703-02

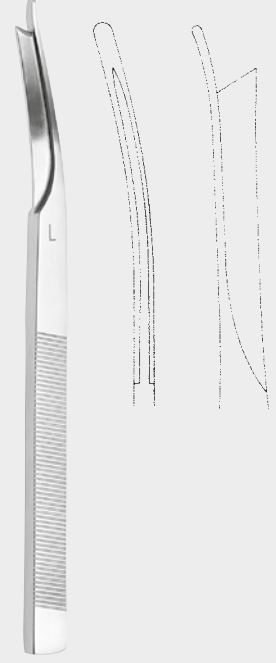

cm SILVER «
18,0 46-4703-03

RHINOLOGIE

RHINOLOGY

RHINOLOGIE

RINOLOGÍA

RINOLOGIA



mm NEIVERT ANDERSON
7,0 46-4705-01
20,0 cm



mm NEIVERT ANDERSON «
7,0 46-4705-02
20,0 cm



mm NEIVERT ANDERSON »
7,0 46-4705-03
20,0 cm



46-4703-01

46.30



cm CONVERSE
19,0 46-4707-01



cm CONVERSE «
19,0 46-4707-02



cm CONVERSE »
19,0 46-4707-03

Nasenplastik-Meissel
Rhinoplastic Chisels
Ciseaux-burins pour la rhinoplastie
Cinceles para la rinoplastia
Cesoie per rinoplastica

RHINOLOGIE

RHINOLOGY

RHINOLOGIE

RINOLOGÍA

RINOLOGIA



mm GUY
5 46-4801-13
13,0 cm



mm KILLIAN-CLAUS
5 46-4802-05
17,0 cm



KILLIAN
46-4803-05
16,0 cm



mm HAJEK
4 46-4804-04
6 46-4804-06
8 46-4804-08



mm MC INDOE
9 46-4805-09
10 46-4805-10
11 46-4805-11
15 46-4805-15

Nasenmeissel
Nasal Chisels and Gouges
Ciseaux-burins et gouges nasaux
Cinceles y gubias nasales
Cesoie e sgorbie nasali



46-4805-15

46.31

Nasenmeißel
 Nasal Chisels and Gouges
 Ciseaux-burins et gouges nasaux
 Cinceles y gubias nasales
 Česoië e sgorbie nasali

RHINOLOGIE

RHINOLOGY

RHINOLOGIE

RINOLOGÍA

RINOLOGIA

Knochenfeile, Nasenraspeln
 Bone File, Nasal Rasps
 Lime à os, râpes nasales
 Lima para huesos, escofinas nasales
 Lima per ossa, raspe nasali



cm WEST
 16,0 46-4806-16



cm WEST
 16,0 46-4807-16



cm FREER
 16,0 46-4809-16

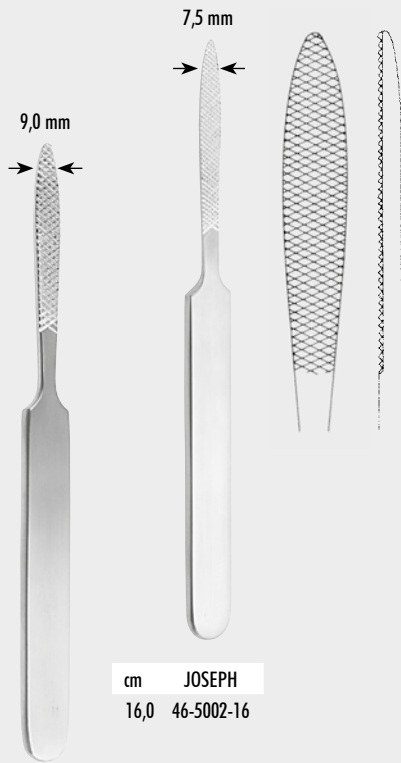

cm JOSEPH
 16,0 46-5002-16

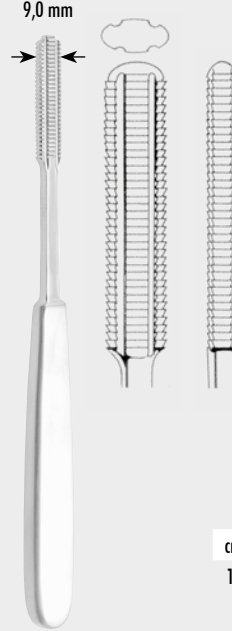

cm MALTZ (AUFRICHT)
 18,0 46-5004-18

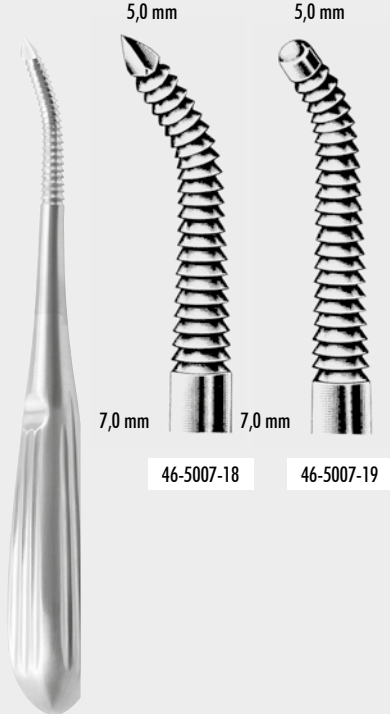

46-5007-18

46-5007-19

cm JOSEPH
 16,5 46-5000-16

cm WIENER (American)
 18,0 46-5007-18 - 46-5007-19



46-4806-16

46.32



cm AUFRICHT
21,0 46-5101-21 - 46-5103-21

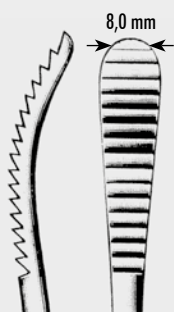

46-5101-21

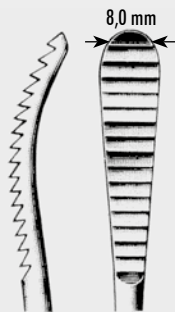

46-5103-21



cm MALTZ (COTTLE)
21,0 46-5108-21

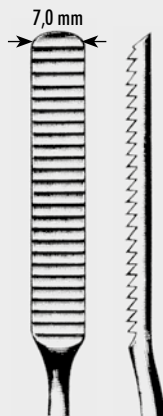

cm JOSEPH (LEWIS)
18,0 46-5104-16 - 46-5106-16

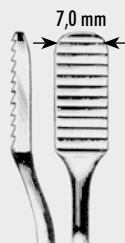

46-5104-16
fein - fine - fina

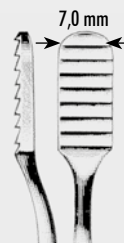

46-5106-16
grob - coarse - dentelure grosse
gruesa - dentellatura grossa



cm MALTZ —
18,0 46-5110-18



cm MALTZ —
18,0 46-5111-18



7,0 mm
cm FOMON
21,5 46-5198-21
6,5 mm / 7,5 mm



7,0 mm
cm FOMON
21,0 46-5200-21

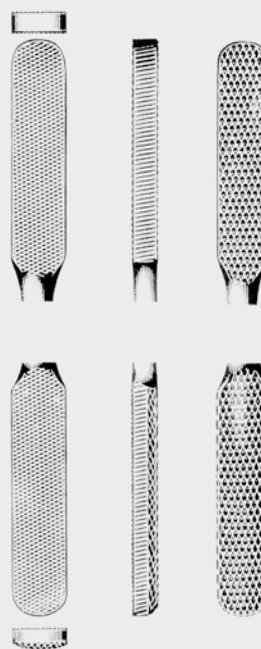

Nasenraspeln
Nasal Rasps
Râpes nasales
Escofinas nasales
Raspe nasali

RHINOLOGIE

RHINOLOGY

RHINOLOGIE

RINOLOGÍA

RINOLOGIA



Nasenraspeln
Nasal Rasps
Râpes nasales
Escofinas nasales
Raspe nasali

RHINOLOGIE

RHINOLOGY

RHINOLOGIE

RINOLOGÍA

RINOLOGIA

Mit TC-Einsätzen
TC Lined
A mors TC
Con bocas TC
Con morso TC

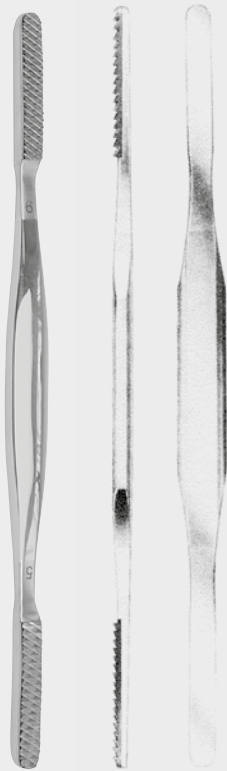

cm FOMON TC
20,0 46-5202-01 - 46-5202-09



46-5202-01
Fig. 1/2



46-5202-03
Fig. 3/4



46-5202-05
Fig. 5/6



46-5202-07
Fig. 7/8



46-5202-09
Fig. 9/10



46-5206-16
Fig. 1

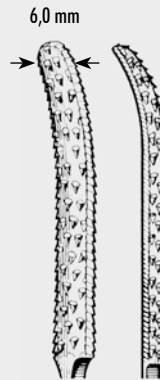

46-5207-16
Fig. 2

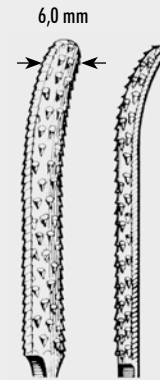

46-5209-16
Fig. 3



GALLAHER
46-5206-16 - 46-5209-16



46-5202-01
46.34



46-5301-19

46-5302-19 «

46-5304-19 »

gerade
straight
droite
recta
diritta

cm JOSEPH
19,0 46-5301-19 - 46-5304-19



« JOSEPH »
46-5305-01 17,0 cm 46-5305-02

Nasenraspeln
Nasal Rasps
Râpes nasales
Escofinas nasales
Raspe nasali

RHINOLOGIE

RHINOLOGY

RHINOLOGIE

RINOLOGÍA

RINOLOGIA



COTTLE
46-5320-00

Quetscher mit Entnahmeklammer
Cartilage Crusher with Clamp
Presse pour matière cartilagineuse avec pince
Instrumento para magullar cartilago con pinza
Prensa tritacartilagine con pinza

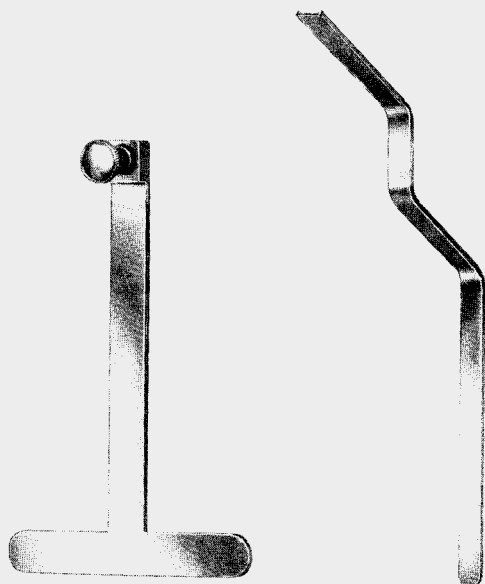

COTTLE
46-5321-00

Einführungsinstrument
Applicator
Introduceur de matière cartilagineuse
Introdutor de cartilago
Strumento per applicazione



ø mm KING
20,0 46-5330-13
13,0 cm

mit Kaltlicht
with fibre light
à lumière froide
con luz fría
con luce fredda

Nasenhaken
Nasal Retractors
Écarteurs nasaux
Separadores nasales
Divaricatori nasali

RHINOLOGIE



cm AUFRIEHT
16,0 46-5501-19



cm AUFRIEHT
16,0 46-5502-16



cm Mc INDOE
15,0 46-5503-09



cm Mc INDOE
15,0 46-5503-10



cm BARSKY
15,0 46-5505-15

RHINOLOGY

RHINOLOGIE

RINOLOGÍA

RINOLOGIA



cm COTTLE
14,0 46-5506-13



cm COTTLE
14,0 46-5506-14



cm
14,0 46-5506-15



FOMON
46-5506-16



FOMON
46-5507-17

Nasenhaken
Nasal Retractors
Écarteurs nasaux
Separadores nasales
Divaricatori nasali



cm LANGE
22,0 46-5507-22



cm MÜLLER
15,0 46-5508-01



cm MÜLLER
15,0 46-5508-02

RHINOLOGIE

RHINOLOGY

RHINOLOGIE

RINOLOGÍA

RINOLOGIA



COTTLE-NEIVERT
46-5509-20



cm HUMBY
11,5 46-5510-11



cm FREER
15,0 46-5511-15



| mm x mm | CONVERSE |
|-----------|------------|
| 18 x 9,5 | 46-5512-18 |
| 28 x 12,5 | 46-5512-28 |
| 41 x 13,5 | 46-5512-41 |
| 53 x 13,5 | 46-5512-53 |
| | 9,0 cm |

ZEPF®
INSTRUMENTS

46-5512-53

46.37

Nasenhaken
 Nasal Retractors
 Écarteurs nasaux
 Separadores nasales
 Divaricatori nasali

RHINOLOGIE



| | |
|-------------|------------|
| mm | CONVERSE |
| 44,0 x 11,0 | 46-5513-11 |
| | 10,5 cm |



| | |
|------|------------|
| cm | KILNER |
| 10,0 | 46-5514-10 |
| 12,0 | 46-5514-12 |



| | |
|------|------------|
| cm | CONVERSE |
| 12,0 | 46-5516-12 |



| | |
|------|------------|
| cm | COTTLE |
| 14,0 | 46-5517-14 |

RHINOLOGY

RHINOLOGIE

RINOLOGÍA

RINOLOGIA



| | |
|------|------------|
| cm | NEIVERT |
| 16,0 | 46-5519-16 |



| | |
|------|------------|
| cm | COTTLE |
| 15,0 | 46-5521-15 |



| | |
|------|------------|
| cm | COTTLE |
| 15,0 | 46-5523-15 |



| | |
|------|------------|
| cm | AUFRICHT |
| 13,5 | 46-5525-14 |



| | |
|------|------------|
| cm | WALTER |
| 13,5 | 46-5529-13 |



46-5513-11

46.38



Fig. 1



Fig. 2



cm COTTLE
14,5 46-5604-01



cm COTTLE
14,5 46-5604-02



cm COTTLE
17,0 46-5606-17



cm COTTLE
16,0 46-5608-16

| Fig. | cm | GILLIES |
|------|------|------------|
| 1 | 18,0 | 46-5600-18 |
| 1 | 23,0 | 46-5600-23 |
| 2 | 18,0 | 46-5602-18 |

Septum-Richtzangen
Septum Straightening Forceps
Pincès à redresser la cloison
Pinzas para enderezar tabique
Pinze per raddrizzare il setto

RHINOLOGIE

RHINOLOGY

RHINOLOGIE

RINOLOGÍA

RINOLOGIA



cm ASCH
23,0 46-5701-23



cm WALSHAM
23,0 46-5702-23 - 46-5705-23



46-5702-23



46-5703-23

«



46-5705-23

»



46-5705-23

46.39

RHINOLOGIE

RHINOLOGY

RHINOLOGIE

RINOLOGÍA

RINOLOGIA

Küretten, scharf
Curettes, sharp
Curettes tranchantes
Curetas cortantes
Curette taglienti

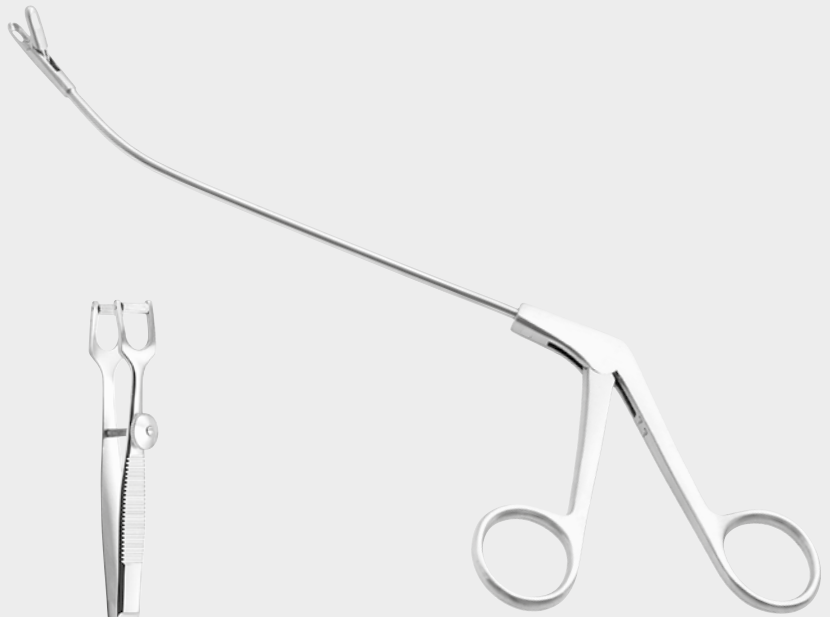

JATHO
46-5905-15

Nasensrachenzange, scharf
Nasopharyngeal Forceps, Sharp
Pince nasopharyngienne, tranchante
Pinza nasofaringea, cortante
Pinza nasofaringea, tagliente



cm COTTLE
14,0 46-5802-14

Haut-Fasspinzette
Skin Grasping Forceps
Pince à saisir la peau
Pinza para agarrar la piel
Pinza per afferrare pelle



cm COTTLE
10,0 46-5804-10

Columella Klemme
Columella Clamp
Pince à columelle
Pinza para columela
Pinza per columella



cm MACKAY
21,0 46-5990-21



cm MACKAY
21,0 46-5992-21



cm FAULKNER
21,0 46-6001-21



cm PRATT
21,0 46-6003-21



cm COAKLEY
17,0 46-6007-01 - 46-6007-06



46-6007-01
Fig. 1

46-6007-02
Fig. 2

46-6007-03
Fig. 3

46-6007-04
Fig. 4

46-6007-05
Fig. 5

46-6007-06
Fig. 6



46-6200-01
46-6201-01
Fig. 1



46-6200-02
46-6201-02
Fig. 2



46-6200-03
46-6201-03
Fig. 3



46-6200-04
46-6201-04
Fig. 4



46-6200-05
46-6201-05
Fig. 5



46-6200-06
46-6201-06
Fig. 6

cm BECKMANN
22,0 46-6200-01 - 46-6200-06

cm BECKMANN
22,5 46-6201-01 - 46-6201-06

Ringmesser
Adenoid Currettes
Curettes à végétations adénoïdes
Cuchillos para vegetaciones adenoides
Coltelli per vegetazioni adenoidee

RHINOLOGIE

RHINOLOGY

RHINOLOGIE

RINOLOGÍA

RINOLOGIA

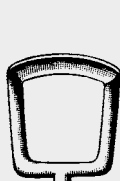

46-6220-01
Fig. 1

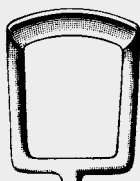

46-6220-04
Fig. 4

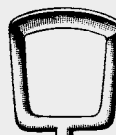

46-6222-01
Fig. 1

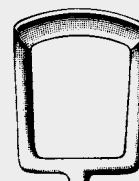

46-6222-04
Fig. 4

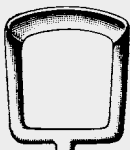

46-6220-02
Fig. 2

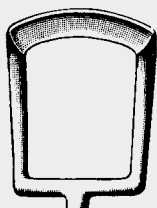

46-6220-05
Fig. 5

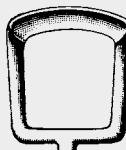

46-6222-02
Fig. 2

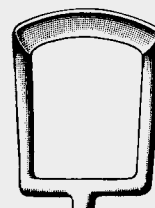

46-6222-05
Fig. 5

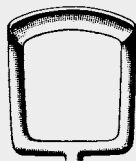

46-6220-03
Fig. 3

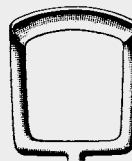

46-6222-03
Fig. 3

cm BECKMANN
22,0 46-6220-01 - 46-6220-05

cm BECKMANN
22,0 46-6222-01 - 46-6222-05

trapezförmig gefenstert
trapezoidal fenestration
fenêtrées trapézoïdalement
fenestrados trapezoidalmente
fenestrati a forma di trapezio



46-6402-01

46.41



Ringmesser
Adenoid Curettes
Curettes à végétations adénoïdes
Cuchillos para vegetaciones adenoideas
Coltelli per vegetazioni adenoidee

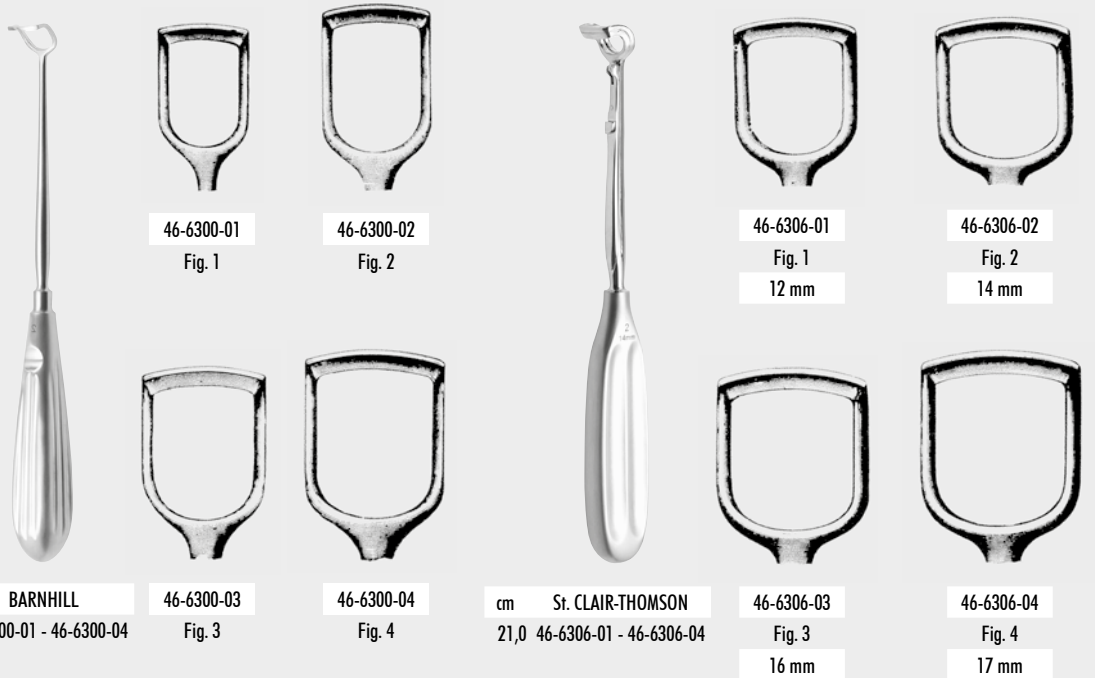

RHINOLOGIE

cm BARNHILL
21,0 46-6300-01 - 46-6300-04

46-6300-03
Fig. 3

46-6300-04
Fig. 4

cm St. CLAIR-THOMSON
21,0 46-6306-01 - 46-6306-04

46-6306-03
Fig. 3
16 mm

46-6306-04
Fig. 4
17 mm

RHINOLOGY

RHINOLOGIE

RINOLOGÍA

RINOLOGIA

Pharynx-Tonsillotome
Adenotomes
Adénotomes
Adenótomos
Adenotomi



cm LA FORCE
25,0 46-6401-01 - 46-6401-03

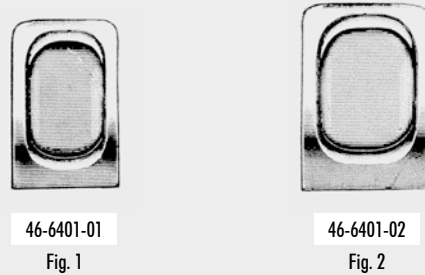

46-6401-01
Fig. 1

46-6401-02
Fig. 2



46-6401-03
Fig. 3

Fig.
1 46-6402-01
2 46-6402-02
3 46-6402-03

Mit einer Ersatzklinge
With one spare blade
Avec une lame de rechange
Con una hoja de repuesto
con una lama di ricambio

Ersatzklingen, allein
Spare Blades only
Lames de rechange seules
Hojas de repuesto sueltas
Lame di ricambio sole



46-6300-01

46.42

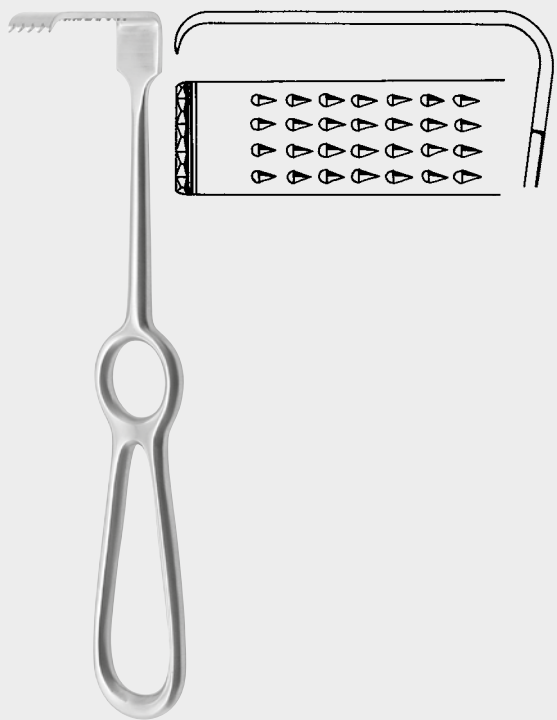

cm BRÜNINGS-BRUNK
19,0 46-6420-19

cm MILES
9,0 46-6502-09
11,5 46-6502-11

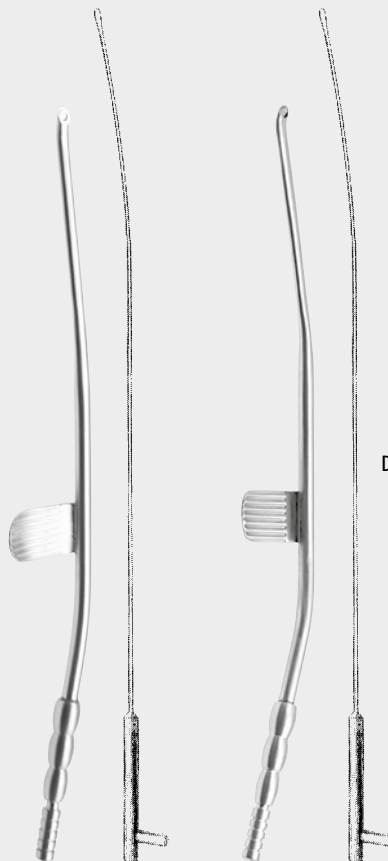

cm GUILLEN
20,0 46-6511-20

mm 20,0 cm
4,0 46-6513-04
5,0 46-6513-05

Kieferhöhlen-Haken, Spülkanülen
Antrum Retractor, Irrigating Cannulas
Écarteur pour le sinus maxillaire, Canules à irrigation
Separador de seno maxilar, Cánulas de irrigación
Divaricatore di seno mascellare, Cannule per irrigazione

RHINOLOGIE

RHINOLOGY

RHINOLOGIE

RINOLOGÍA

RINOLOGIA



cm FREER
21,0 46-6515-21



cm GORNEY
18,0 46-6520-18



cm NEGUS
21,0 46-6521-21



ø mm PAULSEN 17,5 cm
1,5 46-6523-15
2,5 46-6523-25



mm RITTER-HALLE
2,5 46-6531-25
3,0 46-6531-30
4,0 46-6531-40
5,0 46-6531-50

Saug-Elevatorium, Stirnhöhlen-Dilatatoren
Aspirating Elevator, Frontal Sinus Dilators
Élévateur aspirant, Dilatateurs pour le sinus frontal
Elevador aspirador, Dilatadores para el seno frontal
Elevatore con aspirazione, Dilatatori per il seno frontale



46-6420-19 - 46-6531-50

46.43