

UROLOGIE

UROLOGY

UROLOGIE

UROLOGÍA

UROLOGIA

Distributed in New Zealand by:



Cooper Medical Limited
57 Mahunga Drive
Mangere Bridge
Auckland 2022



Prostata-Instrumente
 Prostata Instruments
 Instruments prostatiques
 Instrumentos prostáticos
 Strumenti prostatici

Prostata-Haken - Prostatic Retractors - Écarteurs prostatiques - Separadores prostáticos
 Divaricatori prostatici

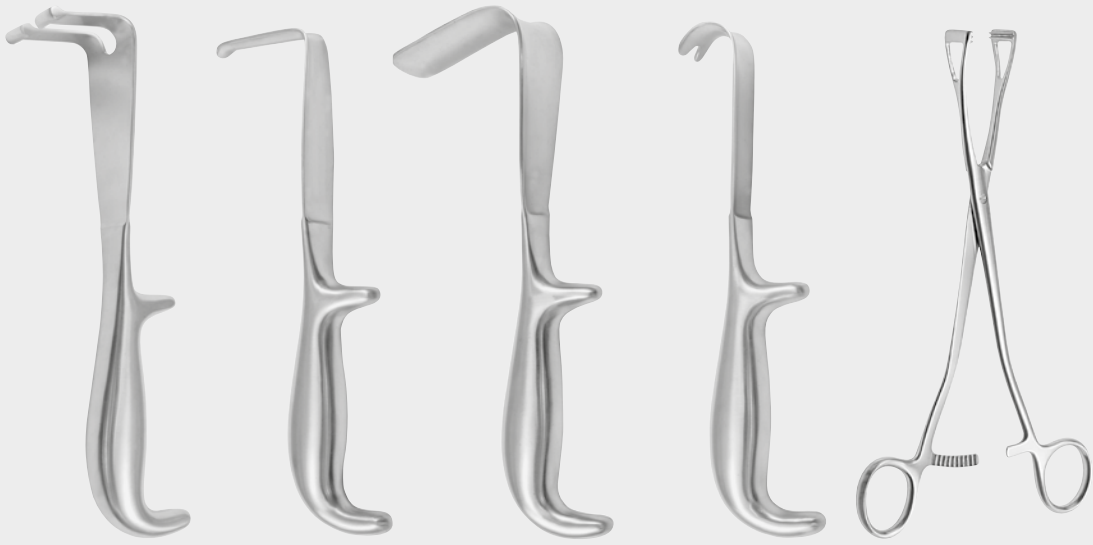

cm YOUNG
 22,0 66-1000-22

cm YOUNG
 21,0 66-1001-21

cm YOUNG
 22,0 66-1003-22

cm YOUNG
 21,0 66-1005-21

cm YOUNG
 20,0 66-1006-20

UROLOGIE

UROLOGY

UROLOGIE

UROLOGÍA

UROLOGIA

Prostata-Fasszange - Prostatic Seizing Forceps - Pince à saisir la prostate - Pinza para sacar la próstata - Pinza per afferrare la prostata

Kapsel-Fasszangen - Capsule Seizing Forceps - Pincas capsulaires - Pinzas capsulares - Pinze capsulari

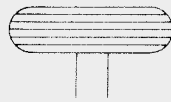

cm
 23,0 66-1101-23

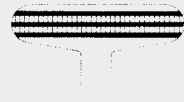

cm
 23,0 66-1107-23

- atraumatisch
- atraumatic
- atraumatiques
- atraumáticas
- atraumatiche



MILLIN

66-1101-23 - 66-1205-24

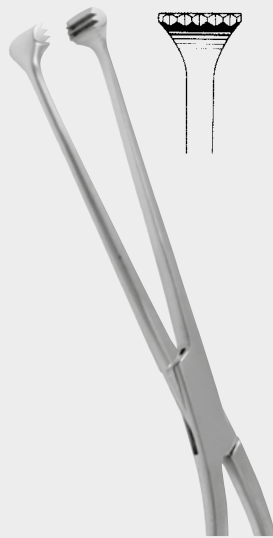

cm MILLIN
 23,0 66-1203-23

Fasszange für vordere Lappen
 Lobe Holding Forceps
 Pince pour saisir les lambeaux
 Pinza para lóbulos anteriores
 Pinza per lobuli anteriori

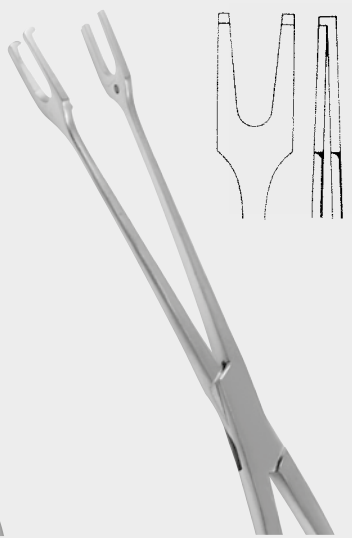

cm MILLIN
 24,0 66-1205-24

Faden-Führungszange
 Ligature Holding Forceps
 Pince à ligatures
 Pinza para ligaduras
 Pinza per legature



LEGUEU
66-1407-27

KOCHER
66-1409-27

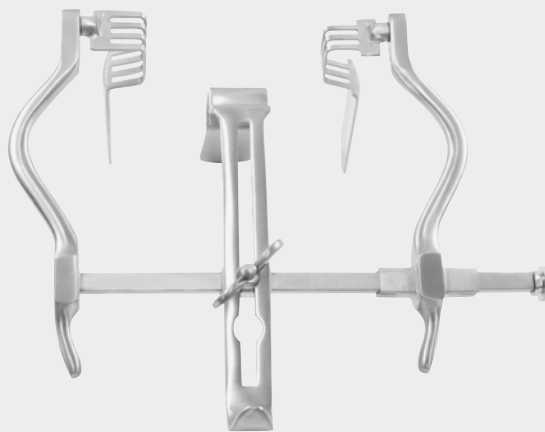

JUDD-MASSON
66-1500-00

Blasen-Wundhaken, -Wundsperrer
Bladder Retractors
Écarteurs vésicaux
Separadores vesicales
Divaricatori vescicali

UROLOGIE

UROLOGY

UROLOGIE

UROLOGÍA

UROLOGIA

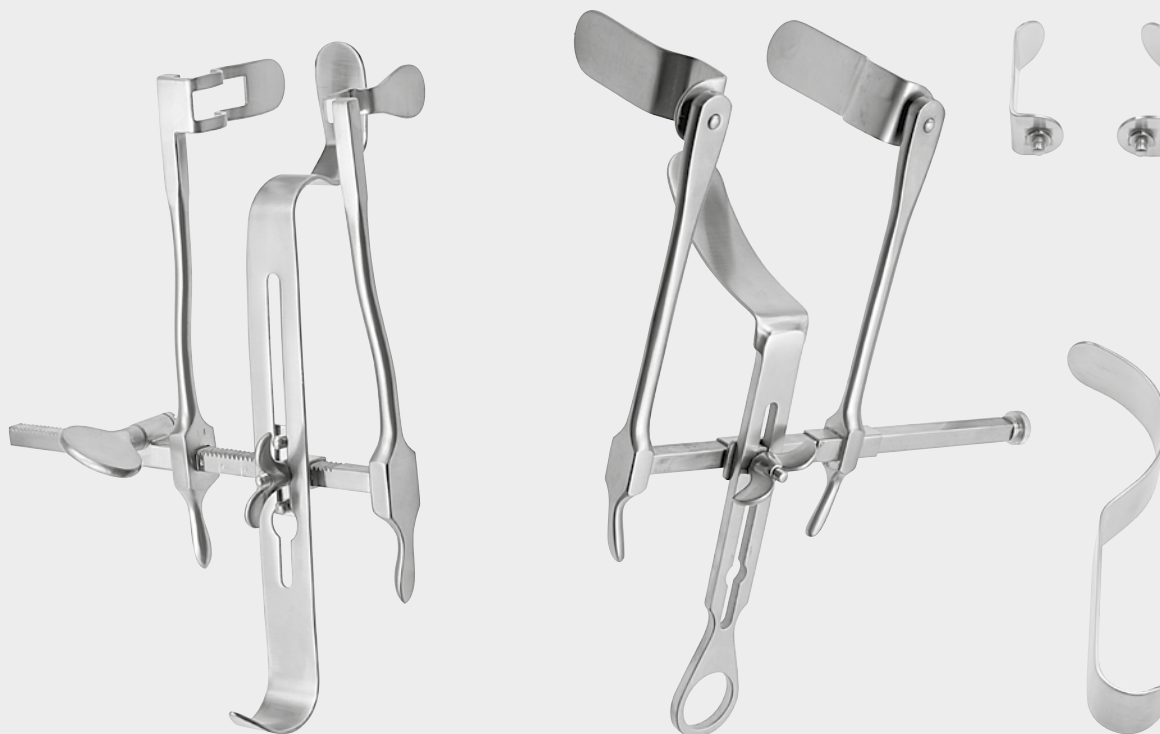

HRYNTSCHAK
66-1502-08 Kinder / Child / Enfant / Niño / Bambini
66-1502-11 Erwachsene / Adult / Adulte / Adulto

THOMSON-WALKER
66-1600-00

ZEPF®
INSTRUMENTS

66-1600-00

66.3

Blasen- und Wundspreizer
Bladder and Wound Retractor
Écarteur vésical
Separador vesical
Divaricatore vescicale

UROLOGIE

UROLOGY

UROLOGIE

UROLOGÍA

UROLOGIA

Urethrotome
Urethrotomes
Urétérotomes
Ureterótomos
Uretrotomi

Blasenhals-Sperrer
Bladder Neck Spreader
Écarteur pour le col de la vessie
Separador para el cuello de la vejiga
Divaricatore per il collo della vescica



MILLIN
66-1602-00

LEGUEU
66-1603-00

MILLIN
66-1605-00

cm PITHA
22,0 66-1607-22

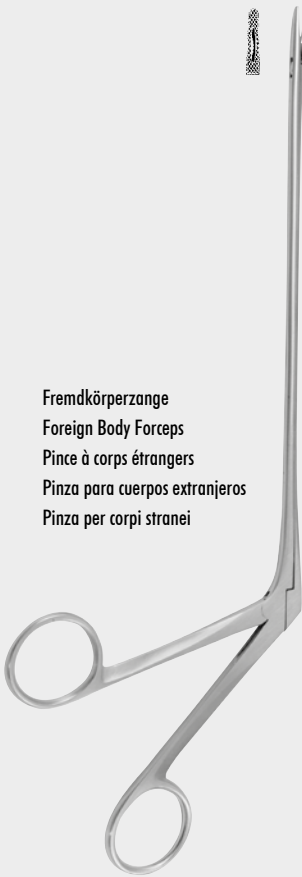

Fremdkörperzange
Foreign Body Forceps
Pince à corps étrangers
Pinza para cuerpos extranjerios
Pinza per corpi strani

cm MATHIEU
20,0 66-1608-20
28,0 66-1608-28

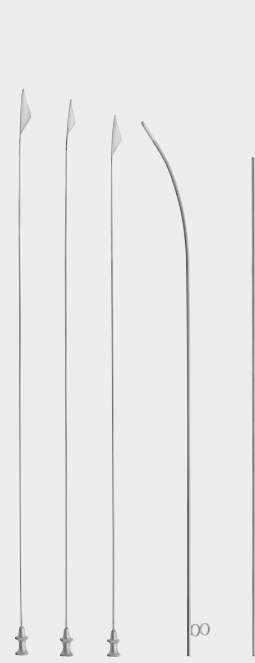

MAISONNEUVE
66-1700-00
compl.

66-1700-01

Holzetui
Box of wood only
Boîte bois seule
Estuche de madera suelto
Astuccio in legno solo



OTIS
66-1702-00

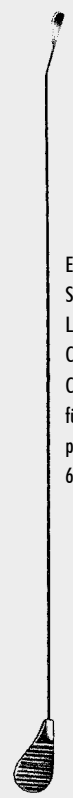
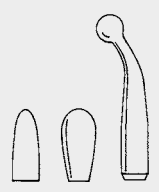

66-1702-99

Ersatzmesser
Spare Blade
Lame de rechange
Cuchillo de repuesto
Coltello di ricambio
für / for / pour /
para / per
66-1702-00

Circumcisions-Instrumente - Circumcision Instruments -
 Instruments à circoncision - Instrumentos para circunción
 Strumenti per circoncisione

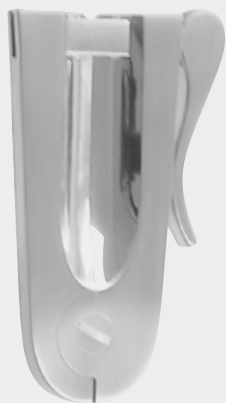

mm **MOGEN 7,5 mm**
 2,5 66-1703-00

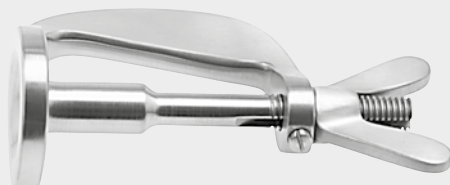

ø mm **WINKELMANN**
 12 66-1703-12
 16 66-1703-16
 20 66-1703-20

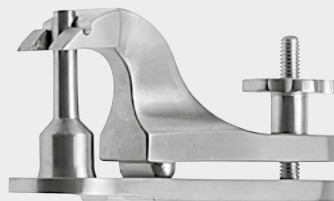

ø mm
 8 66-1704-08
 11 66-1704-11
 13 66-1704-13
 16 66-1704-16
 21 66-1704-21
 26 66-1704-26
 32 66-1704-32

Penis, Urethra
 Penis, Urethra
 Pénis, Urètre
 Penis, Uretra
 Pene, Uretra

UROLOGIE

UROLOGY

UROLOGIE

UROLOGÍA

UROLOGIA

Sekretlöffel
 Secretion Scoops
 Cuiller à sécrétions
 Cucharilla para secreciones
 Cucchiari per secrezione



cm **STOCKMANN**
 8,0 66-1705-08

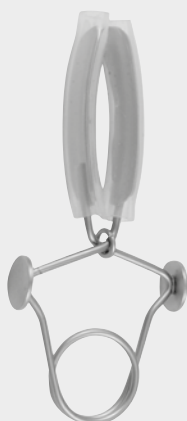

cm **STRAUSS**
 11,0 66-1707-11

Penisklemmen - Meatus Clamps - Compresseurs de l'urètre
 Compresores uretrales - Serrapene



GUTMANN
 66-1800-26

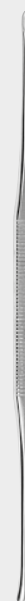

ASCH
 66-1802-20



cm
 12,5 66-1710-12



cm **COLLINGWOOD**
 14,0 66-1714-14

Penis, Urethra
 Penis, Urethra
 Pénis, Urètre
 Penis, Uretra
 Pene, Uretra

UROLOGIE

UROLOGY

UROLOGIE

UROLOGÍA

UROLOGIA

Harnröhren-Dilatationsbesteck, komplett
 Urethral Dilation Set, complete
 Jeu complet d'instruments pour la dilatation de l'urètre
 Juego de instrumentos completo para la dilatación de la uretra
 Set di strumenti completo per la dilatazione uretrale



66-1804-35

66.6



cm GUYON
 39,0 66-1804-39



cm GUYON
 35,0 66-1805-35

Katheterspanner
 Catheter Introducers
 Introducteurs de cathéters
 Introducutores de catéteres
 Introduuttori per cateteri



cm
 46,0 66-1807-46



cm DITTEL
 46,0 66-1809-46



cm GUYON
 46,0 66-1811-46

mit 4 Gleitsonden 3, 4, 5 und 6 Charr.
 with 4 filiform guides 3, 4, 5, and 6 Fr.
 avec 4 bougies conductrices 3, 4, 5 et 6 Charr.
 con 4 bujías conductoras 3, 4, 5 y 6 Charr.
 con 4 stiletto di guida 3, 4, 5 e 6 Charr.

	Ch./FG.	No.
* Zwischengrößen:	9	66-2005-09
Intermediate Sizes:	11	66-2005-11
Dimensions intermédiaires:	.	.
Dimensiones intermedias:	.	.
Dimensioni intermedi:	39	66-2005-39



GUYON
 66-2000-00
 compl.

Dilatations-Bougies, Metallkatheter
 Dilating Bougies, Metal Catheters
 Bougies dilatatrices, Cathéters métalliques
 Bujías dilatadoras, Catéteres metálicos
 Candelette dilatatrici, Cateteri metallici



UROLOGIE

UROLOGY

UROLOGIE

UROLOGÍA

UROLOGIA

Charr. / FG.	van BUREN	DITTEL	DITTEL	GUYON	GUYON	LISTER
0						66-2009-00
1						66-2009-01
2						66-2009-02
5						66-2009-05
6	66-2001-06			66-2005-06		66-2009-06
7				66-2005-07		66-2009-07
8	66-2001-08	66-2003-08	66-2004-08	66-2005-08		66-2009-08 66-2101-08
9		66-2003-09	66-2004-09	66-2005-09		66-2009-09
10	66-2001-10	66-2003-10	66-2004-10	66-2005-10	66-2007-10	66-2009-10 66-2101-10
11		66-2003-11	66-2004-11	66-2005-11	66-2007-11	66-2009-11
12	66-2001-12	66-2003-12	66-2004-12	66-2005-12	66-2007-12	66-2009-12 66-2101-12
13		66-2003-13	66-2004-13	66-2005-13	66-2007-13	66-2009-13
14	66-2001-14	66-2003-14	66-2004-14	66-2005-14	66-2007-14	66-2009-14 66-2101-14
15		66-2003-15	66-2004-15	66-2005-15	66-2007-15	66-2009-15
16	66-2001-16	66-2003-16	66-2004-16	66-2005-16	66-2007-16	66-2009-16 66-2101-16
17		66-2003-17	66-2004-17	66-2005-17	66-2007-17	66-2009-17
18	66-2001-18	66-2003-18	66-2004-18	66-2005-18	66-2007-18	66-2009-18 66-2101-18
19		66-2003-19	66-2004-19	66-2005-19	66-2007-19	
20	66-2001-20	66-2003-20	66-2004-20	66-2005-20	66-2007-20	66-2101-20
21		66-2003-21	66-2004-21	66-2005-21	66-2007-21	
22	66-2001-22	66-2003-22	66-2004-22	66-2005-22	66-2007-22	66-2101-22
23		66-2003-23	66-2004-23	66-2005-23	66-2007-23	
24	66-2001-24	66-2003-24	66-2004-24	66-2005-24	66-2007-24	66-2101-24
25		66-2003-25	66-2004-25	66-2005-25	66-2007-25	
26	66-2001-26	66-2003-26	66-2004-26	66-2005-26	66-2007-26	
27		66-2003-27	66-2004-27	66-2005-27	66-2007-27	
28	66-2001-28	66-2003-28	66-2004-28	66-2005-28	66-2007-28	
29		66-2003-29	66-2004-29	66-2005-29	66-2007-29	
30	66-2001-30	66-2003-30	66-2004-30	66-2005-30	66-2007-30	
32	66-2001-32			66-2005-32	mit Innengewinde	
34	66-2001-34			66-2005-34	with inner thread	
36	66-2001-36			66-2005-36	avec filet intérieur	
38	66-2001-38			66-2005-38	con rosca interior	
40	66-2001-40			66-2005-40	con filetto interiore	



66-2004-00

66.7

Metallkatheter, Dilatations-Bougies
 Metal Catheters, Dilating Bougies
 Cathéters métalliques, Bougies dilatatrices
 Catéteres metálicos, Bujías dilatadoras
 Cateteri metallici, Candelette dilatatrici

UROLOGIE

UROLOGY

UROLOGIE

UROLOGÍA

UROLOGIA

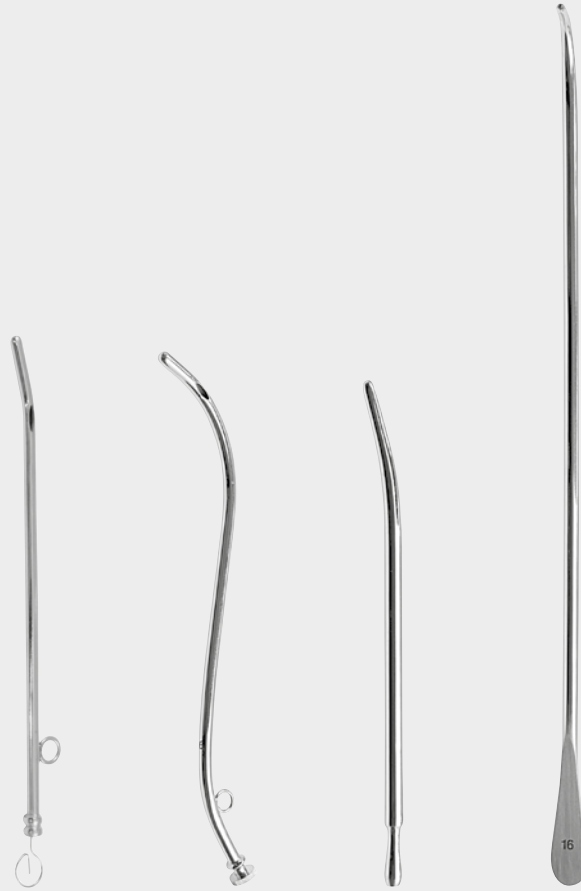

Charr. / FG.		COXETER	WALTHER	CAMPBELL
6				66-2129-06
8	66-2103-08	66-2109-08		66-2129-08
10	66-2103-10	66-2109-10		66-2129-10
12	66-2103-12	66-2109-12	66-2111-12	66-2129-12
14	66-2103-14	66-2109-14	66-2111-14	66-2129-14
16	66-2103-16	66-2109-16	66-2111-16	66-2129-16
18	66-2103-18	66-2109-18	66-2111-18	66-2129-18
20	66-2103-20	66-2109-20	66-2111-20	66-2129-20
22	66-2103-22	66-2109-22	66-2111-22	66-2129-22
24	66-2103-24	66-2109-24	66-2111-24	
26			66-2111-26	
28			66-2111-28	
30			66-2111-30	
32			66-2111-32	
34			66-2111-34	
36			66-2111-36	
38			66-2111-38	
40				
			13,5 cm	28,0 cm

ZEPF[®]
α
 INSTRUMENTS

66-2103-08

66.8

Dilatations-Bougies
 Dilating Bougies
 Bougies dilatatrices
 Bujías dilatadoras
 Candelette dilatatrici

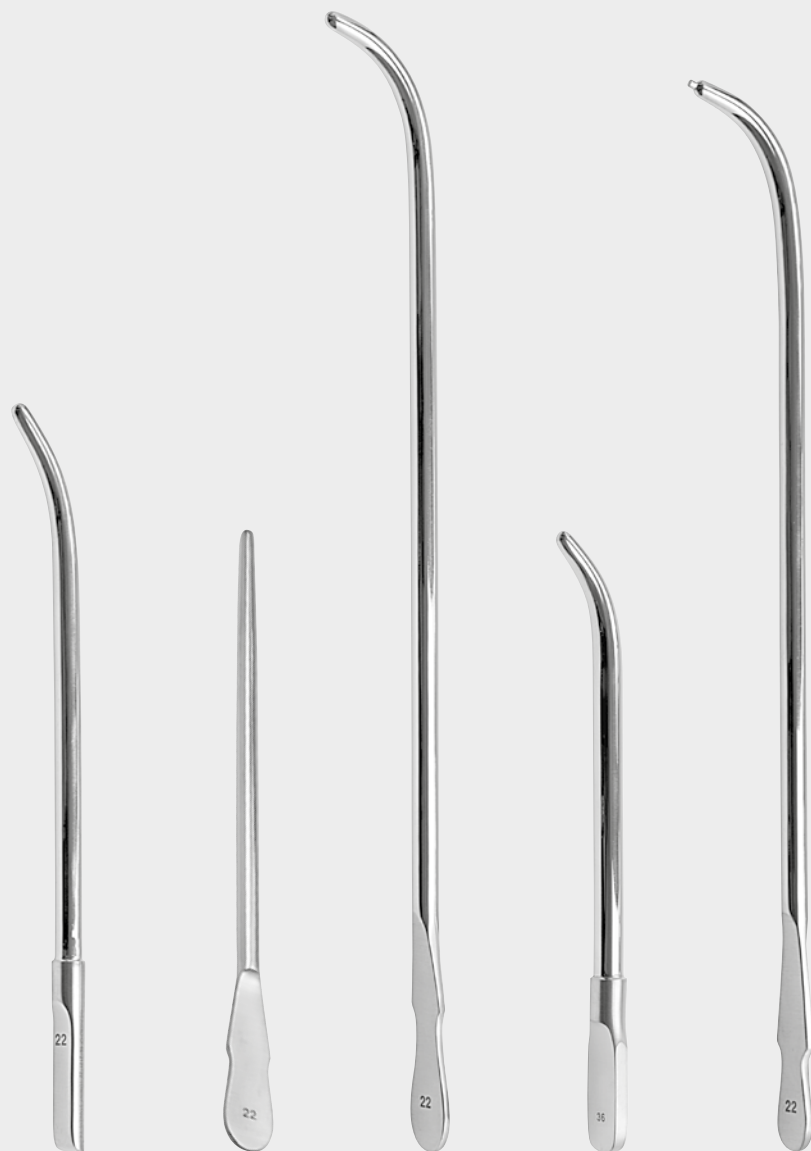

UROLOGIE

UROLOGY

UROLOGIE

UROLOGÍA

UROLOGIA

Charr. / FG.	McCREA	JEWETT	OTIS	WALTHER	LEFORT
6	66-2131-06	66-2132-06	66-2133-06		66-2137-06
8	66-2131-08	66-2132-08	66-2133-08		66-2137-08
10	66-2131-10	66-2132-10	66-2133-10		66-2137-10
12	66-2131-12	66-2132-12	66-2133-12		66-2137-12
14	66-2131-14	66-2132-14	66-2133-14		66-2137-14
16	66-2131-16	66-2132-16	66-2133-16	66-2135-16	66-2137-16
18	66-2131-18	66-2132-18	66-2133-18	66-2135-18	66-2137-18
20	66-2131-20	66-2132-20	66-2133-20	66-2135-20	66-2137-20
22	66-2131-22	66-2132-22	66-2133-22	66-2135-22	66-2137-22
24	66-2131-24	66-2132-24	66-2133-24	66-2135-24	66-2137-24
26	66-2131-26	66-2132-26	66-2133-26	66-2135-26	66-2137-26
28	66-2131-28	66-2132-28	66-2133-28	66-2135-28	66-2137-28
30	66-2131-30	66-2132-30	66-2133-30	66-2135-30	66-2137-30
32	66-2131-32	66-2132-32	66-2133-32	66-2135-32	66-2137-32
34	66-2131-34	66-2132-34	66-2133-34	66-2135-34	66-2137-34
36	66-2131-36		66-2133-36	66-2135-36	66-2137-36
38			66-2133-38		
40			66-2133-40		
	19,5 cm	24,0 cm	30,0 cm	24,0 cm	28,0 cm



66-2131-06 - 66-2137-36

66.9



UROLOGIE

UROLOGY

UROLOGIE

UROLOGÍA

UROLOGIA



MASTDARM

RECTUM

RECTUM

RECTO

RETTO



Mastdarm-Spekula
 Rectal Specula
 Spéculums rectaux
 Espéculos rectales
 Specoli rettali

MASTDARM

RECTUM

RECTUM

RECTO

RETTO



cm CZERNY
 22,0 68-1005-22

mm SAWYER
 65 x 22 68-1008-22
 76 x 29 68-1008-29
 89 x 38 68-1008-38

mm HILL FERGUSSON 21,5 cm
 64 x 24 68-1010-24
 72 x 32 68-1010-32
 76 x 35 68-1010-35

cm SIMS
 15,0 68-1100-15



cm BODENHAMMER
 15,0 68-1105-15
 68-1107-15 Kaltlicht
 Cold Light
 Lumière froide
 Luz fría
 Luce fredda



PRATT
 68-1201-00

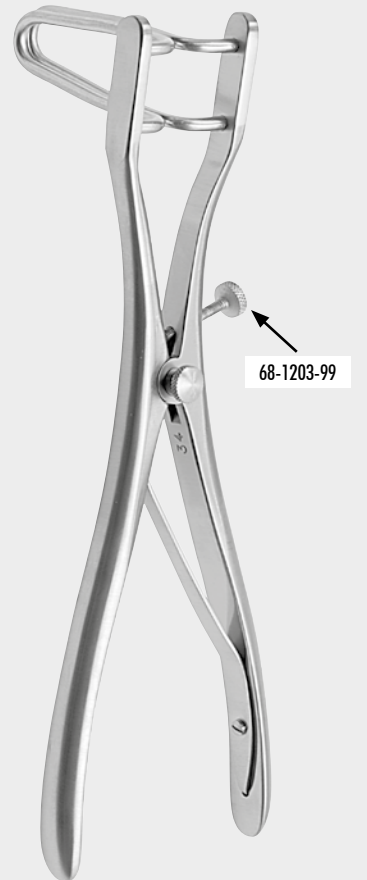

mm SCHULZE-BERGMANN (SIMS)
 60 x 20 68-1203-06
 80 x 20 68-1203-08
 120 x 20 68-1203-12



cm BARR
17,0 68-1205-17
70 x 22 mm



cm MATHIEU
19,5 68-1300-19

68-1300-99

Mastdarm-Spekula
Rectal Specula
Spéculums rectaux
Espéculos rectales
Specoli rettali

MASTDARM

RECTUM

RECTUM

RECTO

RETTO

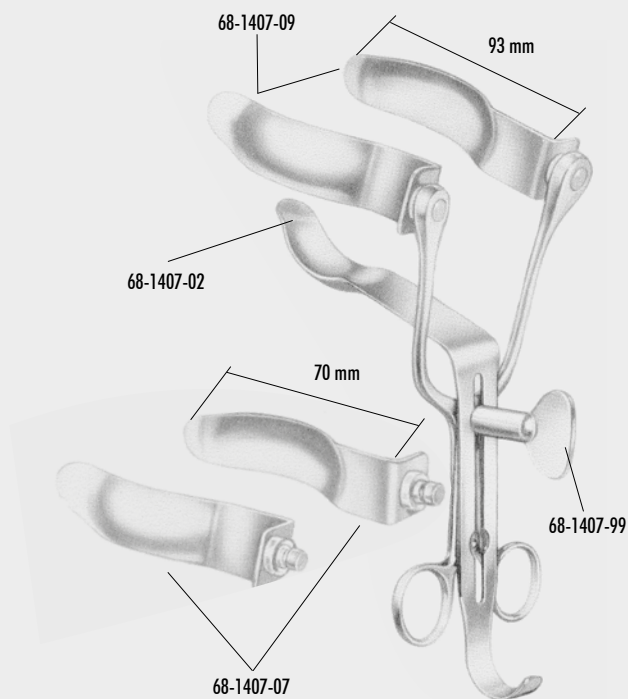

cm ALAN-PARKS compl.
13,5 68-1407-00
13,5 68-1408-00 Kaltlicht
Cold Light
Lumière froide
Luz fría
Luce fredda



cm SMITH-BUIE
15,0 68-1500-15
75 x 23 mm

Mastdarm-Spreizer
Anal Retractors
Dilatateurs pour anus et rectum
Separadores rectales
Dilatatori per l'ano e il retto



68-1500-15

68.3



Rektoskope, Proktoskope
 Rectoscopes, Proctoscopes
 Rectoscopes, Proctoscopes
 Rectoscopios, Proctoscopios
 Rettoscopi, Proctoscopi

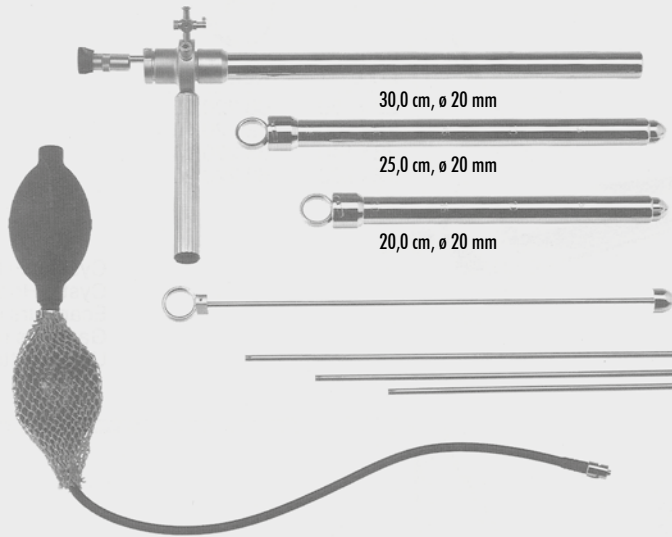

30,0 cm, ø 20 mm

25,0 cm, ø 20 mm

20,0 cm, ø 20 mm

STRAUSS Kaltlicht-Beleuchtung · Fibre Light Illumination
 68-1601-00 Illumination par lumière froide · Iluminación por luz fría
 compl. Illuminazione con luce fredda

MASTDARM

RECTUM



RECTUM



RECTO

RETTO

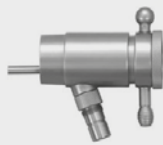

Kaltlicht-Aufsatz mit Fenster, komplett
 Cold Light Chamber with Window, complete
 Adaptateur lumière froide complet avec fenêtre
 Cabeza de luz fría completa con ventanilla
 Adattatore luce fredda completo con finestra



Fenster, allein
 Window only
 Fenêtre seule
 Ventanilla suelta
 Finestra sola



Kaltlicht-Aufsatz einzeln
 Cold Light Chamber only
 Adaptateur lumière froide seul
 Cabeza de luz fría suelta
 Adattatore luce fredda solo



Kaltlichtleiter allein
 Cold Light guide only
 Conducteur lumière froide seul
 Guía de luz fría suelta
 Guida di luce fredda sola

68-1702-99

Ersatzglas für:
 spare glass for:
 verre de rechange pour:
 vidrio de repuesto para:
 vetro di ricambio per:

68-1702-01

LLOYD-DAVIS Kaltlicht-Beleuchtung · Fibre Light Illumination
 68-1700-00 Illumination par lumière froide · Iluminación por luz fría
 compl. Illuminazione con luce fredda



68-1601-00

68.4

Anoskope
Anoscopes
Anuscospes
Anoscopios
Anoscopi



ø mm IVES-FANSLER
22 68-2100-22
L = 80 mm



ø mm FANSLER
25 68-2101-25
29 68-2101-29
38 68-2101-38
L = 65 mm



ø mm HIRSCHMANN
16 68-2102-16
19 68-2102-19
22 68-2102-22

MASTDARM

RECTUM

RECTUM

RECTO

RETTO



ø mm KELLY
21 68-2204-21
27 68-2204-27
L = 50 mm



ø mm NEWMAN
16 68-2210-16
19 68-2210-19
23 68-2210-23
L = 63 mm

Anoskope
Anoscopes
Anuscopes
Anoscopios
Anoscopi

MASTDARM

RECTUM

RECTUM

RECTO

RETTO



ø mm x L	KELLY
22 x 50	68-2200-05
22 x 100	68-2200-10
22 x 140	68-2200-14
22 x 200	68-2200-20



mm	CHELSEA-EATON
22	68-2212-22
30	68-2212-30
L = 65 mm	



ø mm	BENSAUDE
19	68-2222-19
22	68-2222-22
L = 70 mm	



ø mm	GABRIEL
19 x 49	68-2230-49
25 x 64	68-2230-64

ZEPF®
α
INSTRUMENTS

68-2200-05

68.6



68-2501-01
Fig. 1



68-2501-02
Fig. 2



68-2501-03
Fig. 3

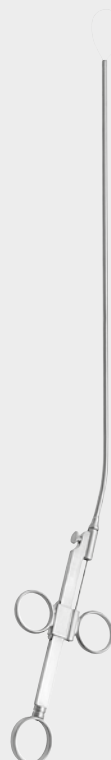
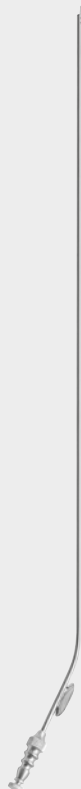

PRATT
68-2501-01 - 68-2501-03

Cystikus-Haken - Krypt Hooks
Écarteurs rectaux - Ganchos rectales
Uncini rettali

cm
24,0 68-2503-24

cm **BUIE**
41,0 68-2601-41

Saug-Kanüle
Aspirating Tube
Tube d'aspiration
Tubo de aspiración
Tubo di aspirazione

cm **WESTON**
30,0 68-2603-30

Rektl-Polypenschnürer
Rectal Polypus Snare
Serre-nœud rectal
Cierranudos rectal
Serranodi rettale

MASTDARM

RECTUM

RECTUM

RECTO

RETTO

Biopsie-Zangen
Biopsy Specimen Forceps
Pincas emporte-pièce à biopsie
Pinzas sacabocado para biopsia
Pinze per biopsia

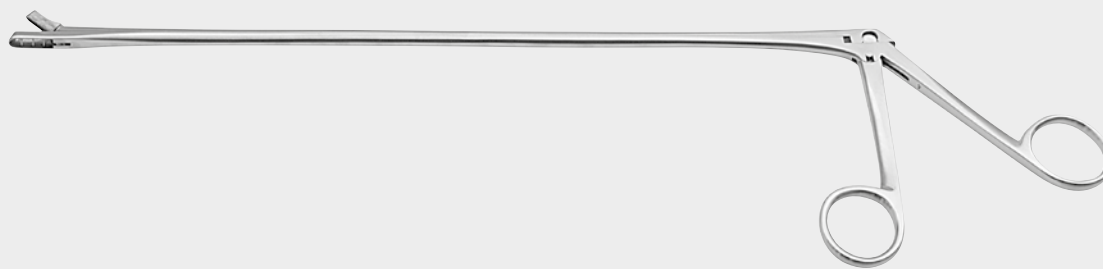

Fig. 1

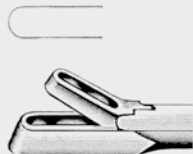

Fig. 2

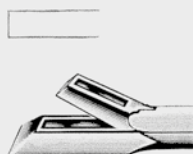

Fig. 3



Fig. 4

cm	YEOMAN			
28,0	68-3001-28	68-3002-28	68-3003-28	68-3004-28
35,0	68-3001-35	68-3002-35	68-3003-35	68-3004-35
42,0	68-3001-42	68-3002-42	68-3003-42	68-3004-42



68-3004-42

68.7

Biopsie-Zangen
 Biopsy Specimen Forceps
 Pinces emporte-pièce à biopsie
 Pinzas sacabocado para biopsia
 Pinze per biopsia

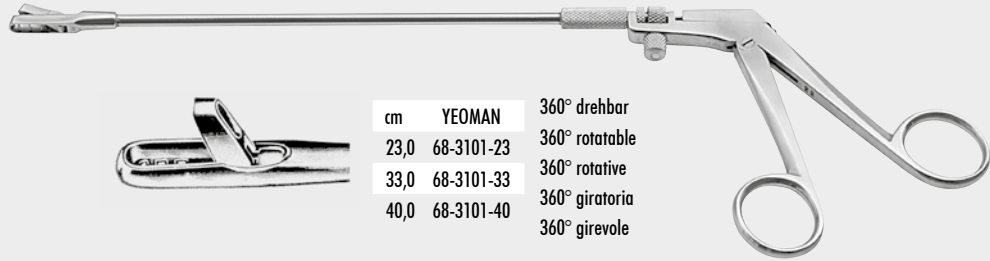

MASTDARM

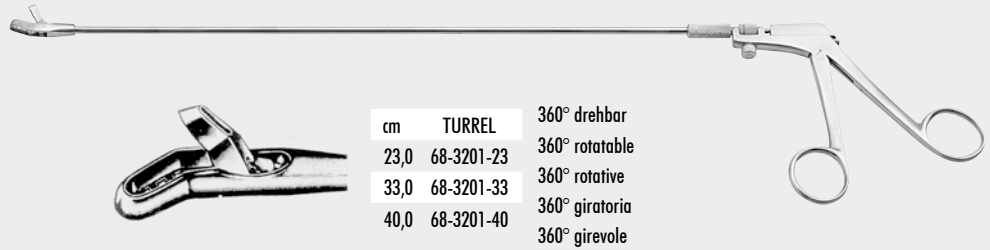

RECTUM

RECTUM

RECTO

RETTO

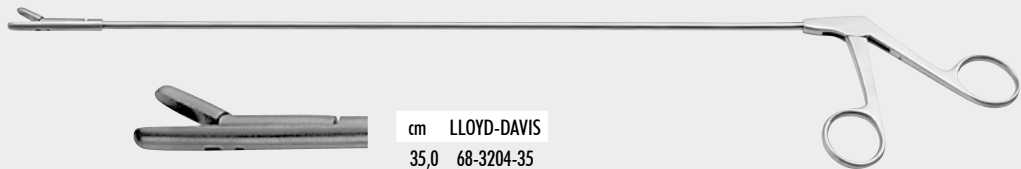

Fasszange bei Biopsie
 Grasping Forceps used for biopsy
 Pince à saisir le tissu pour la biopsie
 Pinza de agarre para biopsia
 Pinza afferrante per biopsia

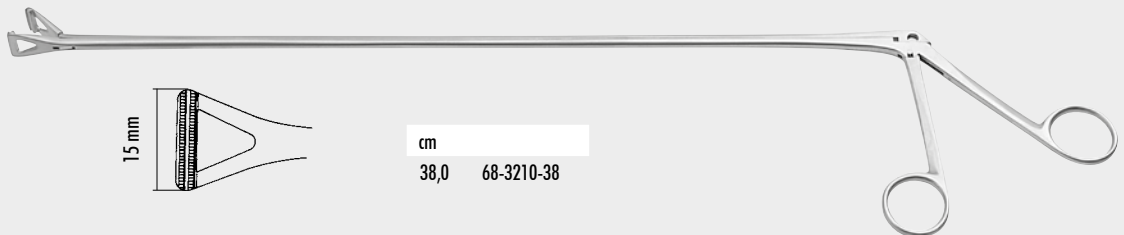

ZEPF®
α
 INSTRUMENTS

68-3101-23

68.8

Haemorrhoiden-Zangen
 Pile Forceps
 Pincès à hémorroïdes
 Pinzas para hemorroides
 Pinze per emorroidi



cm HEYWOOD-SMITH
 21,0 68-4000-21

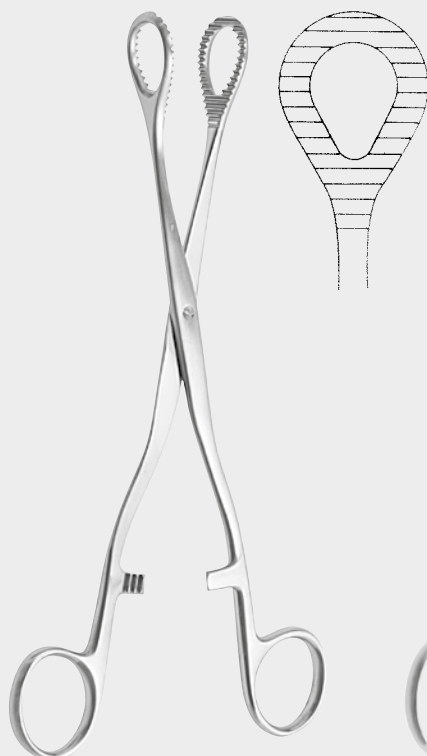

cm HEYWOOD-SMITH
 21,0 68-4002-21



cm HEYWOOD-SMITH modif.
 21,0 68-4002-22

MASTDARM

RECTUM

RECTUM

RECTO

RETTO



cm HEYWOOD-SMITH
 25,0 68-4002-25



cm LUER
 24,5 68-4006-24

ZEPF[®]

 INSTRUMENTS

68-4006-24

68.9

Haemorrhoiden-Zangen
 Pile Forceps
 Pinces à hémorroïdes
 Pinzas para hemorroides
 Pinze per emorroidi

MASTDARM

RECTUM

RECTUM

RECTO

RETTO



cm St. GEORGE
 20,0 68-4007-20



cm MC GIVNEY
 19,0 68-4008-19

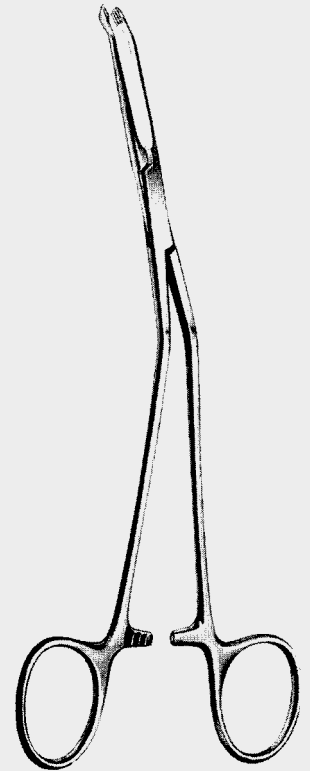

cm McGIVNEY
 19,0 68-4009-19



cm BARRON
 25,0 68-4010-25

ZEPF®
α
 INSTRUMENTS

68-4007-20

68.10



MC GIVNEY
68-4300-00

Haemorrhoidal Ligatoren
Haemorrhoidal Ligators
Ligateurs hémorroïdaux
Ligadores hemorroidales
Ligatori emorroidali



ø mm RUDD
12,0 68-4302-00



68-4305-99

MASTDARM

RECTUM

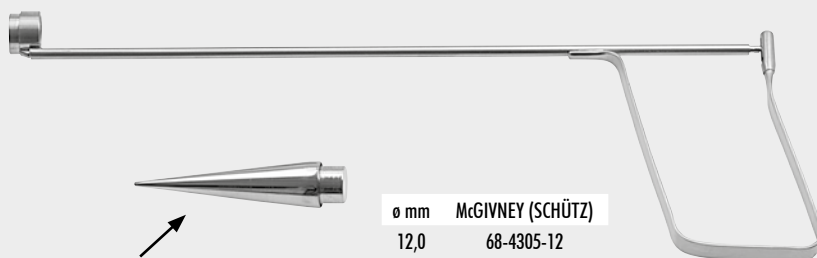

ø mm McGIVNEY (SCHÜTZ)
12,0 68-4305-12

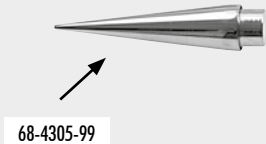

68-4305-99

RECTUM

RECTO

RETTO

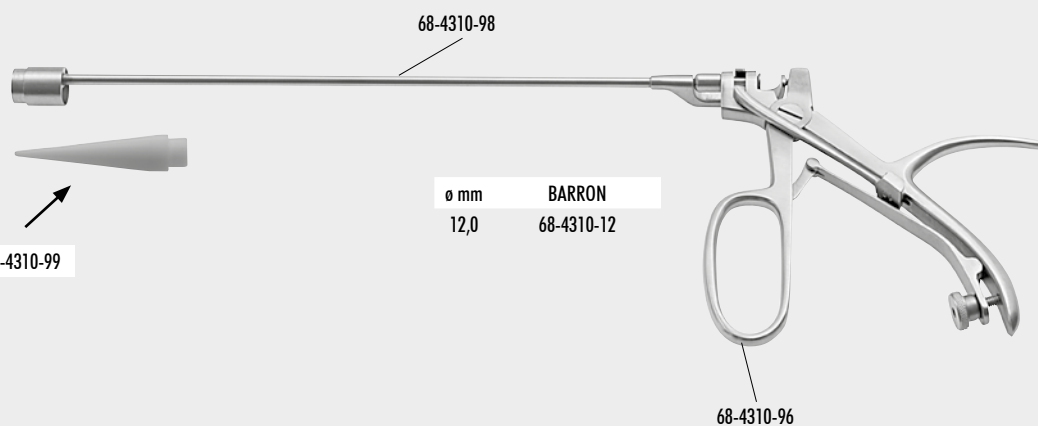

ø mm BARRON
12,0 68-4310-00

68-4310-99

68-4310-96



68-4310-99

68.11



Haemorrhoidal Saugligatoren
 Haemorrhoidal Aspirating Ligators
 Ligateurs aspireurs hémorroïdaux
 Ligadores aspiradores hemorroidales
 Ligatori aspiratori emorroidali

90° abgewinkelt
 90° angled
 90° coudé
 90° acodado
 90° angolato

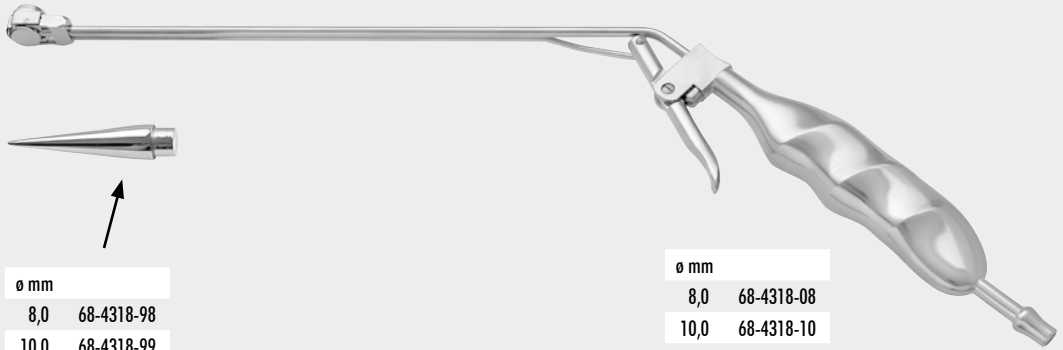

ø mm	
8,0	68-4318-98
10,0	68-4318-99

ø mm	
8,0	68-4318-08
10,0	68-4318-10

MASTDARM

30° aufwärts gewinkelt
 30° angled up
 30° coudé vers le haut
 30° acodado hacia arriba
 30° angolato in alto

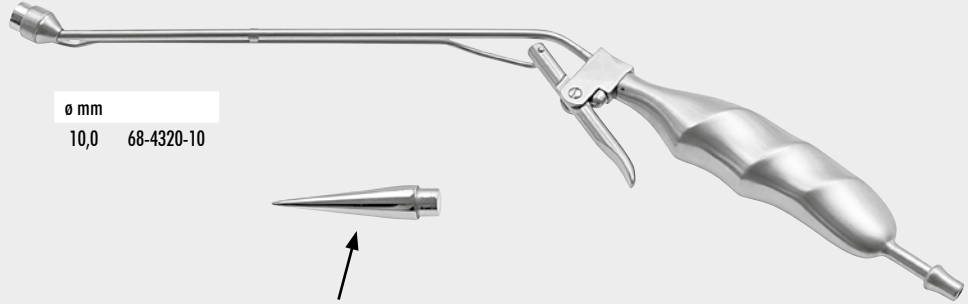

ø mm	
10,0	68-4320-10



RECTUM

RECTUM

RECTO

RETTO

30° abwärts gewinkelt
 30° angled down
 30° coudé vers le bas
 30° acodado hacia abajo
 30° angolato in basso



ø mm	
10,0	68-4322-10



68-4332-00

Ligatur Gummi Ringe 100 Stück, Latex-frei
 Ligature Rubber Rings 100 ea., Latex free
 Anneaux à ligature en les 100,
 Anillos de ligadura de 100 c/u,
 Anelli di legatura in 100 pezzi,



68-4318-98 - 68-4332-00

68.12