

PINZETTEN

FORCEPS

PINCES

PINZAS

PINZE

Distributed in New Zealand by:



Cooper Medical Limited
57 Mahunga Drive
Mangere Bridge
Auckland 2022





Mit TC-Einsätzen
 TC Lined
 A mors TC
 Con bocas TC
 Con morso TC

Anatomische Pinzetten
 Dissecting Forceps
 Pincés à dissection
 Pinzas anatómicas de disección
 Pinze anatomiche per dissezione

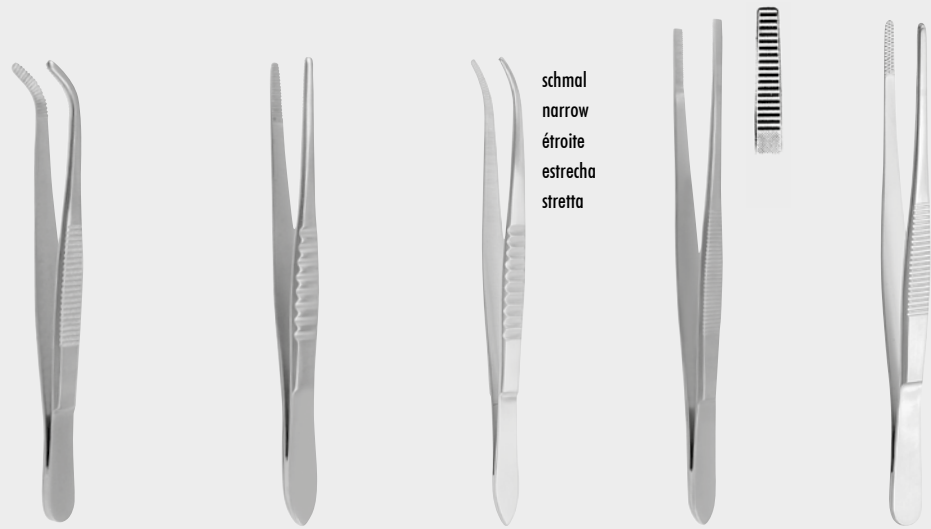

schmal
 narrow
 étroite
 estrecha
 stretta

kreuzgerieft
 cross serrated
 striée quadr.
 estr. cuadrada
 striata quad.

PINZETTEN

cm	—	—	—
10,5	10-1002-10		
11,5	10-1002-11		
13,0	10-1002-13	10-1003-13	
14,5	10-1002-14	10-1003-14	
16,0	10-1002-16	10-1003-16	
18,0	10-1002-18		
20,0	10-1002-20	10-1003-20	
23,0	10-1002-23		
25,0	10-1002-25	10-1003-25	
30,0	10-1002-30		
35,0	10-1002-35		
40,0	10-1002-40		

cm	USA
12,0	10-1004-12
13,0	10-1004-13
14,5	10-1004-14
15,5	10-1004-15
18,0	10-1004-18
21,0	10-1004-21
25,0	10-1004-25
30,0	10-1004-31

cm	USA
12,0	10-1005-12
13,0	10-1005-13
14,0	10-1005-14
15,0	10-1005-15

cm	STILLE
13,0	10-1006-13
15,0	10-1006-15
17,0	10-1006-17
20,0	10-1006-20

cm	
13,0	10-1008-13
14,0	10-1008-14
16,0	10-1008-16

FORCEPS

PINCES

PINZAS

PINZE

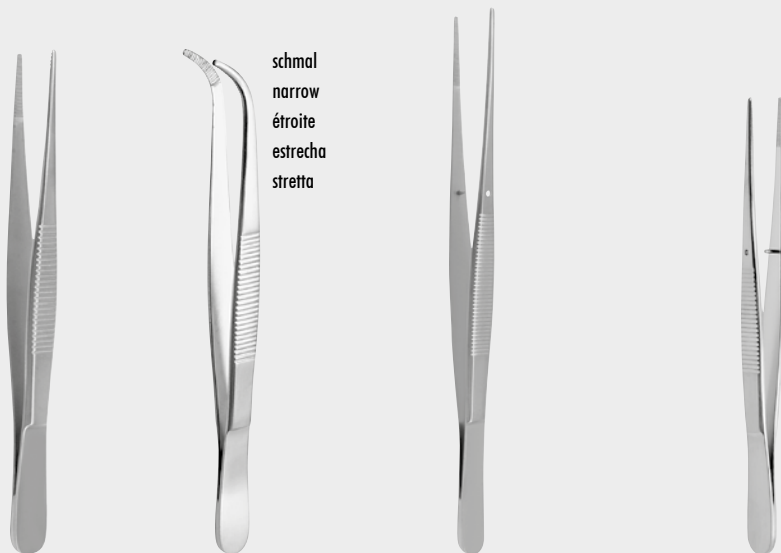

schmal
 narrow
 étroite
 estrecha
 stretta

fein
 fine
 fino

cm	—	—	—
10,5	10-1100-10		
11,5	10-1100-11		
13,0	10-1100-13		10-1101-13
14,5	10-1100-14	10-1104-14	10-1101-14
16,0	10-1100-16	10-1104-16	
18,0	10-1100-18		
20,0	10-1100-20	10-1104-20	
25,0	10-1100-25	10-1104-25	
30,0	10-1100-30		

cm	POTTS-SMITH
15,0	10-1106-15
18,0	10-1102-18
20,0	10-1106-20
21,0	10-1102-21
23,0	10-1102-23
25,0	10-1102-25
30,0	10-1102-30

cm	
13,0	10-1108-13
14,0	10-1108-14



10-1002-10

10.2

Mit TC-Einsätzen
TC Lined
A mors TC
Con bocas TC
Con morso TC



Chirurgische Pinzetten
Tissue Forceps
Pincès à dissection à griffes
Pinzas de disección con dientes
Pinze chirurgiche a denti

1:2



cm	—	⤿
10,5	10-1200-10	
11,5	10-1200-11	
13,0	10-1200-13	10-1201-13
14,5	10-1200-14	10-1201-14
16,0	10-1200-16	10-1201-16
18,0	10-1200-18	
20,0	10-1200-20	10-1201-20
23,0	10-1200-23	
25,0	10-1200-25	10-1201-25
30,0	10-1200-30	
35,0	10-1200-35	

1:2



cm	USA
12,0	10-1202-12
13,0	10-1202-13
14,5	10-1202-14
15,5	10-1202-15
18,0	10-1202-18
21,0	10-1202-21
25,0	10-1202-25
31,0	10-1202-31

1:2



cm	STILLE
15,0	10-1204-15

2:3



cm	STILLE
15,0	10-1205-15

PINZETTEN

FORCEPS

PINCES

PINZAS

PINZE

1:2



cm	POTTS-SMITH
18,0	10-1206-18
21,0	10-1206-21
25,0	10-1206-25

1:2



cm	ÖHLER
14,0	10-1214-14
16,0	10-1214-16
18,0	10-1214-18
20,0	10-1214-20
25,0	10-1214-25
30,0	10-1214-30

1:2



schmal
narrow
étroite
estrecha
stretta

cm	—	⤿
11,0	10-1300-11	
12,5	10-1304-12	
13,0	10-1300-13	10-1301-13
14,5	10-1300-14	10-1301-14
14,5	10-1304-14	
16,0	10-1300-16	
18,0	10-1300-18	10-1301-18
20,0	10-1300-20	
25,0	10-1300-25	



10-1301-14

10.3



Mit TC-Einsätzen
 TC Lined
 A mors TC
 Con bocas TC
 Con morso TC

Chirurgische Pinzetten
 Tissue Forceps
 Pincés à dissection à griffes
 Pinzas de disección con dientes
 Pinze chirurgiche a denti

PINZETTEN

FORCEPS

PINCES

PINZAS

PINZE

Feine anatomische Pinzetten
 Dissecting Forceps, delicate
 Pincés à dissection délicates
 Pinzas de disección delgadas
 Pinze per dissezione delicate

2:3



3:4



4:5



1:2



2:3



cm	
11,5	10-1400-11
13,0	10-1400-13
14,0	10-1400-14
16,0	10-1400-16
18,0	10-1400-18
20,0	10-1400-20
25,0	10-1400-25

cm	
13,0	10-1500-13
14,0	10-1500-14
16,0	10-1500-16
18,0	10-1500-18
20,0	10-1500-20

cm	
13,0	10-1600-13
14,0	10-1600-14
16,0	10-1600-16

cm	TREVES
12,5	10-1650-13
15,0	10-1650-15
18,0	10-1650-18

cm	TREVES
12,5	10-1660-13
15,0	10-1660-15
18,0	10-1660-18



für Hornhaut
 for cornea
 pour cornea
 para córnea
 per cornea

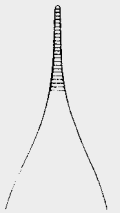

cm	THORPE
12,0	10-1698-12

cm	ADSON		
12,0	10-1700-12	10-1701-12	10-1704-12
15,0	10-1700-15	10-1701-15	10-1704-15
18,0	10-1700-18		

cm	EWALD (HUDSON)
12,0	10-1702-12

cm	ADSON micro
12,0	10-1706-12
15,0	10-1706-15



10-1400-11

10.4

Mit TC-Einsätzen
 TC Lined
 A mors TC
 Con bocas TC
 Con morso TC

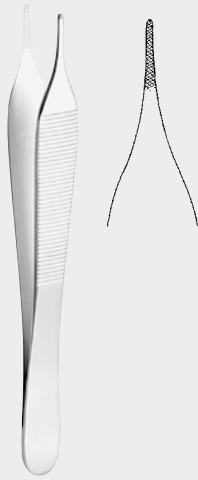

cm ADSON
 12,0 10-1708-12

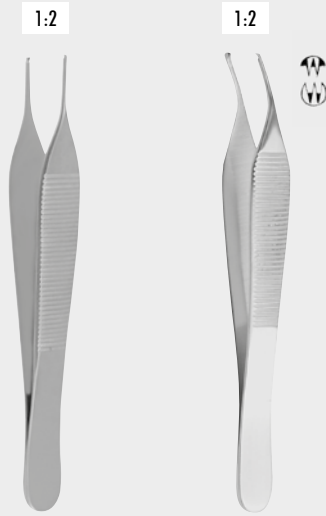

cm ADSON
 12,0 10-1800-12 10-1804-12 10-1801-12 10-1803-12
 15,0 10-1800-15 10-1804-15 10-1801-15
 18,0 10-1800-18



cm EWALD (HUDSON)
 12,0 10-1802-12

PINZETTEN

FORCEPS

PINCES

PINZAS

PINZE



cm ADSON micro
 12,0 10-1806-12
 15,0 10-1806-15
 12,0 10-1810-12
 15,0 10-1810-15



cm ADSON-BROWN
 12,0 10-1808-12
 12,0 10-1812-12
 15,0 10-1812-15



cm BROWN
 12,0 10-1809-12
 16,0 10-1809-16
 20,0 10-1809-20
 25,0 10-1809-25



10-1809-12

10.5

PINZETTEN

FORCEPS

PINCES

PINZAS

PINZE

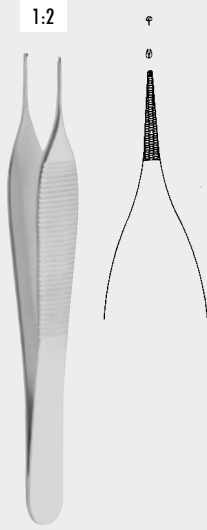

cm ADSON
12,0 10-1816-12

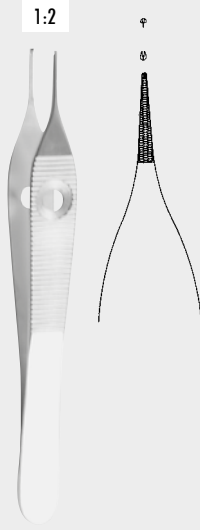

cm ADSON
12,0 10-1822-12

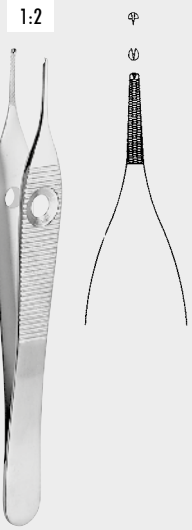

cm ADSON
12,0 10-1824-12

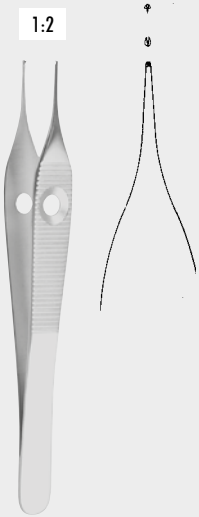

cm ADSON
12,0 10-1826-12



cm ADSON
12,0 10-1828-12
15,0 10-1828-15



cm JEFFERSON
18,0 10-1829-18



cm JEFFERSON
18,0 10-1830-18

Mit TC-Einsätzen
 TC Lined
 A mors TC
 Con bocas TC
 Con morso TC



cm GRAEFFE
 10,5 10-1900-10



cm
 20,0 10-1941-20



cm CUSHING
 20,0 10-1950-20



cm	CUSHING
17,0	10-2200-17
20,0	10-2200-20



PINZETTEN

FORCEPS

PINCES

PINZAS

PINZE



cm	CUSHING
17,0	10-2300-17
	10-2301-17

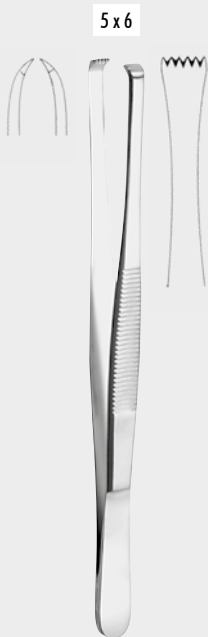

cm LERCHE
 15,0 10-2302-15

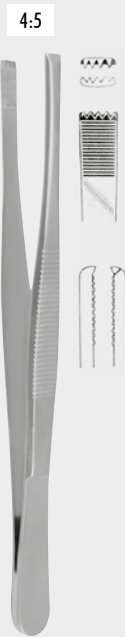

cm	ADLERKREUTZ
15,0	10-2306-15
20,0	10-2306-20
25,0	10-2306-25



cm	ADLERKREUTZ fino
15,0	10-2308-15
20,0	10-2308-20



10-2308-20

10.7



Mit TC-Einsätzen
 TC Lined
 A mors TC
 Con bocas TC
 Con morso TC

PINZETTEN

FORCEPS

PINCES

PINZAS

PINZE

1:2



cm	LANE
14,5	10-2400-14
18,0	10-2400-18
20,0	10-2400-20

2:3



cm	LANE
14,5	10-2402-14
18,0	10-2402-18
20,0	10-2402-20

1:2



cm	FERRIS-SMITH
18,0	10-2406-18
18,0	10-2410-18

2:3



cm	FERRIS-SMITH
18,0	10-2408-18
18,0	10-2420-18

1:2



cm	BONNEY
18,0	10-2422-18
18,0	10-2426-18

2:3



cm	BONNEY
18,0	10-2424-18



10-2400-14

10.8

Mit TC-Einsätzen
 TC Lined
 A mors TC
 Con bocas TC
 Con morso TC



cm **BONNEY**
 18,0 10-2428-18
 18,0 10-2430-18



cm **JEANS**
 14,0 10-2432-14



cm **JEANS**
 14,0 10-2434-14
 18,0 10-2434-18



cm **RAMSAY**
 18,0 10-2440-18



cm **RAMSAY**
 18,0 10-2442-18



cm **RAMSAY**
 18,0 10-2444-18

PINZETTEN

FORCEPS

PINCES

PINZAS

PINZE



cm **TURN-OVER**
 13,0 10-2448-13
 15,0 10-2448-15
 18,0 10-2448-18



cm **DUVAL**
 14,5 10-2500-14



cm **COLLIN-DUVAL**
 20,0 10-2502-20



cm **Russ. Mod.**
 15,0 10-2506-15
 20,0 10-2506-20
 25,0 10-2506-25



cm **MAYO RUSS.**
 23,0 10-2508-23



10-2508-23

10.9



Mit TC-Einsätzen
 TC Lined
 A mors TC
 Con bocas TC
 Con morso TC

PINZETTEN

FORCEPS

PINCES

PINZAS

PINZE

6:7



cm	DURANTE
14,5	10-2510-14
16,0	10-2510-16
20,0	10-2510-20
25,0	10-2510-25



cm	McINDOE
15,0	10-2518-15
15,0	10-2520-15

1:2



cm	McINDOE
15,0	10-2524-15

2:3



cm	SEMKEN
12,5	10-2598-12



cm	SEMKEN
12,5	10-2600-12
15,5	10-2600-15



cm	SEMKEN
12,5	10-2601-12
15,5	10-2601-15



cm	SEMKEN
15,5	10-2694-15
18,5	10-2694-18

1 x 2



cm	SEMKEN
15,5	10-2696-15
18,5	10-2696-18

1:2



cm	SEMKEN
12,5	10-2700-12
15,5	10-2700-15

1:2



cm	SEMKEN
12,5	10-2701-12
15,5	10-2701-15



10-2510-14

10.10

Mit TC-Einsätzen
 TC Lined
 A mors TC
 Con bocas TC
 Con morso TC



1:2



cm GILLIES
 15,5 10-2702-15
 15,5 10-2703-15



cm TAYLOR
 17,0 10-2704-17 10-2705-17

PINZETTEN

FORCEPS

PINCES

PINZAS

PINZE

1:2



cm TAYLOR
 17,0 10-2706-17 10-2707-17

1:2



cm TAYLOR
 17,0 10-2714-17

cm TAYLOR
 17,0 10-2716-17

mit Schaberende
 with dissector end
 à rugine
 con rascador
 con estremita a forma di rugine



10-2716-17

10.11



Mit TC-Einsätzen
 TC Lined
 A mors TC
 Con bocas TC
 Con morso TC

PINZETTEN

FORCEPS

PINCES

PINZAS

PINZE

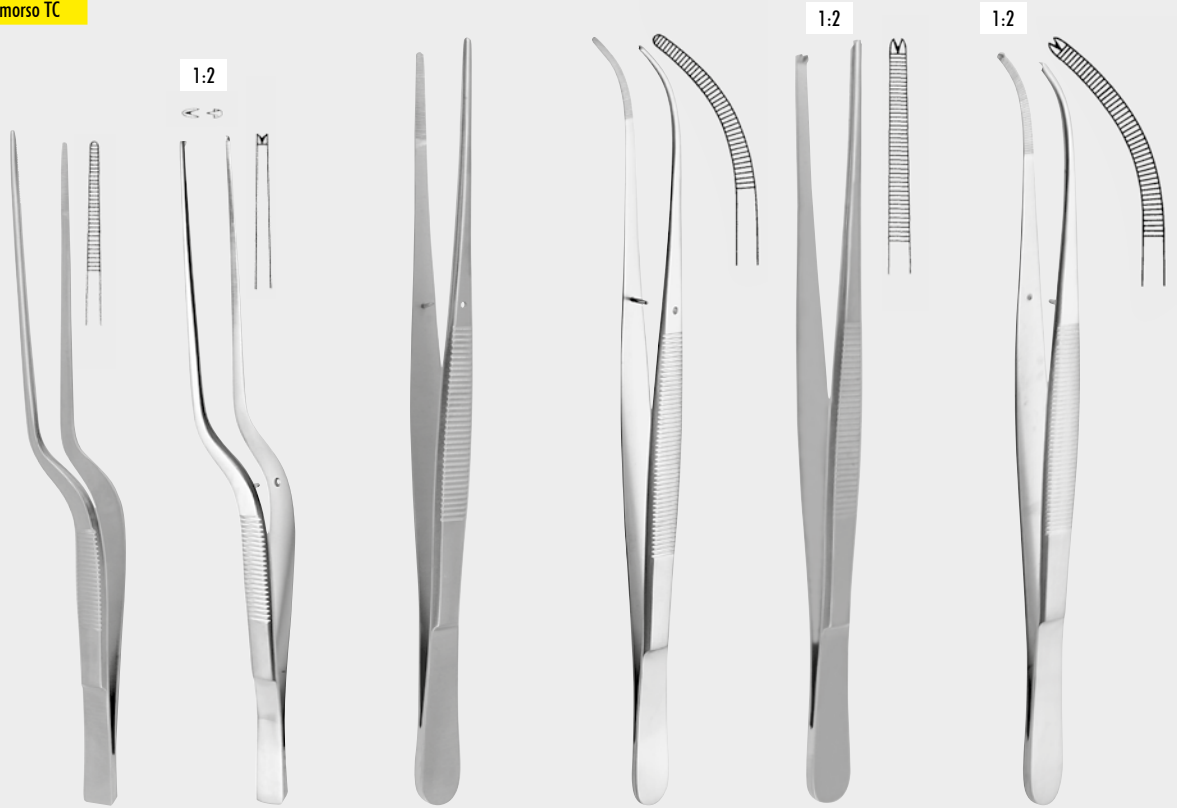

cm	TAYLOR	cm	TAYLOR	cm	BROPHY	cm	BROPHY
17,0	10-2721-17	17,0	10-2723-17	20,0	10-2808-20	20,0	10-2900-20
17,0	10-2722-17				10-2809-20		10-2901-20

mit Schaberende
 with dissector end
 à rugine
 con rascador
 con estremita a forma di rugine

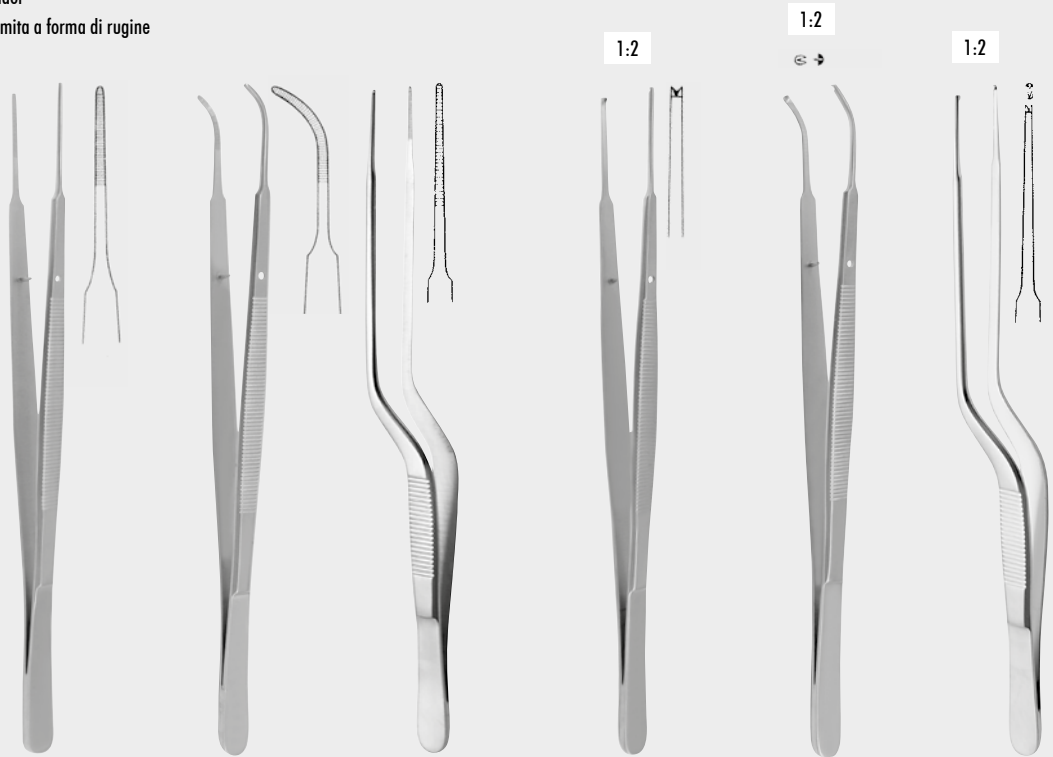

cm	GERALD	cm	GERALD	cm	GERALD	cm	GERALD	cm	GERALD
18,0	10-3002-18	18,0	10-3003-18	18,0	10-3005-18	18,0	10-3100-18	18,0	10-3101-18
23,0	10-3002-23					23,0	10-3100-23		18,0
18,0	10-3006-18					18,0	10-3105-18		18,0



10-2721-18

10.12

Mit TC-Einsätzen
 TC Lined
 A mors TC
 Con bocas TC
 Con morso TC



1:2



cm WAUGH
 15,0 10-3112-15
 20,0 10-3112-20



cm WAUGH
 15,0 10-3114-15
 18,0 10-3114-18
 20,0 10-3114-20
 25,0 10-3114-25
 30,5 10-3114-30



cm BROWN-RESANO
 20,0 10-3116-20
 25,0 10-3116-25
 30,0 10-3116-30



cm DE MARTEL
 15,0 10-3118-15
 20,0 10-3118-20
 25,0 10-3118-25

PINZETTEN

FORCEPS

PINCES

PINZAS

PINZE

6:7

1:2



cm DE MARTEL
 15,0 10-3120-15
 20,0 10-3120-20
 25,0 10-3120-25



cm FARKAS
 15,0 10-3122-15
 18,0 10-3122-18



cm SINGLE-TUTTLE
 18,0 10-3200-18
 23,0 10-3200-23



cm NELSON
 15,0 10-3202-15
 18,0 10-3202-18
 23,0 10-3202-23



cm
 15,0 10-3204-15

glatt
 smooth
 lisse
 liso
 liscia



10-3204-15

10.13

Mit TC-Einsätzen
 TC Lined
 A mors TC
 Con bocas TC
 Con morso TC

PINZETTEN

FORCEPS

PINCES

PINZAS

PINZE



cm	WANGENSTEEN	
15,0		10-3214-15
23,0	10-3210-23	10-3214-23
25,0		10-3214-25

3:4



cm	STILLE BARRAYA	
18,0		10-3220-18
20,0		10-3220-20
25,0		10-3220-25



cm	DENIS BROWNE	
18,0		10-3224-18

ZEPF[®]
α
 INSTRUMENTS

10-3210-23

10.14

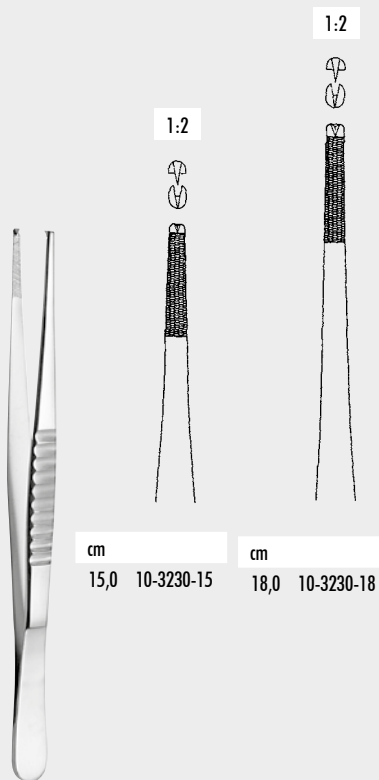

cm
15,0 10-3230-15

cm
18,0 10-3230-18



cm STONE
15,0 10-3234-15



cm DUEHRSEN
20,0 10-3240-20

PINZETTEN

FORCEPS

PINCES

PINZAS

PINZE



cm MAINGOT
28,0 10-3244-28



cm JACKSON BURROWS
14,0 10-3246-14



mm CAIRNS DOTT 18,0 cm
1,0 10-3248-18



cm OFFICER
15,0 10-3250-15



cm KÜHNE
10,5 10-3299-10

ZEPF[®]
&
INSTRUMENTS

10-3299-10
10.15

PINZETTEN



cm #3
12,0 10-3300-12



cm #3C
11,0 10-3300-31



cm #7
11,5 10-3301-12



cm #1
12,0 10-3302-01



cm #4
11,0 10-3302-04

FORCEPS

PINCES

PINZAS

PINZE



cm #5
11,0 10-3302-05



cm #6
11,0 10-3303-11



mm 15,5 cm
0,6 10-3306-06
0,8 10-3306-08
1,0 10-3306-10

1:2



mm 15,5 cm
0,6 10-3308-06
0,8 10-3308-08
1,0 10-3308-10



cm
10,0 10-3310-10



cm
10,0 10-3311-10



cm
10,0 10-3313-10

PINZETTEN

FORCEPS

PINCES

PINZAS



cm
10,0 10-3314-10



cm
10,0 10-3315-10



cm
10,0 10-3317-10

PINZE



Mit TC-Einsätzen
TC Lined
A mors TC
Con bocas TC
Con morso TC

Für Naht - for Suture - pour suture - para sutura - per sutura

1:2



cm
11,0 10-3320-11



cm
15,0 10-3406-15



cm
15,0 10-3408-15



cm
15,0 10-3409-15

PINZETTEN

FORCEPS

PINCES

PINZAS

PINZE



cm
20,0 10-3410-20



cm CHARNLEY
18,0 10-3412-18



cm OBWEGESER
16,0 10-3414-16
18,0 10-3414-18



cm MUSTARDE
15,0 10-3416-15



10-3416-15

10.18



glatt
smooth
lisse
liso
liscia



Splinter-Pinzetten
Splinter Forceps
Pincès à écharde
Pinzas para espinas
Pinze per schegge

cm	
8,0	10-8002-08
9,0	10-8002-09
10,5	10-8002-10
11,5	10-8002-11
12,5	10-8002-12
14,5	10-8002-14

cm	
8,0	10-8003-08
9,0	10-8003-09
10,0	10-8003-10
11,0	10-8003-11
12,0	10-8003-12

cm	
10,5	10-8004-10

cm	
12,5	10-8006-12

cm	FEILCHENFELD
7,5	10-8100-07
9,0	10-8100-09
11,5	10-8100-11

PINZETTEN

FORCEPS

PINCES

PINZAS

PINZE

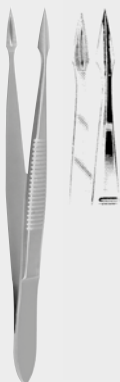

cm	HUNTER
10,5	10-8102-10

cm	HUNTER
10,5	10-8103-10

cm	
12,5	10-8105-12

cm	CARMALT
10,5	10-8106-10

cm	CARMALT
10,5	10-8107-10



10-8107-10
10.19

Splitter-Pinzetten
 Splinter Forceps
 Pincès à échardes
 Pinzas para espinas
 Pinze per schegge



cm PEET
 11,5 10-8201-11

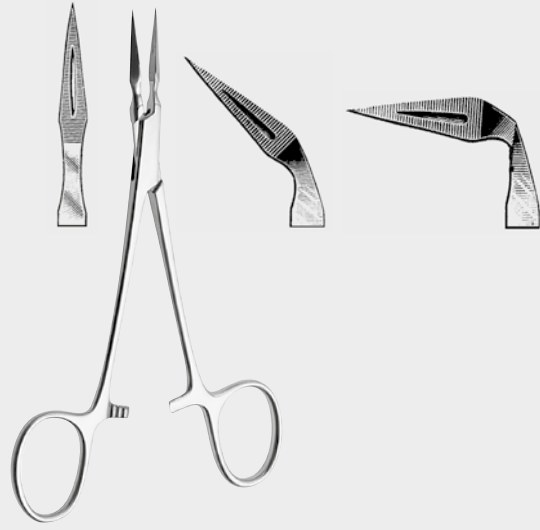

cm	STIEGLITZ (WILLIAMS)		
		45°	90°
13,5	10-8202-13	10-8203-13	10-8203-90

PINZETTEN

FORCEPS

PINCES

PINZAS

PINZE

Zecken Entfernungspinzette
 Tick removal forceps
 Pince pour extraire les tiques
 Pinza para extraer garrapatas
 Pinze per estrazione di zecche

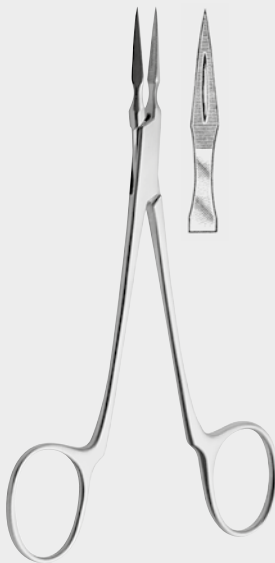

cm ARCHER
 14,0 10-8204-14 10-8205-14



cm PHYSICIAN
 13,0 10-8206-13



cm VIRTUS (RALK)
 15,0 10-8208-15 10-8209-15



cm
 11,5 10-8409-11

PINZETTEN

FORCEPS

PINCES

PINZAS

PINZE



Mikrochirurgie-Pinzetten
 Microsurgery Forceps
 Pincès à microchirurgie
 Pinzas para microcirugía
 Pinze per microchirurgia

PINZETTEN

FORCEPS

PINCES

PINZAS

PINZE

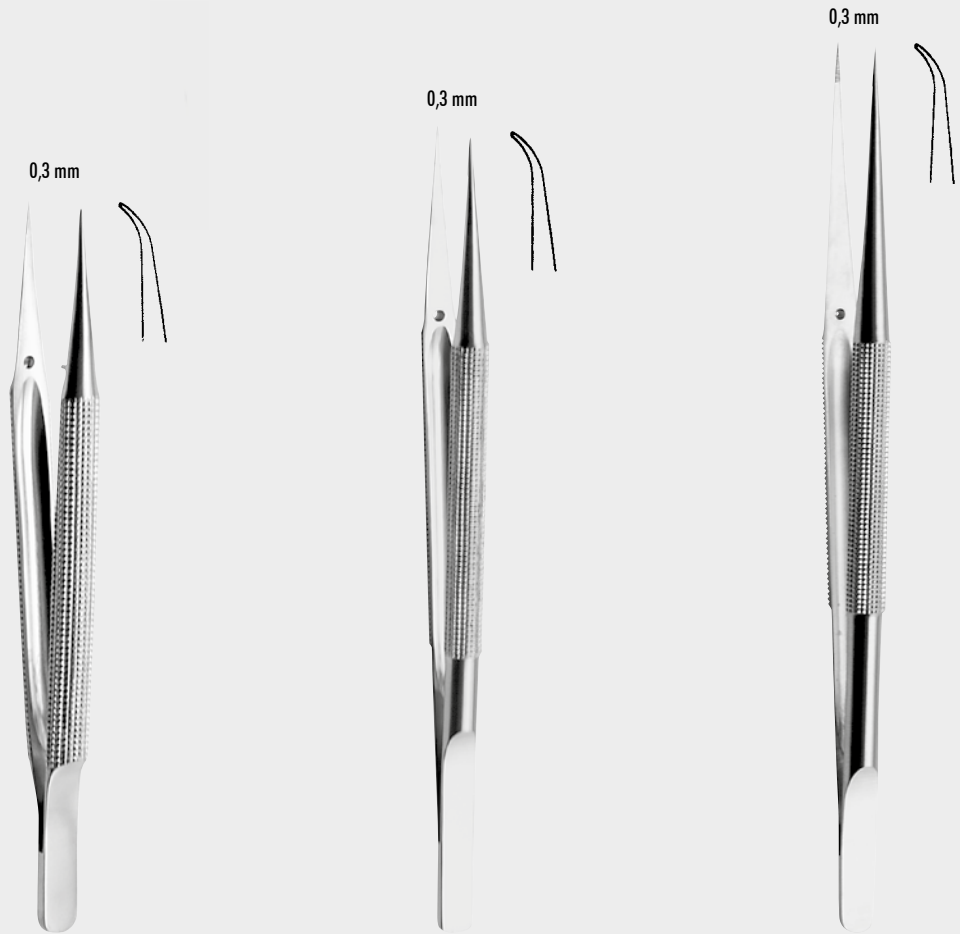

cm		
12,0	11-1002-12	11-1003-12

cm		
15,0	11-1004-15	11-1005-15

cm		
18,0	11-1008-18	11-1009-18
23,0	11-1008-23	



11-1002-12

11.2

Mikrochirurgie-Pinzetten
 Microsurgery Forceps
 Pincès à microchirurgie
 Pinzas para microcirugía
 Pinze per microchirurgia

PINZETTEN

FORCEPS

PINCES

PINZAS

PINZE

0,3 mm



cm VISE —
 13,5 11-1300-13

0,3 mm



cm VISE —
 13,5 11-1301-13

0,3 mm



cm —
 12,0 11-1302-12

0,8 mm



cm VISE —
 14,0 11-1304-14



cm BROCK —
 15,0 11-1400-15
 18,0 11-1400-18



11-1400-15

11.3



Atraumatische Pinzetten
 Atraumatic Tissue Forceps
 Pinces atraumatiques
 Pinzas atraumáticas
 Pinze atraumatiche

PINZETTEN

FORCEPS

PINCES

PINZAS

PINZE



cm	
16,0	11-3002-16
20,0	11-3002-20
24,0	11-3002-24



cm	DE BAKEY
16,0	11-3004-16
20,0	11-3004-20
24,0	11-3004-24
30,0	11-3004-30
35,0	11-3004-35

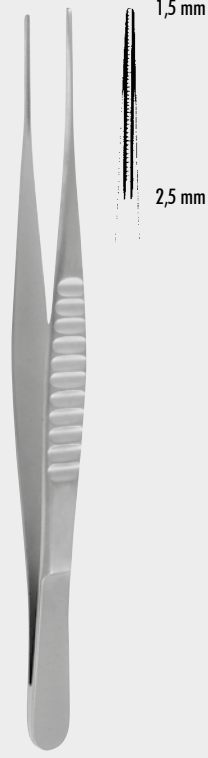

cm	DE BAKEY
16,0	11-3006-16
20,0	11-3006-20
24,0	11-3006-24
30,0	11-3006-30



cm	DE BAKEY
16,0	11-3008-16
20,0	11-3008-20
24,0	11-3008-24
30,0	11-3008-30
35,0	11-3008-35



cm	DE BAKEY
16,0	11-3009-16
20,0	11-3009-20
24,0	11-3009-24
30,0	11-3009-30



cm	DE BAKEY
16,0	11-3100-16
20,0	11-3100-20
24,0	11-3100-24
30,0	11-3100-30
35,0	11-3100-35



cm	COOLEY
16,0	11-3104-16
20,0	11-3104-20
24,0	11-3104-24



11-3002-16

11.4

Titan
Titanium
Titane
Titanio



cm	DE BAKEY-DIETHRICH
16,0	11-3106-16
20,0	11-3106-20
24,5	11-3106-24



cm	DE BAKEY
16,0	11-3110-16
20,0	11-3110-20
24,0	11-3110-24



cm	1,5 mm	1,8 mm
16,0	11-3110-16	11-3112-16
20,0	11-3110-20	11-3112-20
24,0	11-3110-24	11-3112-24

Atraumatiche Pinzetten
Atraumatic Tissue Forceps
Pinces atraumatiques
Pinzas atraumáticas
Pinze atraumatiche

PINZETTEN

FORCEPS

PINCES

PINZAS

PINZE



cm	DE BAKEY
15,0	11-3202-15
20,0	11-3202-20
24,0	11-3202-24



cm	DE BAKEY
15,0	11-3204-15
20,0	11-3204-20
24,0	11-3204-24



cm	DE BAKEY
15,0	11-3302-15
20,0	11-3302-20
24,0	11-3302-24
30,0	11-3302-30



11-3302-30

11.5

Mit TC-Einsätzen
 TC Lined
 A mors TC
 Con bocas TC
 Con morso TC

Atraumatische Pinzetten
 Atraumatic Tissue Forceps
 Pincés atraumáticos
 Pinzas atraumáticas
 Pinze atraumatiche

PINZETTEN

FORCEPS

PINCES

PINZAS

PINZE



cm	DE BAKEY (CHITWOOD)
15,0	11-4002-15
19,5	11-4002-20
24,0	11-4002-24



DE BAKEY (CHITWOOD)
11-4004-15 - 11-4104-24

6:12

6:12



cm	1,5 mm	2,0 mm
15,0	11-4004-15	11-4006-15
19,0	11-4004-19	11-4006-19
24,0	11-4004-24	11-4006-24

6:12

2,7 mm



cm	DE BAKEY (CHITWOOD)
15,0	11-4104-15
19,0	11-4104-19
24,0	11-4104-24



11-4002-15

11.6



YASARGIL
11-5006-16 - 11-5100-18

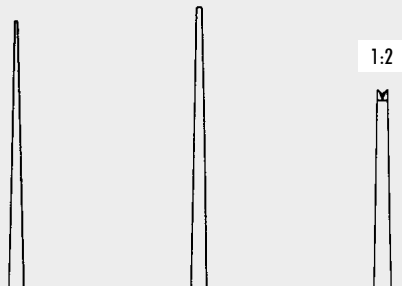

cm			
16,0	11-5006-16	11-5009-16	
18,0	11-5006-18	11-5009-18	11-5100-18
20,0	11-5006-20	11-5009-20	
22,0	11-5006-22	11-5009-22	
24,0	11-5006-24	11-5009-24	

Mikro Pinzetten
Micro Forceps
Pinces micro
Pinzas micro
Pinze micro

PINZETTEN

FORCEPS

PINCES

PINZAS

PINZE



YASARGIL / HEIFETZ
11-5103-22 - 11-5205-22

ø 3 mm ø 5 mm ø 7 mm



cm	YASARGIL	YASARGIL	YASARGIL-SAMII
22,0	11-5103-22	11-5105-22	
24,0	11-5103-24 (SAMII)	11-5105-24 (SAMII)	11-5107-24



cm — SAMII —
22,0 11-5109-22 11-5111-22

ø 3 mm ø 3 mm ø 5 mm ø 5 mm

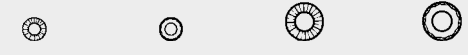

cm	YASARGIL	HEIFETZ	YASARGIL	HEIFETZ
22,0	11-5201-22	11-5202-22	11-5203-22	11-5205-22



11-5111-22

11.7

Tumor- und Gefäß-Pinzetten
 Tumor and Vessel Forceps
 Pincès à tumeurs et vasculaires
 Pinzas para tumores y vasculares
 Pinze per tumori e vascolari

PINZETTEN

FORCEPS

PINCES

PINZAS

PINZE

Atraumatische Pinzetten extra leicht
 Atraumatic Tissue Forceps extra light
 Pincès atraumatiques extra légères
 Pinzas atraumáticas extra ligeras
 Pinze atraumatiche extra leggere

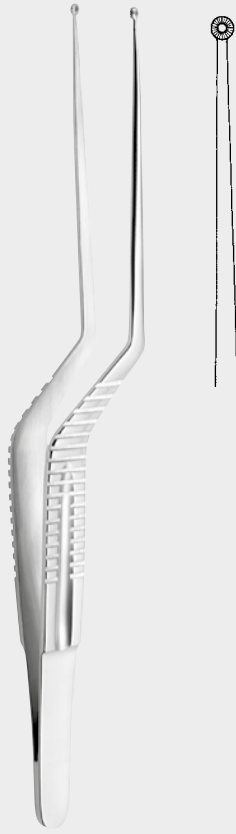

cm YASARGIL ø mm
 20,0 11-5206-20 3,0



cm HUNT ø mm
 20,0 11-5208-20 5,0



cm HUNT ø mm
 20,0 11-5209-20 5,0



cm
 16,0 11-5211-16



cm
 16,0 11-5213-16



cm 18,5 cm
 11-5214-01 11-5215-01
 11-5214-02

1,5 mm

1,2 mm

1,5 mm

1,5 mm



cm DE BAKEY
15,0 11-5220-15



cm DE BAKEY
20,0 11-5220-20



cm DE BAKEY
24,0 11-5220-24



cm DE BAKEY
30,0 11-5220-30

Atraumatische Pinzetten extra leicht
Atraumatic Tissue Forceps extra light
Pinces atraumatiques extra légères
Pinzas atraumáticas extra ligeras
Pinze atraumatiche extra leggere

PINZETTEN

FORCEPS

PINCES

PINZAS

PINZE



mm LAZAR 15,5 cm
0,5 11-5260-05
0,8 11-5260-08

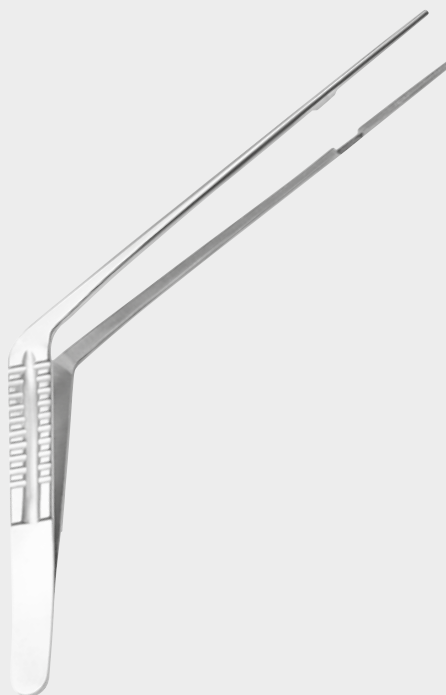

cm LANDOLT
21,5 11-5301-21

ZEPF®
INSTRUMENTS

11-5220-15 - 11-5301-21

11.9

PINZETTEN

FORCEPS

PINCES

PINZAS

PINZE

KLEMMEN

FORCEPS

PINCES

PINZAS

PINZE



Atrauma Bulldogklemmen
 Atrauma Bulldog Clamps
 Clamps Bulldog Atrauma
 Clamps Atrauma Bulldog
 Pinze Atrauma Bulldog

KLEMMEN

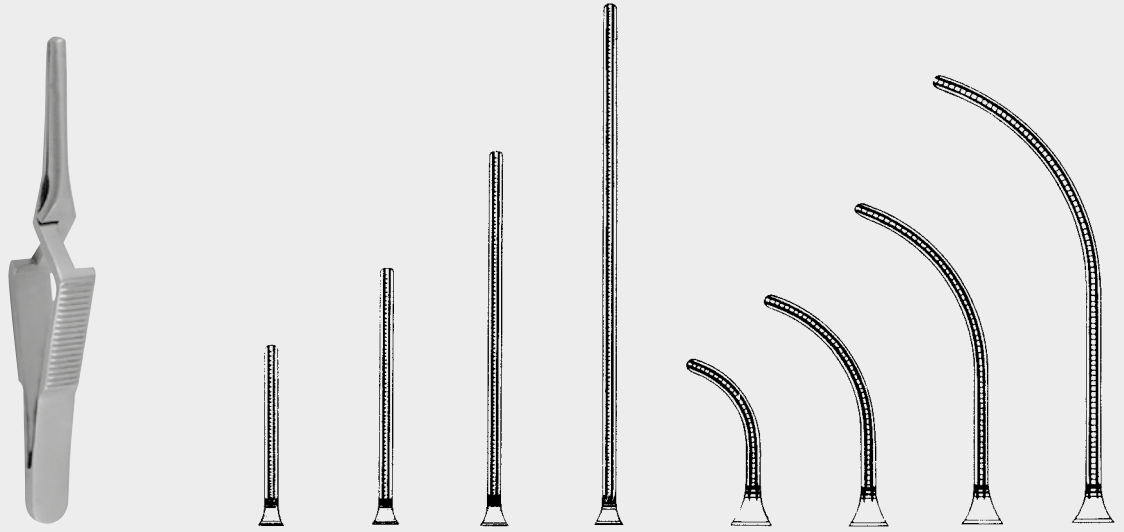

DE BAKEY
 12-0902-07 - 12-0903-12

12-0902-07
 7,5 cm

12-0902-08
 8,5 cm

12-0902-10
 10,5 cm

12-0902-12
 12,0 cm

12-0903-07
 7,5 cm

12-0903-08
 8,5 cm

12-0903-10
 10,5 cm

12-0903-12
 12,0 cm

FORCEPS

PINCES

PINZAS

PINZE



Anlegezange
 Applying Forceps
 Pince à poser les clamps Bulldog
 Pinza para poner los clamps Bulldog
 Pinza per posizionare pinze Bulldog



mm	— GLOVER mini	—
3,5	12-0904-35	12-0905-35
4,5	12-0904-45	12-0905-45
5,0	12-0904-50	12-0905-50

cm
 23,0 12-0901-23

Atrauma Bulldogklemmen
 Atrauma Bulldog Clamps
 Clamps Bulldog Atrauma
 Clamps Atrauma Bulldog
 Pinze Atrauma Bulldog



GLOVER
 12-0906-06 - 12-0907-11



12-0906-06
 6,0 cm



12-0906-07
 7,0 cm



12-0906-09
 9,0 cm



12-0906-11
 11,0 cm

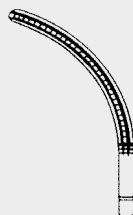

12-0907-06
 5,5 cm



12-0907-07
 6,5 cm

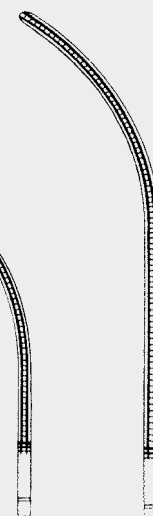

12-0907-09
 8,5 cm



12-0907-11
 10,5 cm

KLEMMEN

FORCEPS

PINCES

PINZAS

PINZE



DE BAKY DIETRICH
 L= mm
 10 12-0908-10
 14 12-0908-14
 20 12-0908-20



DE BAKY DIETRICH
 L= mm
 10 12-0909-10
 14 12-0909-14
 20 12-0909-20



DEBAKEY SATINSKY
 cm
 7,0 12-0909-07



DEBAKEY SATINSKY
 cm
 9,0 12-0911-09



DEBAKEY SATINSKY
 cm
 9,0 12-0913-10



GLOVER
 cm
 5,5 12-0915-06

Tonsillen-Klemmen
Tonsil Forceps
Pincès à amygdales
Pinzas para amígdalas
Pinze per tonsille

KLEMMEN

FORCEPS

PINCES

PINZAS

PINZE

Arterienklemmen
Hemostatic Forceps
Pincès hémostatiques
Pinzas hemostáticas
Pinze emostatiche



12-4165-24

12.21



cm **NEGUS**
19,0 12-4135-19 12-4137-19



cm **OVERHOLT BABY**
13,0 12-4149-13



cm **FRASER KELLY (Crile)**
18,0 12-4149-18

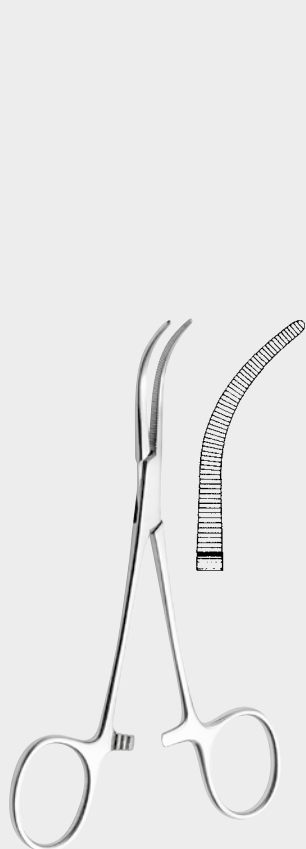

cm **OVERHOLT BABY**
14,0 12-4151-14



KELLY
12-4161-19 - 12-4165-24

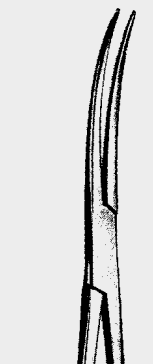

cm	
19,0	12-4161-19
22,0	12-4161-22
24,0	12-4161-24
Fig. 1	



cm	
19,0	12-4163-19
22,0	12-4163-22
24,0	12-4163-24
Fig. 2	



cm	
19,0	12-4165-19
22,0	12-4165-22
24,0	12-4165-24
Fig. 3	



Präparier- und Ligaturklemmen
 Dissecting and Ligature Forceps
 Pinces à dissection et passe-fils
 Pinzas para disección y pasahilos
 Pinze per dissezione e passafili

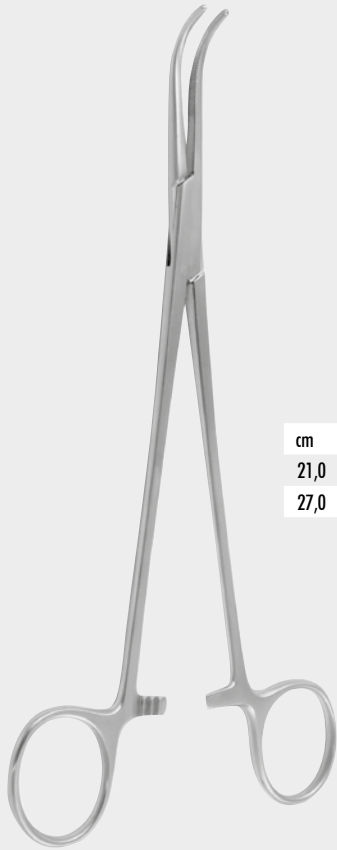

KLEMMEN

FORCEPS

PINCES

PINZAS

PINZE

cm	Fig. 1	Fig. 2	Fig. 3	Fig. 4	Fig. 5	Fig. 6	Fig. 7
21,0	12-4201-01	12-4201-02	12-4201-03	12-4201-04	12-4201-05	12-4201-06	12-4201-07
27,0	12-4207-01	12-4207-02	12-4207-03	12-4207-04	12-4207-05	12-4207-06	12-4207-07

OVERHOLT-GEISSENDOERFER
 12-4201-01 - 12-4207-08



OVERHOLT „S“ Form
 12-4209-18 - 12-4209-24

Fig. 1	12-4209-18	18,5 cm
Fig. 2	12-4209-20	20,5 cm
Fig. 3	12-4209-21	21,0 cm
Fig. 4	12-4209-22	21,5 cm
Fig. 5	12-4209-24	24,0 cm



12-4165-24

12.22

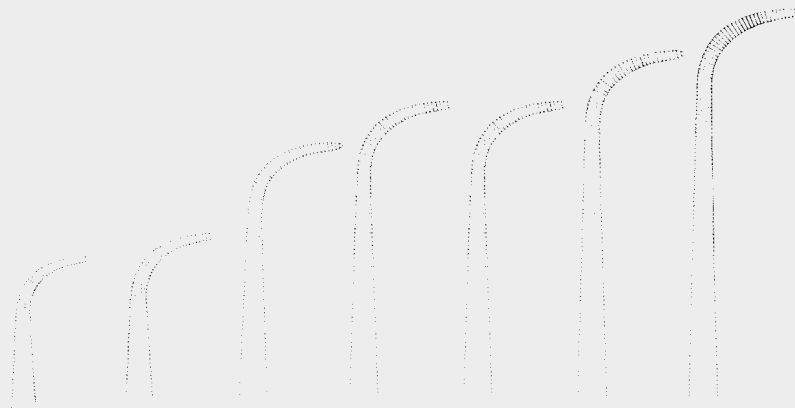

GEMINI	12-4301-13	12-4301-16	12-4301-18	12-4301-20	12-4301-23	12-4301-25	12-4301-28
cm	13,0	16,0	18,0	20,0	23,0	25,0	28,0

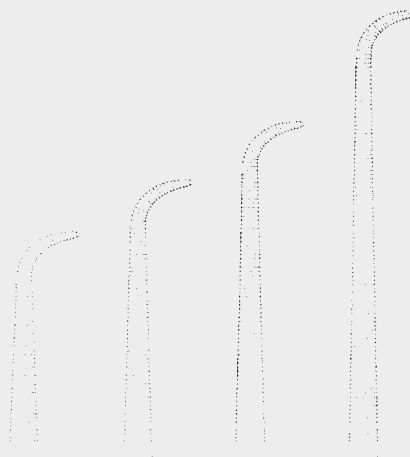

GEMINI mini	12-4303-18	12-4303-22	12-4303-25	12-4303-28
cm	18,0	22,0	25,0	28,0

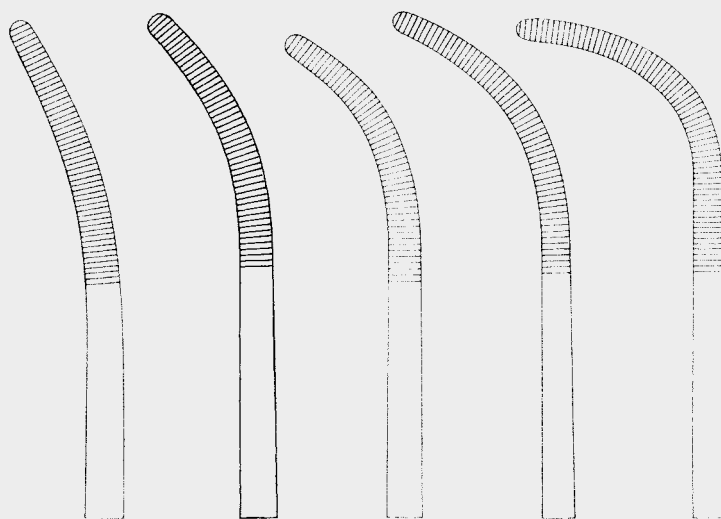

RUMEL 23,0 cm
12-4401-01 - 12-4401-05

12-4401-01	12-4401-02	12-4401-03	12-4401-04	12-4401-05
------------	------------	------------	------------	------------

Präparier- und Ligaturklemmen
Dissecting and Ligature Forceps
Pincers à dissection et passe-fils
Pinzas para disección y pasahilos
Pinze per dissezione e passafili

KLEMMEN

FORCEPS

PINCES

PINZAS

PINZE



12-4404-21

12.23



Arterienklemmen
 Hemostatic Forceps
 Pinces hémostatiques
 Pinzas hemostáticas
 Pinze emostatiche

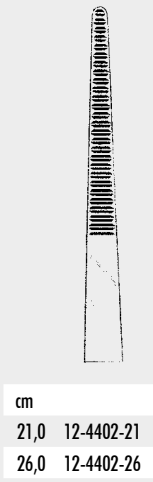

1:2



1:2

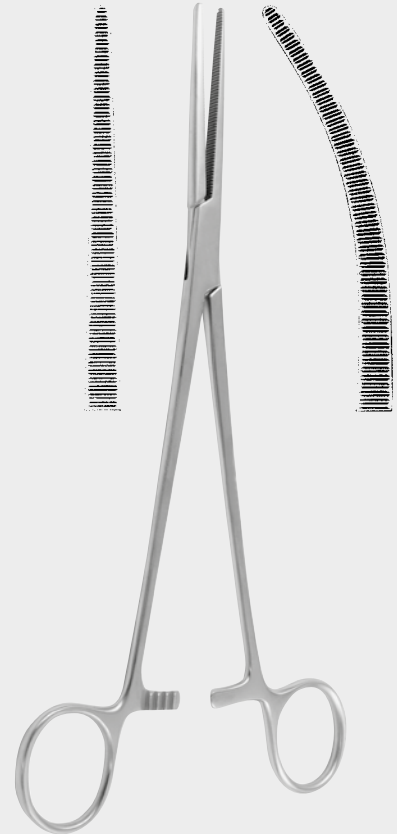
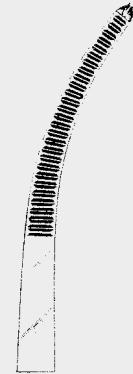
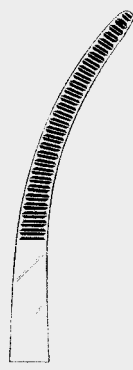

KLEMMEN

FORCEPS

PINCES

PINZAS

PINZE

Bronchusklemmen
 Bronchus Clamps
 Pinces-clamps à bronches
 Pinzas clamps bronquiales
 Pinze per bronchi

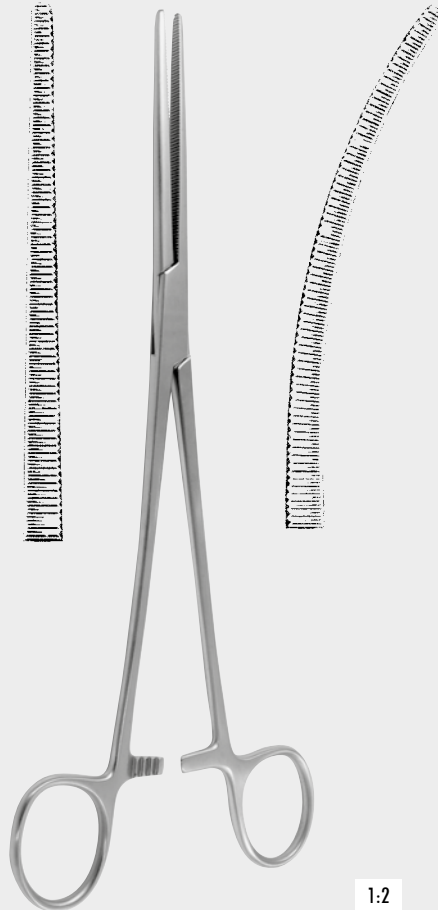

1:2

cm 24,0 12-4500-24

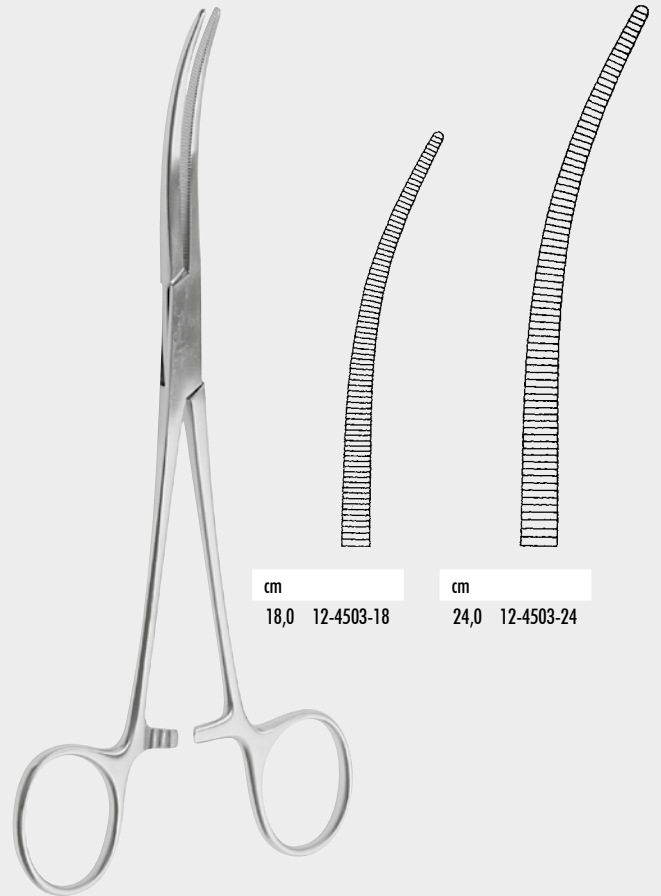

cm 18,0 12-4503-18

cm 24,0 12-4503-24



12-4401-05

12.24



12-4504-29

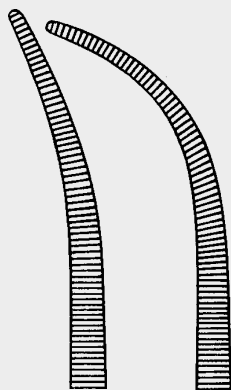

cm	Fig. 1	Fig. 2
29,5	12-4505-01	12-4505-02
35,5	12-4505-11	12-4505-12

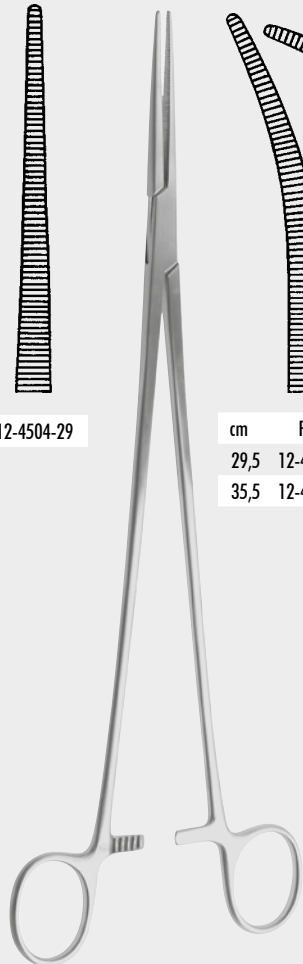

cm ZENKER
29,5 12-4504-29 - 12-4505-12

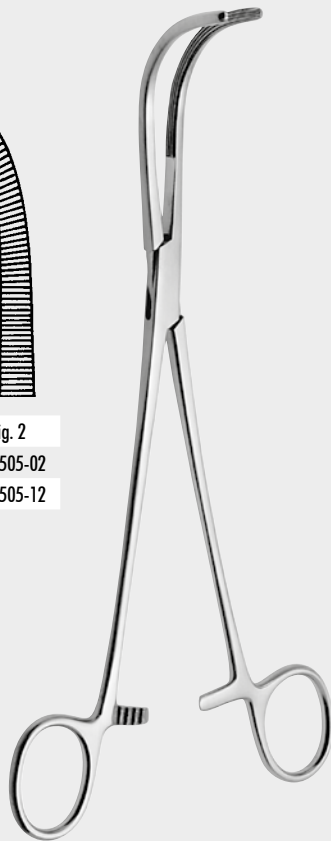

cm CRAFOORD SELLORS
24,0 12-4506-01



cm CRAFOORD SELLORS
24,0 12-4506-02

Präparier- und Ligaturklemmen
Dissecting and Ligature Forceps
Pinces à dissection et passe-fils
Pinzas para disección y pasahilos
Pinze per dissezione e passafili

KLEMMEN

FORCEPS

PINCES

PINZAS

PINZE



cm CRAFOORD SELLORS
24,0 12-4506-03



cm CRAFOORD modif.
24,0 12-4506-24



cm LAWRENCE
28,0 12-4507-28



cm MEEKER
18,0 12-4509-18
28,0 12-4509-28



12-4512-28

12.25

Arterienklemmen
 Hemostatic Forceps
 Pinces hémostatiques
 Pinzas hemostáticas
 Pinze emostatiche

KLEMMEN

FORCEPS

PINCES

PINZAS

PINZE

Präparier- und Ligaturklemmen
 Dissecting and Ligature Forceps
 Pinces à dissection et passe-fils
 Pinzas para disección y pasahilos
 Pinze per dissezione e passafili



cm **BRIDGE**
 28,0 12-4512-28 12-4513-28

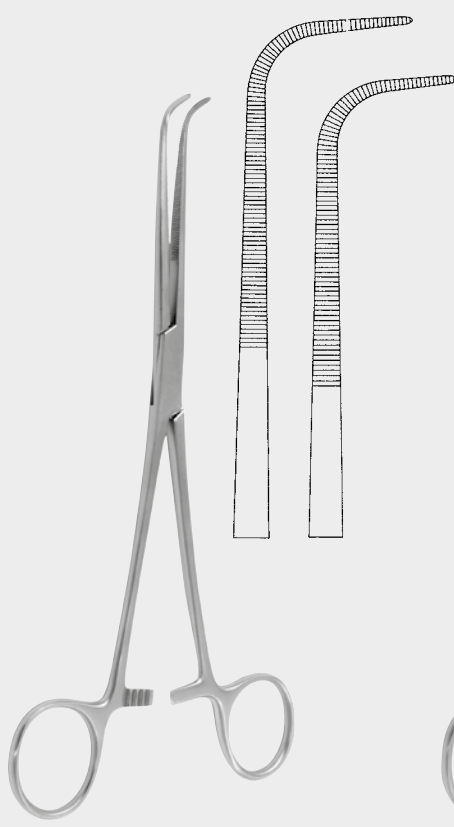

cm **WIKSTROEM**
 21,0 12-4521-21
 24,0 12-4521-24



cm **KANTROWITZ**
 19,0 12-4601-19
 24,0 12-4601-24
 28,0 12-4601-28

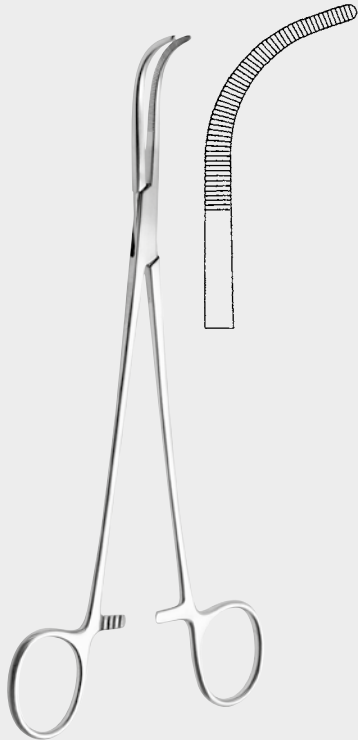

cm **MIXTER**
 23,0 12-4603-23



cm **MC QUIGG**
 22,0 12-4605-22

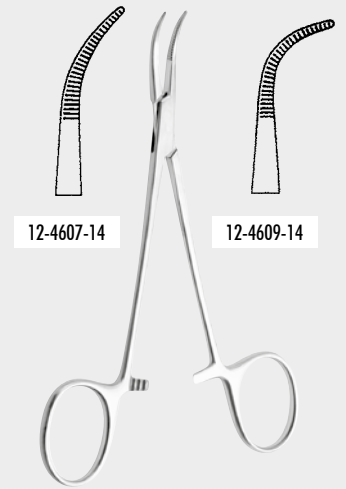

cm **MIXTER BABY**
 14,0 12-4607-14 - 12-4609-14

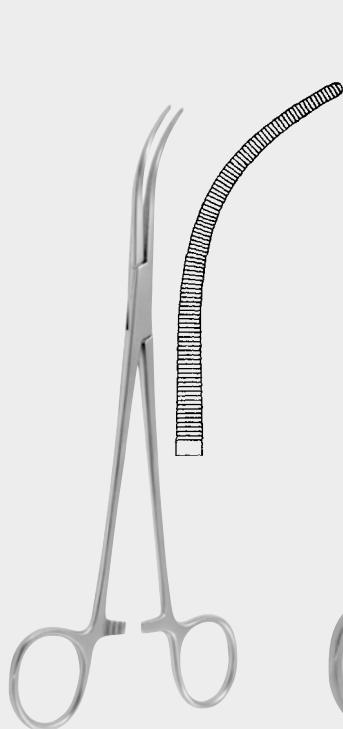

cm OVERHOLT-MIXTER
21,0 12-4691-21



cm MIXTER
14,0 12-4701-14
16,0 12-4701-16
18,0 12-4701-18
23,0 12-4701-23



cm MIXTER
22,0 12-4703-22



cm MIXTER Baby
14,0 12-4705-14



cm MIXTER Baby
18,0 12-4705-18



cm NISSEN
21,5 12-4706-21

Gallenkanal-Klemme
Gall Duct Forceps
Pince pour voies biliaires
Pinza para vías biliares
Pinze per vie biliari

Präparier- und Ligaturklemmen
Dissecting and Ligature Forceps
Pincès à dissection et passe-fils
Pinzas para disección y pasahilos
Pinze per dissezione e passafili

KLEMMEN

FORCEPS

PINCES

PINZAS

PINZE

Gallenkanal-Klemmen
 Gall Duct Forceps
 Pincés pour voies biliaires
 Pinzas para vías biliares
 Pinze per vie biliari

KLEMMEN



cm	MIXTER O'SHAUGNESSY
15,5	12-4707-15
19,0	12-4707-19



cm	MIXTER O'SHAUGNESSY
19,0	12-4708-19

FORCEPS

PINCES

PINZAS

PINZE



MIXTER
12-4709-22 - 12-4709-28



22,0 cm
12-4709-22

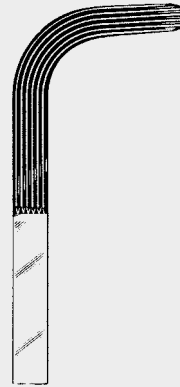

25,0 cm
12-4709-25

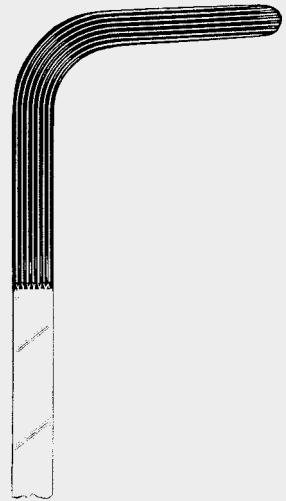

28,0 cm
12-4709-28



cm	O'SHAUGNESSY
15,0	12-4715-15
18,0	12-4715-18
20,0	12-4715-20
23,0	12-4715-23

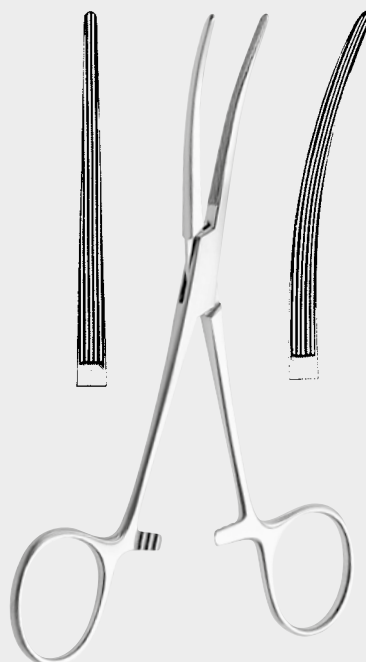

cm	BAINBRIDGE	
15,0	12-4800-15	12-4801-15
18,5	12-4800-18	12-4801-18

Gallenkanal-Klemmen
Gall Duct Forceps
Pincès pour voies biliaires
Pinzas para vías biliares
Pinze per vie biliari

KLEMMEN

FORCEPS

PINCES

PINZAS

PINZE



cm	LAHEY (SWEET)
23,0	12-4899-23



cm	LAHEY (SWEET)
19,0	12-4901-19

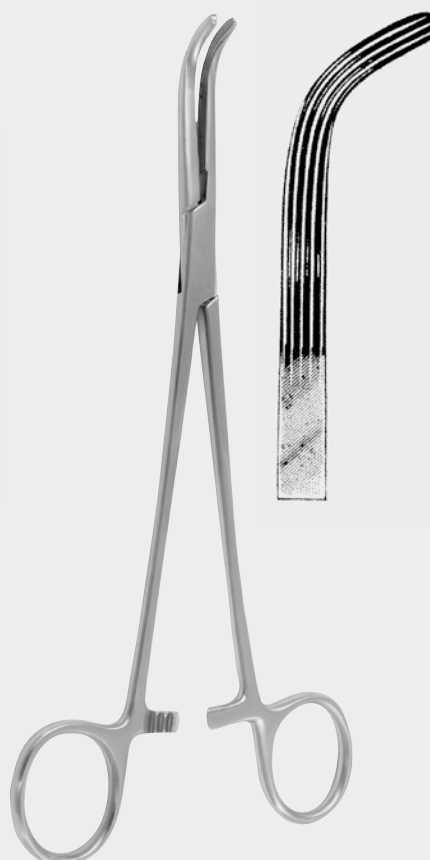

cm	LAHEY
23,0	12-4903-23
30,0	12-4903-30

ZEPF[®]
α
INSTRUMENTS

12-4903-30

12.29

Gallenkanal-Klemmen
 Gall Duct Forceps
 Pinces pour voies biliaires
 Pinzas para vías biliares
 Pinze per vie biliari

KLEMMEN

FORCEPS

PINCES

PINZAS

PINZE



cm LOWER
 18,0 12-4905-18



cm JOHN-HOPKINS
 20,0 12-4907-20



cm MIXTER
 16,5 12-4909-16

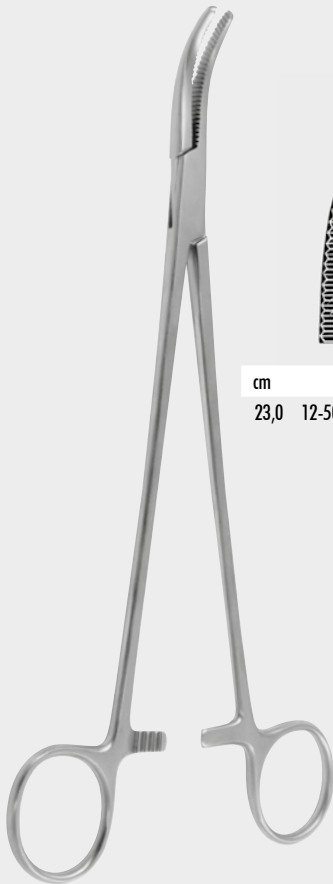

MOYNIHAN
 12-5001-23 - 12-5001-24



cm
 23,0 12-5001-23



cm
 24,0 12-5001-24



cm DESJARDINS
 21,0 12-5003-21



cm DESJARDINS
 21,0 12-5005-21

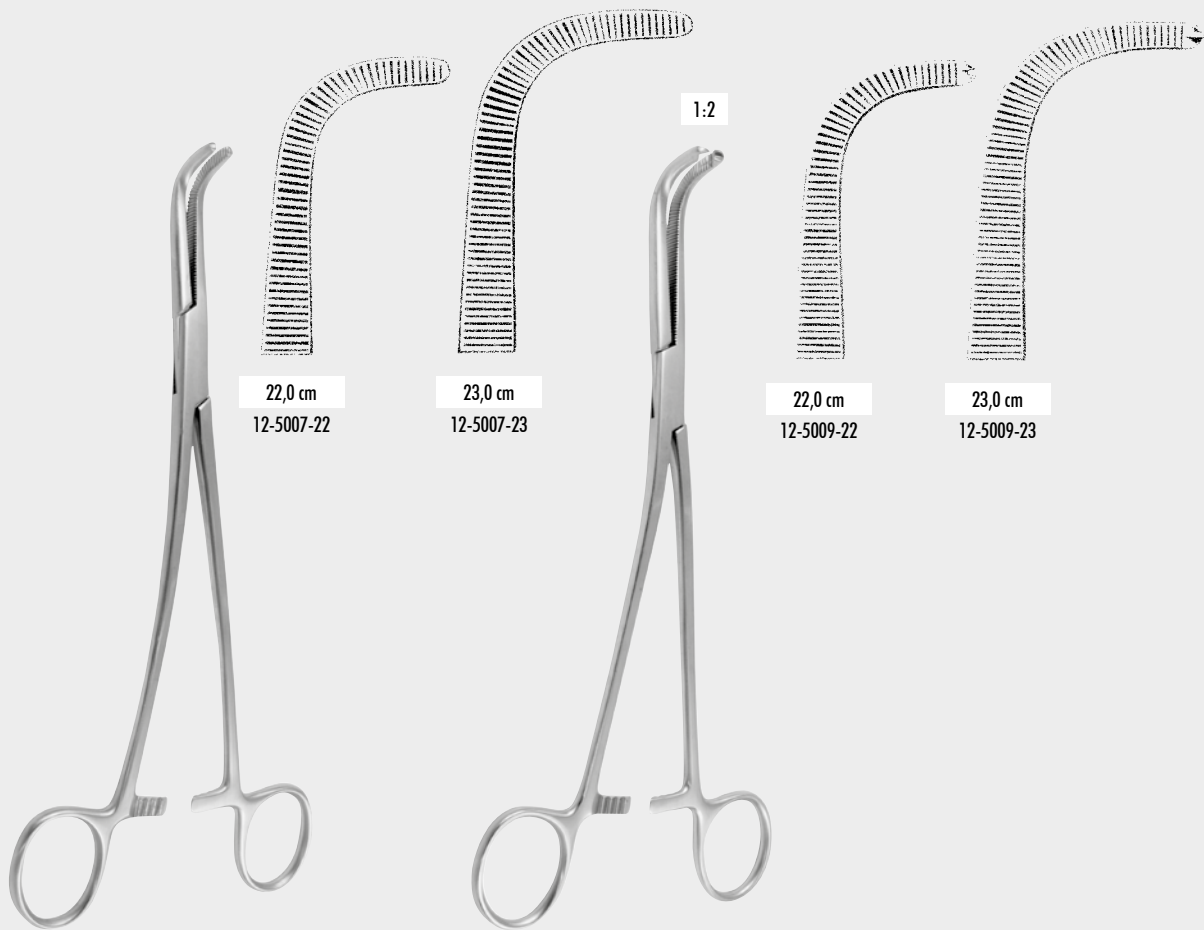

22,0 cm
12-5007-22

23,0 cm
12-5007-23

22,0 cm
12-5009-22

23,0 cm
12-5009-23

1:2

GRAY
12-5007-22 - 12-5007-23

GRAY
12-5009-22 - 12-5009-23

Cholecystektomie-Klemmen
Cholecystectomy Forceps
Pincès à cholecystectomie
Pinzas para colecistectomía
Pinze per colecistectomia

Nierenklemmen
Kidney Clamps
Pincès clamps rénales
Pinzas clamps renales
Pinze clamps renali

KLEMMEN

FORCEPS

PINCES

PINZAS

PINZE

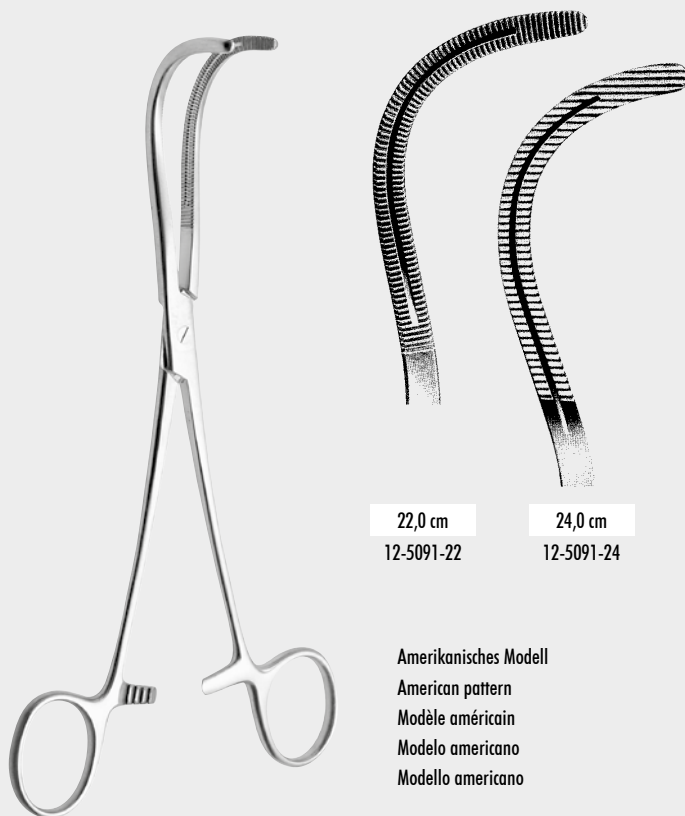

22,0 cm
12-5091-22

24,0 cm
12-5091-24

STILLE
12-5091-22 - 12-5091-24

Amerikanisches Modell
American pattern
Modèle américain
Modelo americano
Modello americano



12-5091-24

12.31

Nierenklemmen
 Kidney Clamps
 Pincés clamps rénales
 Pinzas clamps renales
 Pinze clamps renali

KLEMMEN

FORCEPS

PINCES

PINZAS

PINZE

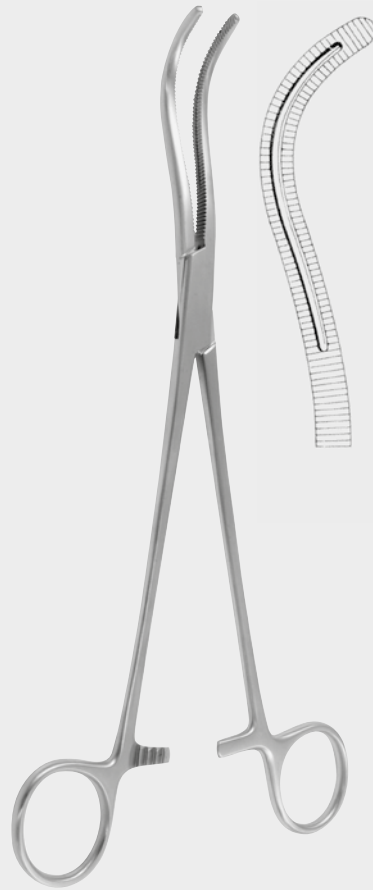

cm	STILLE
23,0	12-5103-23



cm	MAYO GUYON
23,0	12-5105-23



cm	GUYON
23,0	12-5107-23



GUYON
12-5109-20 - 12-5109-24

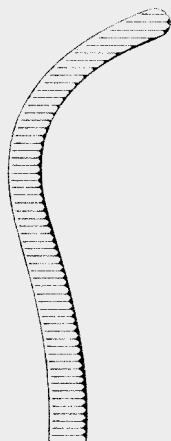

20,0 cm
12-5109-20

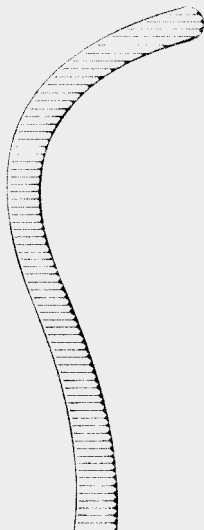

22,0 cm
12-5109-22

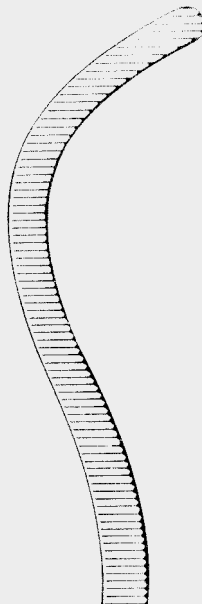

24,0 cm
12-5109-24

Nierenklemmen
Kidney Clamps
Pinces clamps rénales
Pinzas clamps renales
Pinze clamps renali

KLEMMEN

FORCEPS

PINCES

PINZAS

PINZE

atraumatisch
atraumatic
atraumatiques
atraumáticas
atraumatiche



cm GUYON
23,0 12-5114-23

atraumatisch
atraumatic
atraumatiques
atraumáticas
atraumatiche



cm GUYON
24,0 12-5114-24



12-5114-24

12.33



Nierenklemmen
 Kidney Clamps
 Pinces clamps rénales
 Pinzas clamps renales
 Pinze clamps renali

KLEMMEN

FORCEPS

PINCES

PINZAS

PINZE



cm HOSEMANN
 21,5 12-5116-21



cm HOSEMANN
 21,5 12-5118-21

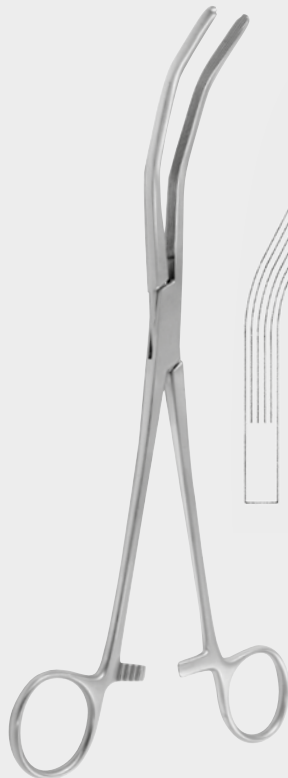

cm HERRICK
 23,0 12-5203-23



Uro-Tangential
 12-5221-01 - 12-5221-02

atraumatisch
 atraumatic
 atraumatique
 atraumática
 atraumatica

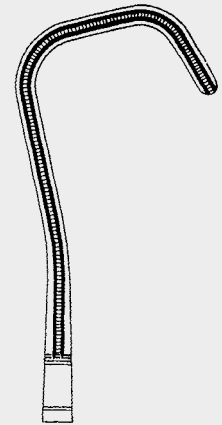

cm Fig. 1
 23,0 12-5221-01

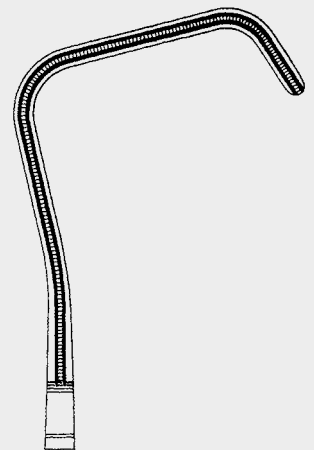

cm Fig. 2
 26,0 12-5221-02



12-5116-21

12.34

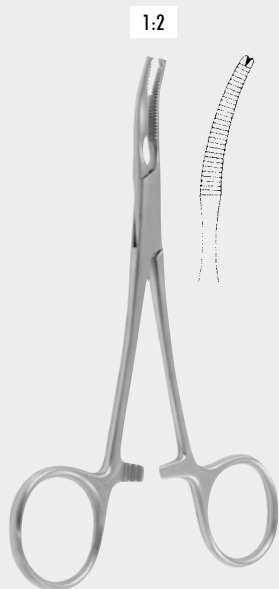

cm MIKULICZ
14,0 12-5481-14



cm MIKULICZ
18,0 12-5483-18



cm MIKULICZ
20,0 12-5485-20

Peritoneum Klemmen
Peritoneum Forceps
Pincés à péritoine
Pinzas para peritoneo
Pinze per peritoneo

KLEMMEN

FORCEPS

PINCES

PINZAS

PINZE



cm MIKULICZ
18,0 12-5487-18



cm MIKULICZ
20,0 12-5487-21



cm MIKULICZ
20,0 12-5489-20

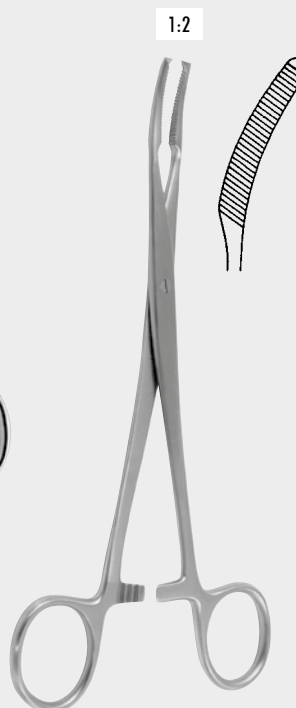

cm MIKULICZ
18,0 12-5493-18

ZEPF®
INSTRUMENTS

12-5493-18

12.35

Peritoneum Klemmen
Peritoneum Forceps
Pinces à péritoine
Pinzas para peritoneo
Pinze per peritoneo

KLEMMEN

FORCEPS

PINCES

PINZAS

PINZE

1:2



cm MIKULICZ
21,0 12-5495-21

1:2



cm MIKULICZ
24,5 12-5497-24

1:2



cm MIKULICZ
20,0 12-5501-20

1:2



cm MIKULICZ
20,0 12-5503-20



12-5495-21

12.36

Peritoneum Klemmen
Peritoneum Forceps
Pinces à péritoine
Pinzas para peritoneo
Pinze per peritoneo

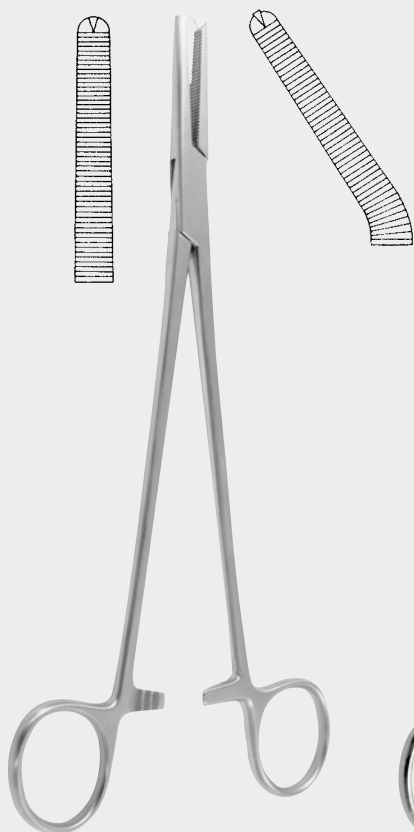

cm PHANEUF
21,0 12-5504-21 12-5505-21



cm SEGOND LANDAU
24,0 12-5508-24



cm SEGOND LANDAU
24,0 12-5509-24

KLEMMEN

FORCEPS

PINCES

PINZAS

PINZE

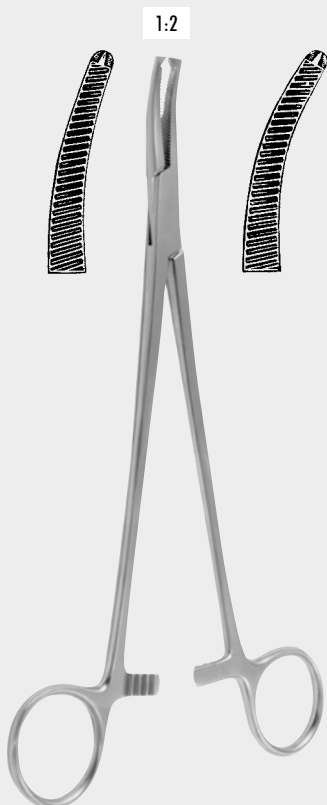

cm FAURE
20,0 12-5601-20 12-5603-20



cm FAURE
25,0 12-5605-25



cm
25,0 12-5687-25



cm WERTHEIM
24,0 12-5689-24



12-5689-24

12.37



Peritoneum-Klemmen
 Peritoneum Forceps
 Pincès à péritoine
 Pinzas para peritoneo
 Pinze per peritoneo

KLEMMEN

FORCEPS

PINCES

PINZAS

PINZE

Hysterektomie-Klemmen
 Hysterectomy Forceps
 Pincès à hystérectomie
 Pinzas para histerectomía
 Pinze per isterectomia



12-5691-22

12.38

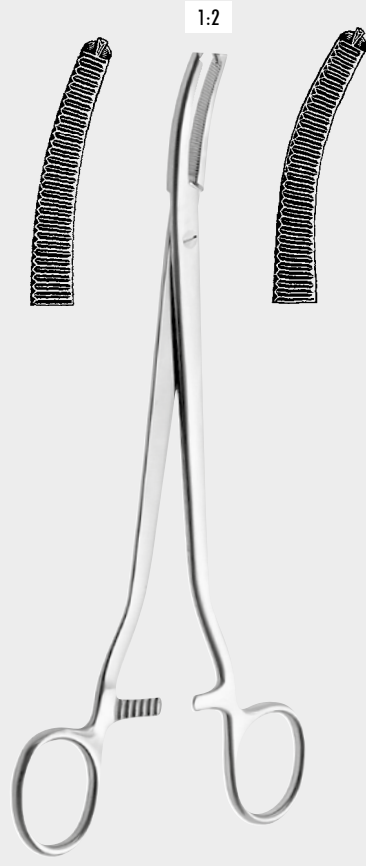

cm	WERTHEIM	
22,0	12-5691-22	12-5693-22
	leicht gebogen	stark gebogen
	slightly curved	strong curved
	courbe légère	courbe forte
	curva ligera	curva fuerte
	curva leggera	curva forte



cm	WERTHEIM	
25,0	12-5695-25	



cm	WERTHEIM	
25,0	12-5701-25	



cm	WERTHEIM	
22,0	12-5703-22	
23,0		12-5705-23
	leicht gebogen	stark gebogen
	slightly curved	strong curved
	courbe légère	courbe forte
	curva ligera	curva fuerte
	curva leggera	curva forte

1:2



cm HOLZBACH
24,5 12-5706-24

1:2



cm HOLZBACH
24,5 12-5707-24

Hysterektomie-Klemmen
Hysterectomy Forceps
Pinces à hystérectomie
Pinzas para histerectomía
Pinze per isterectomia

KLEMMEN

FORCEPS

PINCES

PINZAS

PINZE



cm WERTHEIM-CULLEN
21,5 12-5709-21



atraumatisch
atraumatic
atraumatique
atraumática
atraumatica

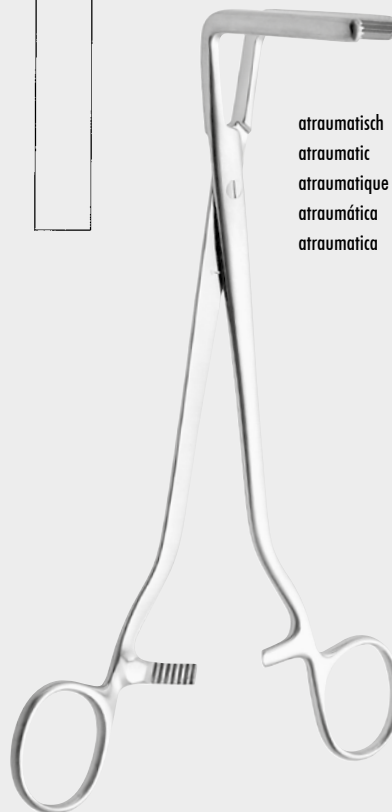

cm WERTHEIM Atrauma
21,0 12-5713-21

ZEPF®
INSTRUMENTS

12-5713-21

12.39



Druck-Klemmen atraumatisch
Pressure Clamps, atraumatic
Pincés clamps à pression atraumatiques
Pinzas clamps de presión atraumáticas
Pinze da pressione atraumatiche

KLEMMEN

FORCEPS

PINCES

PINZAS

PINZE

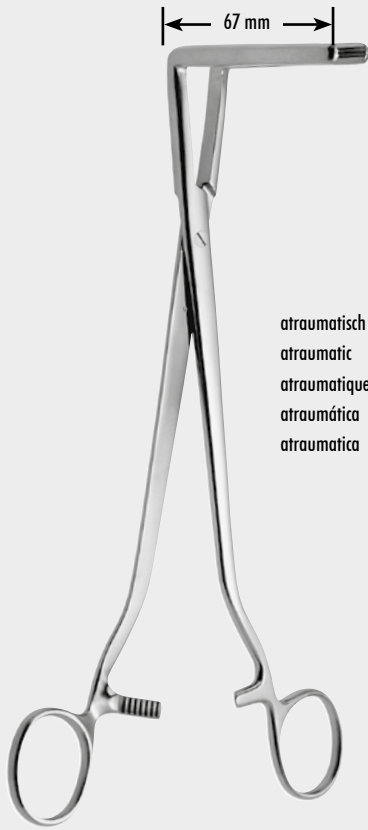

67 mm

atraumatisch
atraumatic
atraumatique
atraumática
atraumatica

cm WERTHEIM
12-5715-08



80 mm

atraumatisch
atraumatic
atraumatique
atraumática
atraumatica

cm WERTHEIM
12-5715-10



atraumatisch
atraumatic
atraumatique
atraumática
atraumatica

DICK Atrauma
12-5721-25 - 12-5721-27

cm
25,0 12-5721-25

cm
26,0 12-5721-26

cm
27,0 12-5721-27

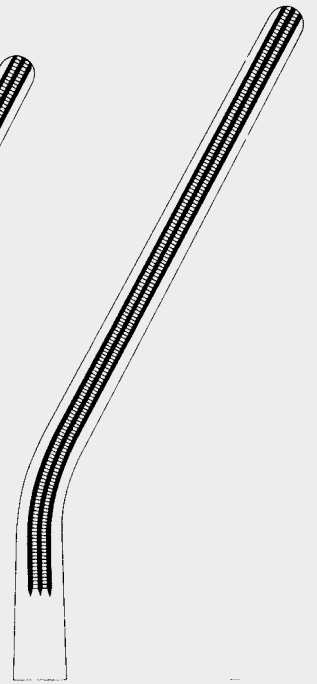
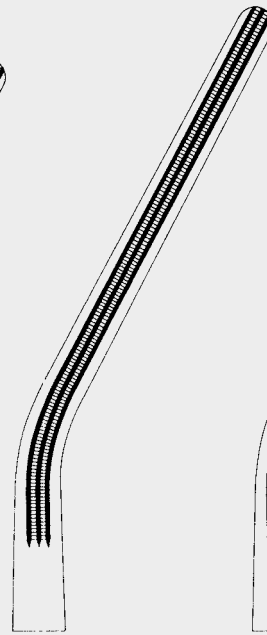
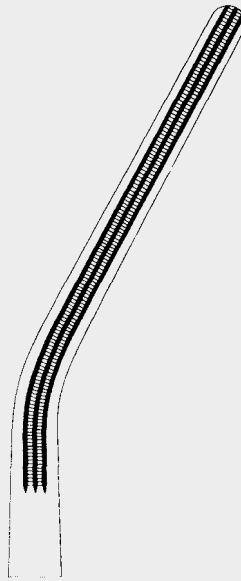

12-5715-08

12.40

atraumatisch
 atraumatic
 atraumatique
 atraumática
 atraumatica

Parametrien-Klemmen atraumatisch
 Parametrium Clamps atraumatic
 Pinces à paramétrium atraumatiques
 Pinzas para parametrio atraumáticas
 Pinze per parametrio atraumatiche



cm
 22,0 12-5730-22



cm
 21,5 12-5731-21

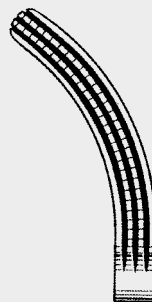

cm
 21,0 12-5733-21

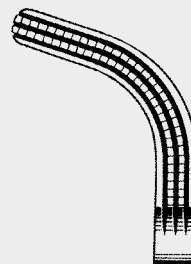

cm
 20,5 12-5735-20

ROGERS (HEANEY)

KLEMMEN

FORCEPS

PINCES

PINZAS

PINZE



12-5730-22 - 12-5745-23



cm
 25,0 12-5740-25

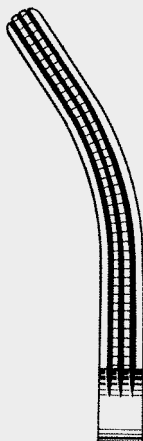

cm
 25,0 12-5741-25

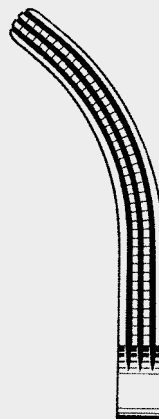

cm
 24,5 12-5743-24

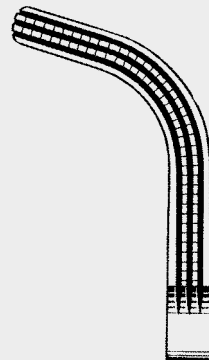

cm
 23,0 12-5745-23

ROGERS (WERTHEIM)

ZEPF[®]

 INSTRUMENTS

12-5745-23

12.41

Parametrien-Klemmen atraumatisch
 Parametrium Clamps atraumatic
 Pincès à paramétrium atraumatiques
 Pinzas para parametrio atraumáticas
 Pinze per parametrio atraumatiche

KLEMMEN

FORCEPS

PINCES

PINZAS

PINZE

atraumatisch
 atraumatic
 atraumatique
 atraumática
 atraumatica



cm	ROBERTS
21,5	12-5800-21
25,5	12-5800-25



cm	ROBERTS
21,5	12-5801-21
25,5	12-5801-25



cm	BURKE
25,0	12-5805-25
35,0	12-5805-35



cm	BURKE
25,0	12-5807-25
35,0	12-5807-35



12-5800-21

12.42

Hysterektomie-Klemmen
 Hysterectomy Forceps
 Pinzas à hystérectomie
 Pinzas para histerectomía
 Pinze per isterectomia



cm HEANEY REZEK
 21,0 12-5904-21

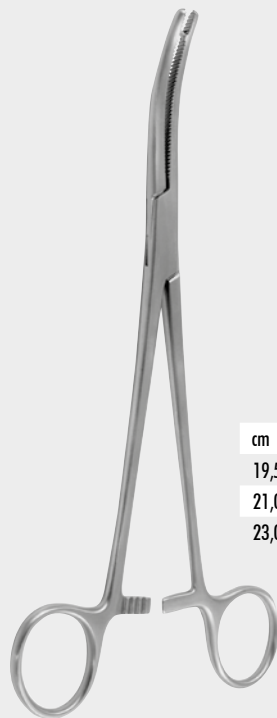

HEANEY
 12-5900-21 - 12-5903-23

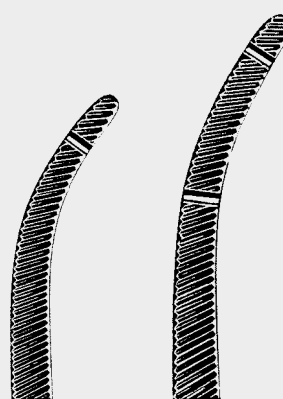

cm	—	—	—
19,5		12-5901-19	12-5903-19
21,0	12-5900-21	12-5901-21	12-5903-21
23,0		12-5901-23	12-5903-23

KLEMMEN

FORCEPS

PINCES

PINZAS

PINZE

1:2



cm GWILLIAM
 20,0 12-5904-20 12-5905-20



cm NAVRATIL
 23,5 12-5907-23

Hysterektomie-Klemmen
 Hysterectomy Forceps
 Pinzes à hystérectomie
 Pinzas para histerectomía
 Pinze per isterectomia

KLEMMEN

FORCEPS

PINCES

PINZAS

PINZE



cm **BONNEY**
 20,5 12-5909-20

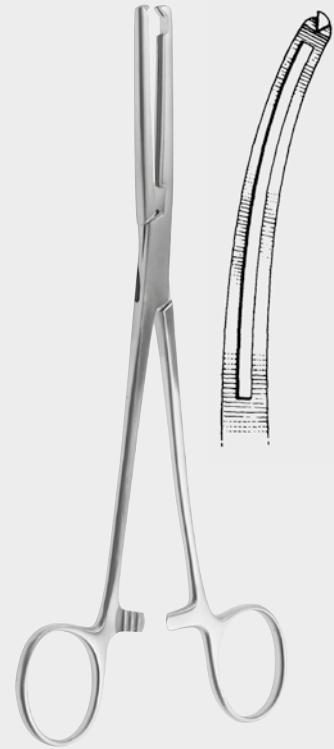

cm **MAINGOT**
 20,0 12-5912-20 12-5913-20
 25,0 12-5913-25



cm **BERKELEY BONNEY**
 19,0 12-5915-19



cm **BONNEY**
 27,0 12-5917-27

ZEPF[®]

 INSTRUMENTS

12-5913-25

12.44



KLEMMEN

FORCEPS

PINCES

PINZAS

PINZE

KORN-, TUPFER- UND SCHWAMMZANGEN

SPONGE AND DRESSING FORCEPS

PINCES À PANSEMENT ET À ÉPONGES

PINZAS PARA TAPONES Y ESPONJAS

PINZE PER MEDICATURA, PER TAMPONI E SPUGNE

Tupferzangen
Dressing Forceps
Pincas à pansements
Pinzas para tapones
Pinze per medicatura

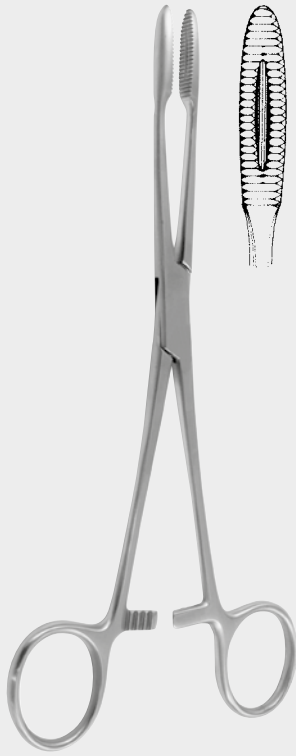

KORN-, TUPFER- UND
SCHWAMMZANGEN

cm	GROSS MAIER	
20,0	16-1100-20	16-1101-20
22,0	16-1100-22	16-1101-22
26,5	16-1100-26	16-1101-26
27,5	16-1100-27	16-1101-27

cm	GROSS MAIER	
20,0	16-1106-20	16-1107-20
26,5	16-1106-26	16-1107-26

cm	GROSS MAIER	
13,0	16-1120-13	16-1121-13
15,0	16-1120-14	16-1121-14
18,0	16-1120-18	16-1121-18
20,0	16-1120-20	16-1121-20
25,0	16-1120-25	16-1121-25

SPONGE AND
DRESSING FORCEPS

PINCES À PANSEMENT
ET À ÉPONGES

PINZAS PARA
TAPONES Y ESPONJAS

PINZE PER MEDICATURA,
PER TAMPONI E SPUGNE



cm	GROSS MAIER	
20,0	16-1124-20	
25,0	16-1124-25	

cm	GROSS MAIER	
20,0	16-1125-20	
25,0	16-1125-25	

cm	GROSS	
14,0	16-1126-14	16-1127-14



16-1100-20

16.2

Tupferzangen
Dressing Forceps
Pincès à pansements
Pinzas para tapones
Pinze per medicatura

KORN-, TUPFER- UND
SCHWAMMZANGEN

SPONGE AND
DRESSING FORCEPS

PINCES À PANSEMENT
ET À ÉPONGES

PINZAS PARA
TAPONES Y ESPONJAS

PINZE PER MEDICATURA,
PER TAMPONI E SPUGNE

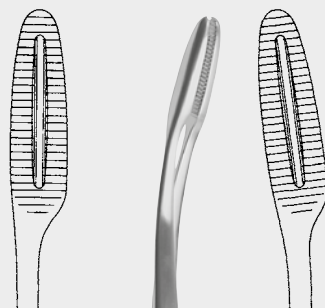

cm		SIMS-MAIER	
28,0	16-1130-28		16-1131-28

cm	MAIER
25,0	16-1134-25

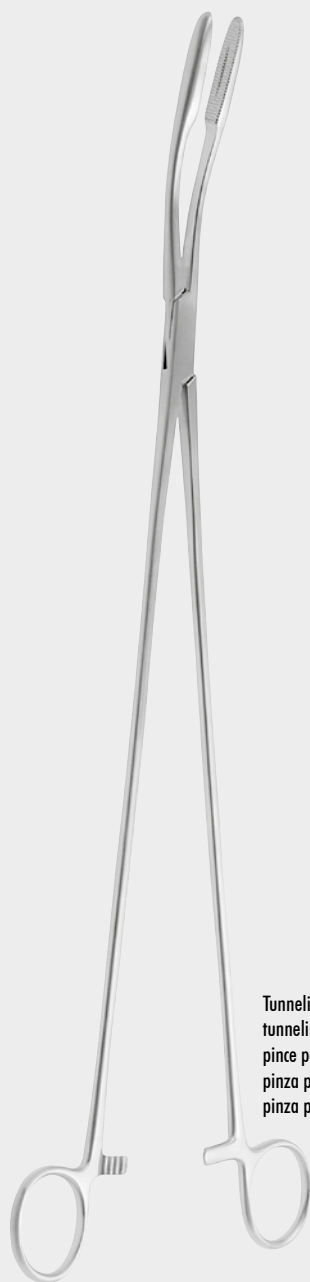

Tunnelier Kornzange
tunneling forceps
pince pour tunnelisation
pinza para tunelar
pinza per tunelare

cm	
39,5	16-1141-39

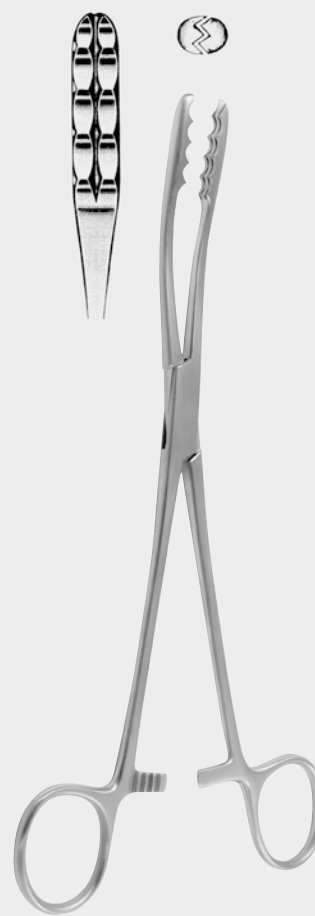
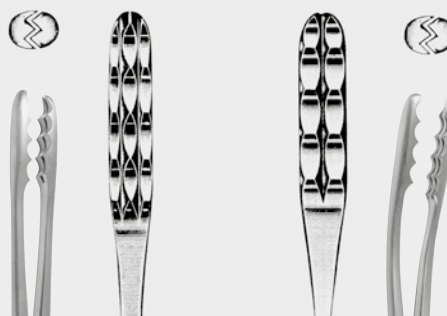

cm		ULRICH	
18,0	16-1600-18		16-1601-18
22,0	16-1600-22		16-1601-22
26,5	16-1600-26		16-1601-26
35,0	16-1600-35		16-1601-35



Schwammzangen
Sponge Holding Forceps
Pincés porte-éponges
Pinzas porta esponjas
Pinze per tamponi e spugne

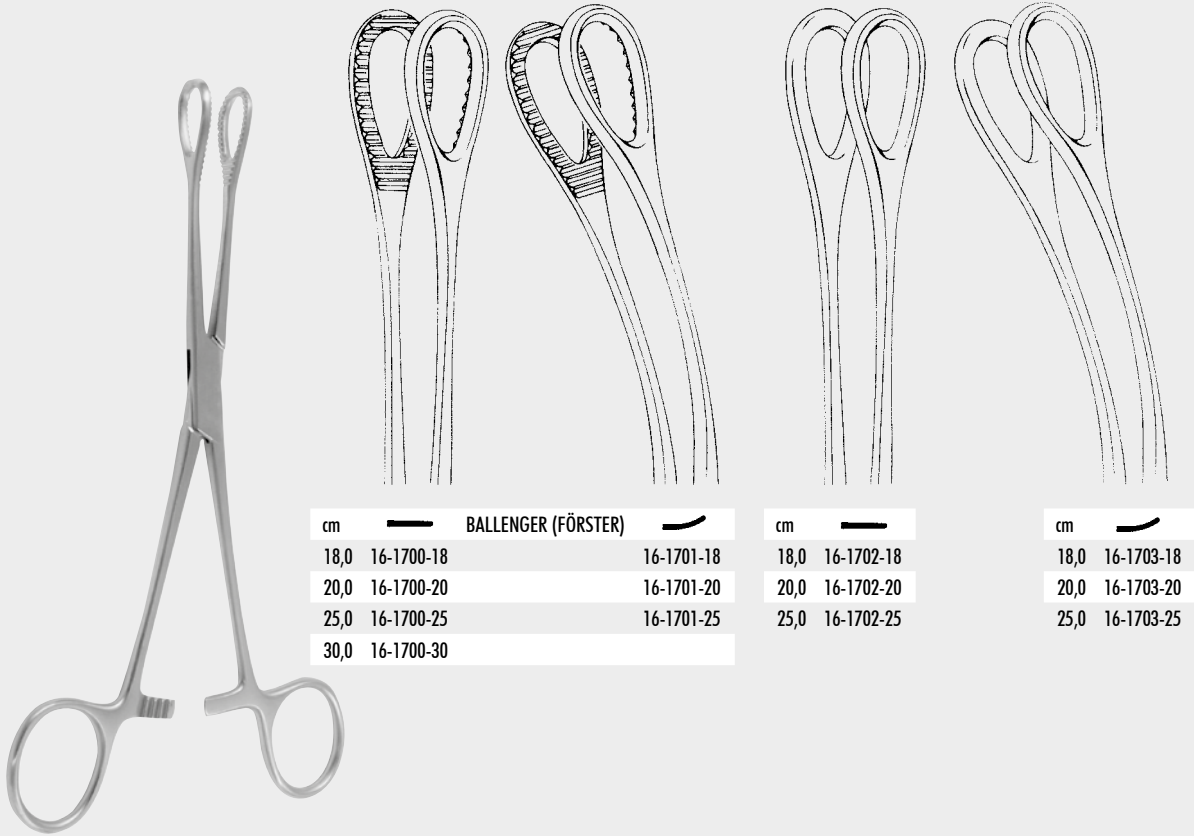

cm	—	BALLENGER (FÖRSTER)	—
18,0	16-1700-18		16-1701-18
20,0	16-1700-20		16-1701-20
25,0	16-1700-25		16-1701-25
30,0	16-1700-30		

cm	—		—
18,0	16-1702-18		16-1703-18
20,0	16-1702-20		16-1703-20
25,0	16-1702-25		16-1703-25

KORN-, TUPFER- UND SCHWAMMZANGEN

SPONGE AND DRESSING FORCEPS

PINCES À PANSEMENT ET À ÉPONGES

PINZAS PARA TAPONES Y ESPONJAS

PINZE PER MEDICATURA, PER TAMPONI E SPUGNE

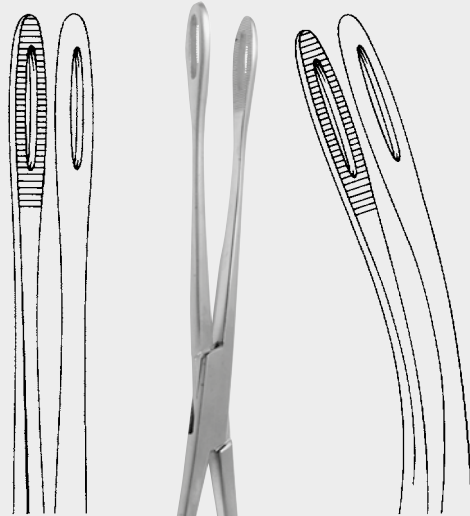

cm —
25,0 16-1704-25

cm —
25,0 16-1705-25



FOERSTER
16-1704-25 - 16-1705-25



cm BONNEY
24,0 16-1706-24



16-1700-18

16.4

Schwammzangen
Sponge Holding Forceps
Pincers porte-éponges
Pinzas porta esponjas
Pinze per tamponi e spugne

KORN-, TUPFER- UND
SCHWAMMZANGEN

SPONGE AND
DRESSING FORCEPS

PINCES À PANSEMENT
ET À ÉPONGES

PINZAS PARA
TAPONES Y ESPONJAS

PINZE PER MEDICATURA,
PER TAMPONI E SPUGNE



cm	RAMPLEY modif.
18,0	16-1708-18
25,0	16-1708-25



cm	VANT
26,5	16-1711-26

ZEPF[®]
α
INSTRUMENTS

16-1711-26

16.5



Schwammzangen
Sponge Holding Forceps
Pincers porte-éponges
Pinzas porta esponjas
Pinze per tamponi e spugne

KORN-, TUPFER- UND
SCHWAMMZANGEN

SPONGE AND
DRESSING FORCEPS

PINCES À PANSEMENT
ET À ÉPONGES

PINZAS PARA
TAPONES Y ESPONJAS

PINZE PER MEDICATURA,
PER TAMPONI E SPUGNE



cm RAMPLEY
25,0 16-1800-25



cm FLETCHER (JAVERTS)
25,0 16-1802-25 16-1803-25



cm BRYANT
13,0 16-2007-13



cm LISTER (Sinus)
13,0 16-2100-13
16,0 16-2100-16
18,0 16-2100-18



cm
24,0 16-2150-24 16-2151-24

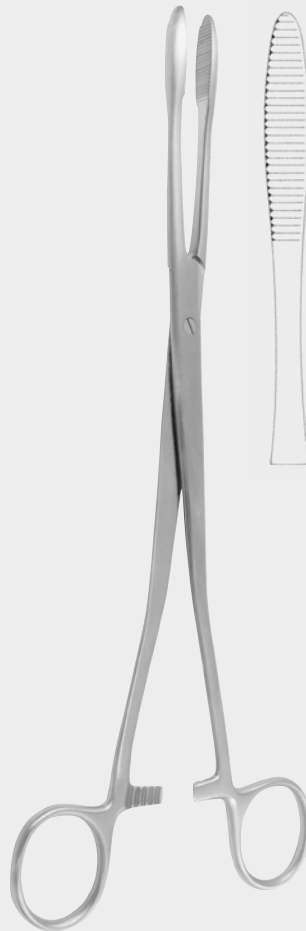

cm COLLIN
25,0 16-2200-25



cm PELKMANN
25,0 16-2206-25 16-2207-25



16-1800-25

16.6

Korn- und Tupferzangen
 Sponge and Dressing Forceps
 Pinces porte-éponges
 Pinzas para tapones
 Pinze per tamponi

KORN-, TUPFER- UND
 SCHWAMMZANGEN

SPONGE AND
 DRESSING FORCEPS

PINCES À PANSEMENT
 ET À ÉPONGES

PINZAS PARA
 TAPONES Y ESPONJAS

PINZE PER MEDICATURA,
 PER TAMPONI E SPUGNE

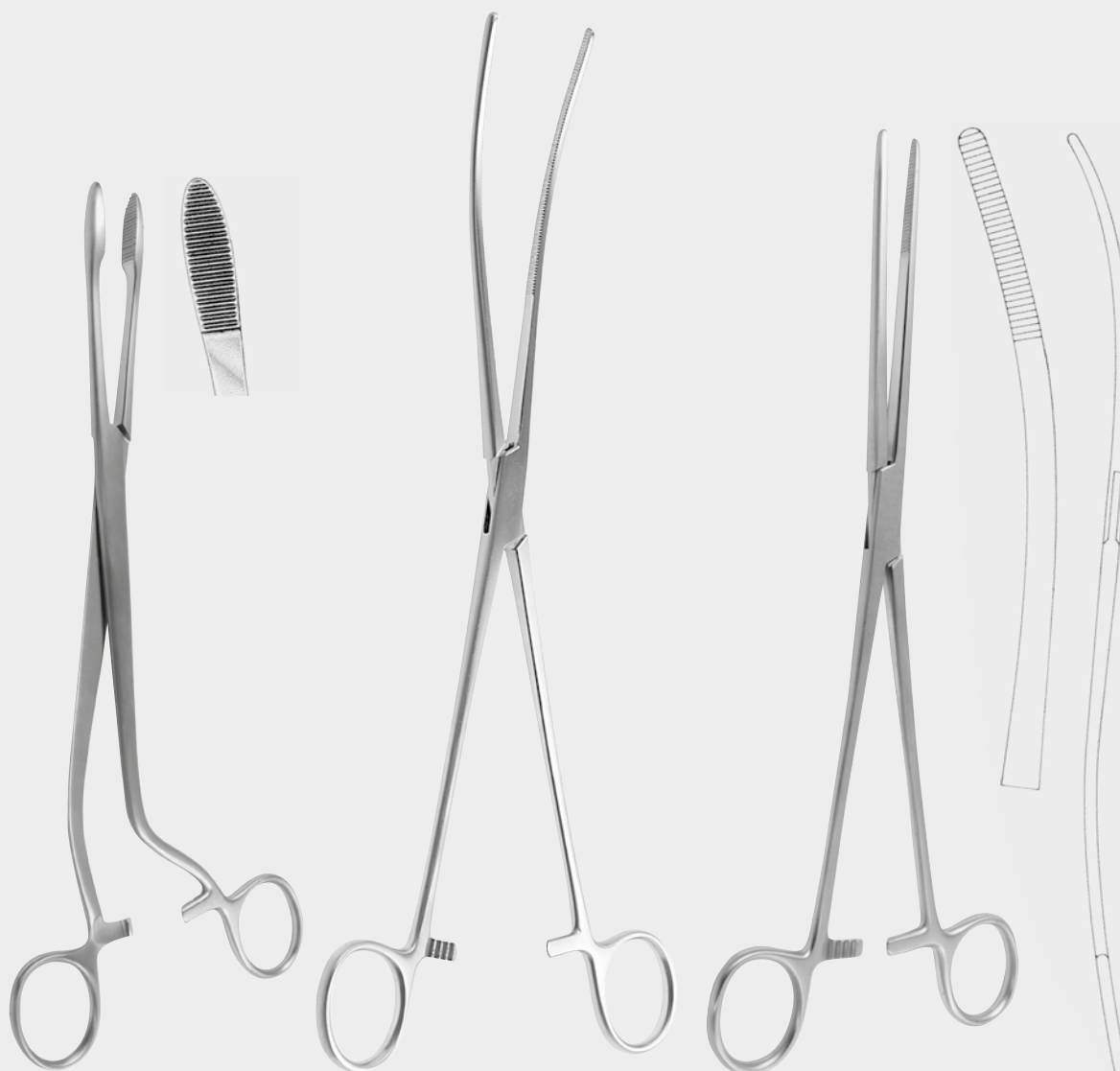

cm **CHERON**
 25,0 16-2209-25

cm **BLUMENTHAL**
 29,0 16-2291-29

cm **BOZEMANN**
 26,0 16-2300-26

16-2301-26
 S-förmig
 S-shape
 forma S
 courbé en S
 curve in forma S



16-2301-26

16.7



Korn- und Tupferzangen
 Sponge and Dressing Forceps
 Pinces porte-éponges
 Pinzas para tapones
 Pinze per tamponi

KORN-, TUPFER- UND
 SCHWAMMZANGEN

SPONGE AND
 DRESSING FORCEPS

PINCES À PANSEMENT
 ET À ÉPONGES

PINZAS PARA
 TAPONES Y ESPONJAS

PINZE PER MEDICATURA,
 PER TAMPONI E SPUGNE



cm BOZEMANN-DOUGLAS
 26,0 16-2303-26

cm EMMET
 22,5 16-2310-22



cm WESTERMARK
 23,0 16-2320-23



cm MARTIN
 17,0 16-2404-17 16-2405-17
 17,0 16-2404-25 16-2405-25



cm DUPLAY
 20,0 16-2406-20 16-2407-20



16-2303-26 - 16-2407-20

16.8